

QST

DEVOTED ENTIRELY TO

AMATEUR RADIO

PUBLISHED SINCE 1915 BY THE AMERICAN RADIO RELAY LEAGUE INC.

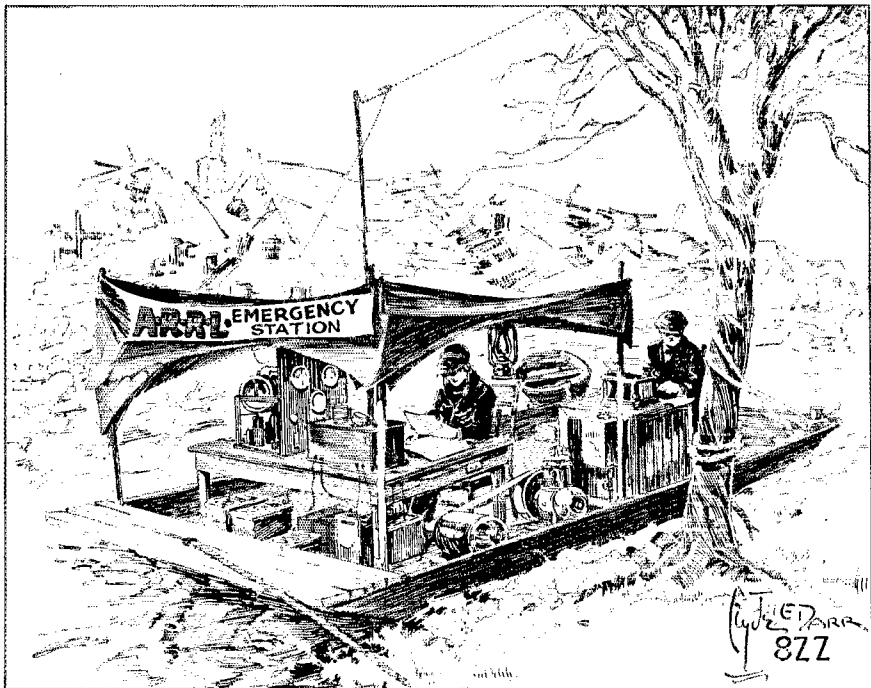

APRIL
1928

25^c

GENERAL RADIO

TRANSMITTING CONDENSERS

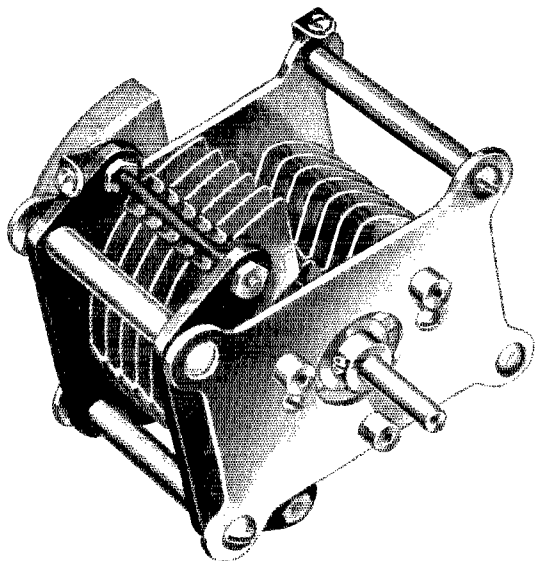

The Type 334-T and V Transmitting condensers have double spacing for use with voltages up to 2000. They are especially adapted for use in short wave transmitters. Plates of both the rotor and stator groups are soldered together to insure perfect electrical contact.

Type 334-T Transmitting Condenser,
Capacity 100 MMF . . . Price \$4.25
Type 334-V Transmitting Condenser,
Capacity 50 MMF . . . Price \$3.75

INTERCHANGEABLE INDUCTANCE and COUPLING COILS

The type 277 Coils are so shaped in the ratio of diameter to length, the material so chosen and the construction such that they have very low losses. Mounting holes are arranged so that the Type 274-P Plugs may be inserted and the coils used interchangeably in the coil mounting bases. Supplied in ranges from 50 to 600 meters also in an unwound coil form. Priced from 75c to \$1.50 according to range.

Type 274-B Mounting base. . . \$1.00

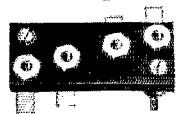
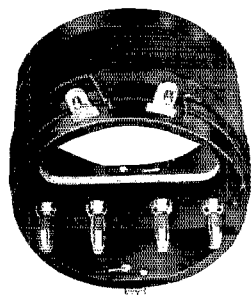

TYPE 277 COIL
with
Mounting Base

GENERAL RADIO Co.

Professional set builders who are unable to secure General Radio apparatus from their local jobbers are reminded that we are prepared to serve them. Write for our latest bulletin No. 923.

30 State St., Cambridge, Mass.

274 Brannan St., San Francisco, Calif.

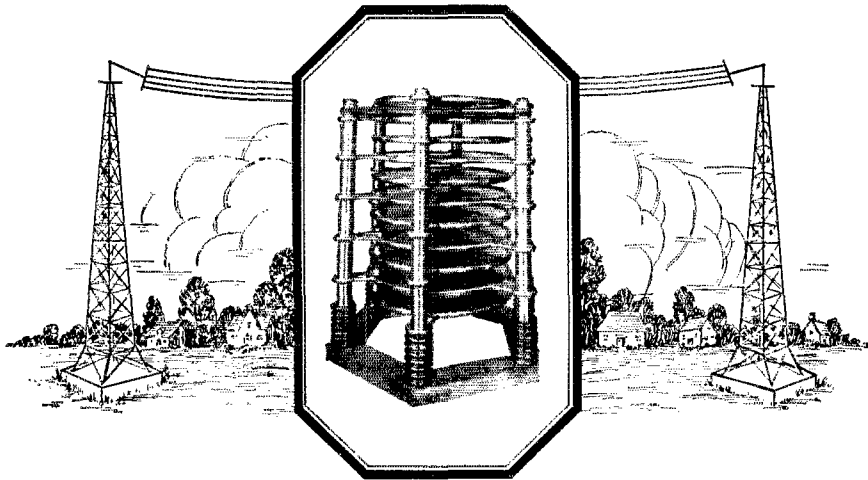

CHAINED LIGHTNING!

ONE of the 60,000 volt air dielectric fixed condensers recently designed and built by CARDWELL for a 50,000 watt broadcasting station. This is believed to be the largest air dielectric condenser ever built by any manufacturer of a standard line of radio condensers or accessories. Especially designed with a view to minimize losses through corona effects. Plates are designed to permit voltages approximately two-thirds higher than could ordinarily safely be used with flat plates.

42 inches high, 30 inches in diameter, weight 375 pounds. Built entirely of polished brass where metal is used.

As the trend among broadcasters seems to be toward increased power, CARDWELL is prepared to furnish similar condensers on special order. Prices on application.

FOR BEST RESULTS ~ CARDWELL FOR CONDENSERS

The rigidity of CARDWELL Taper Plate Condensers makes them particularly well adapted for short wave receivers and low power transmitters. Send for literature.

The Allen D. Cardwell Mfg. Corp.

81 PROSPECT STREET

BROOKLYN, NEW YORK

"THE STANDARD OF COMPARISON"



"I have used ACME Parvoltage Condensers for many years and never have had one break down."

Sw. G. Gready

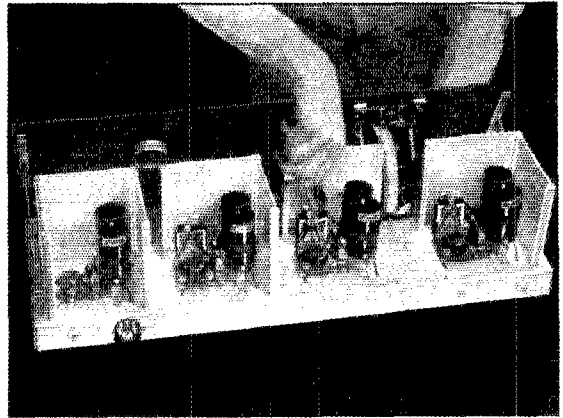

Showing the 10-100000 V. Condensers for A.C. power supply. Also the most parts are supplied in their own boxes including PARVOLT By-Pass Condensers, ACME PARVOLT Filter Condensers and the also recommended for use in the power unit.

Whether You Buy or Build

a Power Supply Unit for Your Radio

PLAY SAFE WITH PARVOLTS!

WHEN you buy an electrified radio or power supply unit for your receiver, look for ACME PARVOLT Condensers; they are your guide to quality in all other parts. They cost the manufacturer a trifle more, but they are both his and your guarantee against costly condenser break-down.

Should you build your own power supply, be sure to use ACME PARVOLT Condensers and be safeguarded against the possibility of break down. Remember that poor filter condensers have caused untold thousands of dollars worth of loss in the past year or two, for blown out condensers mean blown tubes, burned out transformers and frequently the ruination of speaker units.

Just as PARVOLT By-Pass Condensers have been used for years in high grade

receivers, so are PARVOLT Filter Condensers rapidly replacing ordinary condensers in electrified radio. These condensers are wound with the very finest insulating papers combined with highest grade foils. Every detail produced in one of America's most

modern plants and under the supervision of experts in condenser design and manufacture.

Uniformity of capacity and uniformity of sizes are two big features. Accuracy of all ratings, based upon the R.M.A. standards, is another guarantee of uninterrupted service. Play safe with PARVOLTS!

Made by THE ACME WIRE CO., New Haven, Conn., manufacturers of magnet and enamelled wire, varnished insulations, coil windings, insulated tubing and radio cables.

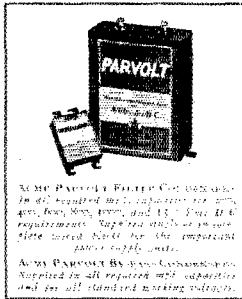

ACME PARVOLT Filter Condensers are available in all ratings from 100 to 100,000 v. per sec. 500, 1000, and 15,000 v. per sec. All requirements. They are available in all ratings. Write for literature and the important price list only.

ACME PARVOLT By-Pass Condensers are supplied in all required ratings and are available in all standard mounting voltages.

ACME PARVOLT CONDENSERS

Made by the Manufacturers of

ACME CELATSITE WIRE

INDOOR AERIAL and LOOP WIRE

Available in all sizes from 1/8 inch diameter and 1/4 inch diameter. Also Acme Leads and Battery Cables.

CELATSITE FLEXIBLE and SOLID

For all types of radio wiring. High insulation value, non-inflammable, no odor.

ACME SPAGHETTI

A superior vacuum tubing for all practical radio and other electrical requirements. Supplied in all sizes.



Section Communications Managers of THE COMMUNICATIONS DEPARTMENT, A. R. R. L.

Eastern Pennsylvania 78BU
Maryland-Delaware-District of Columbia 7ABR
Southern New Jersey 30FG
Western New York 8PJ
Western Pennsylvania 8XE

Illinois 9AAW
Indiana 90YU
Kentucky 8ARU
Michigan 8CRP
Ohio 8BYN
Wisconsin 8VD

North Dakota 9EFN
South Dakota 9DB
North Minnesota 9EGU
South Minnesota 9BYA

Arkansas 5AIP
Louisiana 5UK
Mississippi 5AKP
Tennessee 4KM

Eastern New York 2ADH-2AXR
N. Y. C. & Long Island 2CWR
North New Jersey 2WR

Iowa 9RKV
Kansas 9DNG
Missouri 9RB
Nebraska 9BYG

Connecticut 1BM
Maine 1BQ
Eastern Massachusetts 1UE
Western Massachusetts 1DB
New Hampshire 1ATY
Rhode Island 1BVB
Vermont 1AJG

Alaska* 7DE
Idaho 7SP-7ALD
Montana 7AAT-7QT
Oregon 7PP
Washington 7FD

Hawaii 6CFQ
Nevada 6UO
Los Angeles 6AM
Santa Clara Valley 6NX
East Bay 6GZB
San Francisco 6VR
Sacramento Valley 6CRS
Arizona 6ANO
Philippines* 6LAT
San Diego 6BQ

North Carolina 4JR
Virginia 3CA
West Virginia 3HD

Colorado 9CAA
Utah-Wyoming 6RM

Alabama 5AJP
Florida 4LK
Georgia-South Carolina-Cuba-Porto Rico-Isle of Pine 4KU

Northern Texas 5AKN
Oklahoma 5APG
Southern Texas 5VK
New Mexico 3TT

Newfoundland 8AR
New Brunswick 1EI
Nova Scotia 1DD
Prince Edward Island 1BZ

Ontario 9BJ
Quebec 2BE

Alberta 4GT
British Columbia 5BJ

Manitoba 4FV
Saskatchewan 4FC

ATLANTIC DIVISION

E. L. Maneval 1470 W. Fourth St. Williamsport, Pa.
Dr. H. H. Layton 805 Washington St. Wilmington, Del.
M. J. Lotvsh Box 49, RFD 1. Chantury, N. J.
C. S. Taylor 598 Masten St. Buffalo
G. L. Crossley State College

CENTRAL DIVISION

W. E. Schweitzer 4264 Hazel Ave. Chicago
D. J. Angus 310 N. Illinois St. Indianapolis
D. A. Downard 116 No. Longworth Ave. Louisville
Dallas Wise 9187 Falcon Ave. Detroit
H. C. Storck 694 Carpenter St. Columbus
C. N. Crapo 443 Newton Ave. Milwaukee

DAKOTA DIVISION

G. R. Moir 618 11th Street, South Fargo
F. J. Beck Milbank
C. L. Barker Fenning
D. P. Cottam 3538 Third Ave. So. Minneapolis

DELTA DIVISION

Leonard Chippard 2408 North Pierce St. Little Rock
C. A. Freitag 129 Camp St. New Orleans
J. W. Gullett 1708 23rd Ave. Meridian
L. K. Rush 4 Second St. Bemis

HUDSON DIVISION

Earle Pearce Box 113 Yonkers
F. H. Mardon 1309 W. Farms Rd. N. Y. C.
A. G. Wester, Jr. 59 Princeton St. Maplewood

MIDWEST DIVISION

A. W. Kruse Rt. 6, Box 19 Akron
F. S. McKeever 1325 W. Campus Rd. Lawrence
L. B. Laizure 8010 Menier St. Kansas City
C. B. Deihl 5605 Cedar St. Omaha

NEW ENGLAND DIVISION

H. E. Nichols 82 Elmwood Ave. Bridgenort
Frederick Best 18 E. Crescent St. Augusta
E. L. Battey 39 Royal St. Wollaston
A. H. Carr 30 Vassar St. Worcester
V. W. Hodge 227 Main St. Claremont
D. R. Fancher 22 Summer St. Westley
C. T. Kerr Poultney

NORTHWESTERN DIVISION

L. H. Machin Box 452 Cordova
Henry Fletcher 1610 N. 10th St. Boise
O. W. Viers Red Lodge
M. H. Wright 310 Ross St. Portland
Otto Johnson 4340 30th Ave. W. Seattle

PACIFIC DIVISION

F. L. Fullaway 2714 Manoa Rd. Honolulu
C. R. Newcombe Yerington
D. C. Wallace 109 W. Third St. Long Beach Calif.
F. J. Quement 252 Hanchett Ave. San Jose
J. Walter Prates, 368 62nd St. Oakland
J. W. Patterson 1338 7th St. San Francisco
G. F. Mason 2530 N. St. Sacramento
D. B. Lamb 329 W. First St. Mesa
Jose E. Jimenez 835 San Fernando St. Manila
G. A. Sears 236 Bonair St. La Jolla

ROANOKE DIVISION

R. S. Morris 413 S. Broad St. Gastonia
J. E. Wohlford 118 Cambridge Ave. Roanoke
C. S. Hoffman 126 Chantal Court Wheeling

ROCKY MOUNTAIN DIVISION

C. R. Stedman 1641 Albion St. Denver
Don C. McRae 214 Belvedere Apts. Salt Lake City

SOUTHEASTERN DIVISION

A. D. Trum 217 Catoma St. Montgomery
C. E. Ffoulkes 502 Spearing St. Jacksonville
H. L. Reid 11 Shadowlawn Ave. Atlanta

WEST GULF DIVISION

J. H. Robinson, Jr. 522 Cumberland St. Dallas
K. M. Ehret 2904 N. Robinson St. Oklahoma City
E. A. Sahn 146 N. Academy St. New Braunfels
I. E. Radka Tucumcari

MARITIME DIVISION

Loyal Reid Avalon House St. Johns
T. B. Lacey c/o N. R. Power Co. St. John
W. C. Borrett 14 Sinclair St. Dartmouth
F. W. Hyndman 25 Fitzroy St. Charlottetown, P. E. I.

ONTARIO DIVISION

W. Y. Sloan 167 Close Ave. Toronto

QUEBEC DIVISION

Alex Reid 169 Lozan Ave. St. Lambert

VANALTA DIVISION

A. H. Asmussen 10723 111th Ave. Edmonton
E. S. Brooks c/o Forestry Dept. Radio Court House, Vancouver

PRAIRIE DIVISION

D. B. Sinclair 205 Cambridge St. Winnipeg
W. J. Pickering 514 19th St. W. Prince Albert

*Temporary officials appointed to act until the membership of the Section concerned choose permanent SCMs by the nomination and election.



Before newspapers were common, news of immediate importance was cried through the streets by a town official called a "Crier."



Get it Better with a Grebe

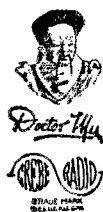

Born with a heritage of 19 years of outstanding radio leadership, endowed with tonal beauty, selectivity and ease of operation, the Grebe Synchronphase A-C Six is presented—the newest member of a famous family.

This receiver uses A-C (alternating current) tubes and entirely eliminates batteries and socket power units. Just plug into the light socket and listen.

Incomparable range and selectivity—single illuminated dial—freedom from A-C hum—maximum volume without distortion and other new Grebe improvements enable you to

get better local and distance reception.

The Grebe Synchronphase A-C Six is truly the battery-less set for which you have been waiting. Hear it to-day. Then you will have a complete demonstration of what expert, painstaking radio engineering can accomplish.

Grebe Natural Speaker (illustrated), \$35; Grebe No. 1750 Speaker, \$17.50. Where alternating current is not available, the Synchronphase Seven, \$135; or the Synchronphase Five, \$95. You will be interested in Booklet Q which fully explains the new Grebe A-C Six. Sent upon request.



GREBE

SYNCHROPHASE
TRADE MARK REG. U.S. PAT. OFF.

A-C Six

RADIO

A. H. Grebe & Company, Inc., 109 West 57th Street, New York City

Factory: Richmond Hill, N. Y.

Western Branch: 443 So. San Pedro St., Los Angeles, Calif.

Makers of quality radio since 1909



QST



The Official Organ of the A.R.R.L.

VOLUME XV

APRIL, 1928

NUMBER 4

| | |
|---|----|
| Editorials | 7 |
| Official Wavelength Stations | 8 |
| Some Investigations of Short Waves at Nijni-Novgorod <i>Wladyslaw W. Crzybowski</i> | 9 |
| A.R.R.L. Technical Information Rules | 14 |
| Standard Frequency Transmissions from 9XL | 14 |
| Low-Power, Flexible Crystal-Control for Four Amateur Bands . <i>S. P. McMinn</i> | 15 |
| The A.R.R.L. Board Meets | 21 |
| Notes on the Design of Iron-Core Reactances Which Carry Direct Current | |
| <i>D. E. Replogie</i> | 23 |
| A Transmitter Without Transformers | 28 |
| <i>I. W. Hatry</i> | 28 |
| Standard Frequency Transmissions from WWV | 28 |
| Designing Fixed Resistors | 29 |
| <i>R. C. Hitchcock</i> | 29 |
| SDPO | 32 |
| The UX-250—CX-350 Tube | 36 |
| Keying Master-Oscillator Circuits | 37 |
| <i>Beverly Dudley</i> | 37 |
| Easy Tuning in Short-Wave Bands | 39 |
| <i>F. Austin Lidbury</i> | 39 |
| Financial Statement | 40 |
| A Portable Receiver | 41 |
| <i>James J. Lamb</i> | 41 |
| Variable A-, B- and C-Power from D. C. Mains | 43 |
| <i>F. I. Anderson</i> | 43 |
| Experimenters' Section Report | 44 |
| Communications Department | 46 |
| I.A.R.U. News | 58 |
| Calls Heard | 59 |
| Correspondence | 60 |
| West Gulf Division Convention | 88 |
| Hamads | 91 |
| QRAS | 93 |
| Index of Advertisers | 94 |

QST is published monthly by The American Radio Relay League, Inc., at Hartford, Conn., U. S. A.
Official Organ of the A.R.R.L. and the International Amateur Radio Union

Kenneth B. Warner (Secretary, A.R.R.L.),
Editor-in-Chief and Business Manager

F. Cheyney Beekley,
Managing Editor and Advertising Manager

Robert S. Kruse,
Technical Editor

Harold P. Westman,
Assistant Technical Editor

David H. Houghton,
Circulation Manager

Subscription rate in United States and Possessions, Canada, and all countries in the American Postal Union, \$2.50 per year, postpaid. Single copies, 25 cents. Foreign countries not in American Postal Union, \$3.00 per year, postpaid. Remittances should be by international Postal or express money order or bank draft negotiable in the U. S. and for an equivalent amount in U. S. funds, entered as second-class matter May 29, 1919, at the post office at Hartford, Connecticut, under the act of March 3, 1879. Acceptance for mailing at special rate of postage provided for in section 1103, Act of October 3, 1917, authorized September 9, 1922. Additional entry as second-class matter, acceptable at special rate of postage provided for above, at Springfield, Mass., authorized September 17, 1924.

Copyright 1928 by the American Radio Relay League, Inc. Title registered at United States Patent Office.
Member of the Radio Magazine Publishers' Association.

The American Radio Relay League

The American Radio Relay League, Inc., is a non-commercial association of radio amateurs, bonded for the promotion of interest in amateur radio communication and experimentation, for the relaying of messages by radio, for the advancement of the radio art and of the public welfare, for the representation of the radio amateur in legislative matters, and for the maintenance of fraternalism and a high standard of conduct.

It is an incorporated association without capital stock, chartered under the laws of Connecticut. Its affairs are governed by a Board of Directors, elected every two years by the general membership. The officers are elected or appointed by the Directors. The League is non-commercial and no one commercially engaged in the manufacture, sale or rental of radio apparatus is eligible to membership on its board.

"Of, by and for the amateur", it numbers within its ranks practically every worth-while amateur in the world and has a history of glorious achievement as the standard-bearer in amateur affairs.

Inquiries regarding membership are solicited. A bona fide interest in amateur radio is the only essential qualification; ownership of a transmitting station and knowledge of the code are not prerequisite. Correspondence should be addressed to the Secretary.

Directors

President
HIRAM PERCY MAXIM
Drawer 2102,
Hartford, Conn.

Vice-President
CHARLES H. STEWART
St. David's, Pa.

Canadian General Manager
A. H. K. RUSSELL
5 Mail Bldg.,
Toronto, Ont.

Atlantic Division
DR. EUGENE C. WOODRUFF
234 W. Fairmount Ave.,
State College, Pa.

Central Division
CLYDE E. DARR
137 Hill Ave., Highland Park,
Detroit, Mich.

Dakota Division
C. M. JANSKY, JR.
Dept. of Elec. Eng., U. of M.,
Minneapolis, Minn.

Delta Division
BENJ. F. PAINTER
424 Hamilton Nat'l Bank Bldg.,
Chattanooga, Tenn.

Hudson Division
DR. LAWRENCE J. DUNN
480 East 19th St.,
Brooklyn, N. Y.

Midwest Division
PORTER H. QUINBY
817 Lauderman Building,
St. Louis, Mo.

New England Division
DR. ELLIOTT A. WHITE
Dartmouth College,
Hanover, N. H.

Northwestern Division
E. W. WEINGARTEN
3219 No. 24th St.,
Tacoma, Wash.

Pacific Division
ALLEN H. BABCOCK
65 Market St.,
Southern Pacific Co.,
San Francisco

Roanoke Division
W. TREDWAY GRAVELY
Box 245,
Danville, Va.

Rocky Mountain Division
PAUL M. SEGAL
c/o District Attorney
West Side Court Bldg.,
Denver, Colo.

Southeastern Division
HARRY F. DOBBS
c/o Dobbs & Wey Co.,
Atlanta, Ga.

West Gulf Division
FRANK M. CORLETT
2515 Catherine St.,
Dallas, Tex.

Officers

President HIRAM PERCY MAXIM, Hartford, Conn.
Vice-President CHAS. H. STEWART, St. David's, Pa.
Secretary KENNETH B. WARNER, Hartford, Conn.
Treasurer ARTHUR A. HEBERT, Hartford, Conn.
Communications Manager . . . F. EDWARD HANDY, Hartford, Conn.

Address General Correspondence to Executive Headquarters, Hartford, Conn.

EDITORIALS

THE Washington Convention of 1927, embodying the results of the recent international radiotelegraph conference, will offer many grave problems for amateur radio when it becomes effective the first of next year. We have said that amateur radio can find a way to get along satisfactorily under this convention and that in fact the necessity of hitching up our jeans and tackling some really difficult jobs is going to act as a spur to new effort which will put a tremendous zest in the old game. It is now time we set about the solution of some of these problems. Admittedly it won't be possible to foresee all of them. Some of them can't be planned for until they crop up next year. But many of them can be foreseen and these we should plan for now, perfecting our arrangements during the balance of 1928 so that we can carry on smoothly next year under the new regulations.

The problems are introduced by the operating restrictions of the new convention: the narrowing of amateur bands and the fact that the amateurs of every country will have to operate in the same bands. The difficulties are of two major sorts: technical problems and operating problems. The technical problems are those brought about by the necessity for many thousands of stations operating in the same restricted bands, making it essential that we achieve an altogether different order of stability of frequency, sharpness of wave, goodness of note and precision of adjustment in our transmitters than we have had in the past; an altogether different order of accuracy of reading in our frequency-meters; an altogether different order of selectivity and precision of control in our receivers. These are jobs which should be whipped during 1928, so that we will be ready for the new conditions when they come. They are jobs for *QST*, and *QST* is setting about their solution, of which we shall have more to say soon.

The difficulties of the other sort are those that we shall still have even after we have vastly improved transmitters and receivers: operating difficulties brought about by the fact that we amateurs of every country are put in the same bands. It becomes necessary to think about the purposes for which we should use our various bands and how we may introduce a certain measure of coöperation in their use

so as to insure satisfactory communication. The problems of this latter class came in for a lot of heavy thinking at the recent meeting of our A. R. R. L. Board of Directors and finally resulted in the adoption of some policies. These are here set forth for the dual purpose of informing the A. R. R. L. membership and of seeking the coöperation of the amateurs of all the world.

Long-distance international communication is almost the greatest single amateur interest. It is not the most vital amateur activity but it is very important. It must be preserved. With the amateurs of every country assigned the same wavebands, it is apparent that coöperation amongst ourselves is imperative if we are to have international contact. The A. R. R. L. Board is convinced that a friendly division of the international amateur waves is desirable in the interests of international communication and wishes to propose a plan to that end, a plan under which the amateurs of each continent agree, even if assigned the full width of the international bands by their governments, to confine their transmissions to a certain part of the bands and to stay clear of other parts that are used for transmission from other continents. If this is done we shall have international QSO if we can achieve enough selectivity to work our man through the interference of other stations of his continent. If it is not done, international DX will be just about hopeless through the QRM of all the world, including our own continent. Amateurs are human; their observance of any plan will be imperfect, either from technical inability or normal human frailty; but it is our one chance to preserve DX, the one way out, and we must try it. There is another very important angle. Many of the less liberally disposed governments may not assign their amateurs the full width of the amateur international bands but only a fraction thereof. These small assignments, left to the vagaries of governments, could easily be so unrelated as to produce a condition of mutual interference under which the amateurs of two important countries would never be able to achieve communication. On the other hand, with a definite plan to work towards the amateur societies of the world could ask their governments for assignments that at least included the frequencies sug-

gested for that country in an international cooperative scheme. Hence the added importance of developing a plan now, so that there may be time to take care of this important matter.

The international amateur bands are the 40-meter band and the 20-meter band. DX of course is possible on the 80-meter band too, but that will be needed for domestic communication and the A. R. R. L. proposes the plan of division only for the two shorter-wave bands. It adopts the territorial subdivision suggested by the I. A. R. U.: Europe, North America, and "the rest of the world", and suggests that in both the 40-meter and 20-meter bands the amateurs of North America work in the long-wave half of the band, the amateurs of Europe in the bottom quarter, and the amateurs of the rest of the world in the intermediate quarter of the band. Let us tabulate this and put it in terms of frequency:

| 40-meter band | | 20-meter band |
|-----------------|-----------------------------|-------------------|
| 7,000-7,150 kc. | North America | 14,000-14,200 kc. |
| 7,150-7,225 kc. | Rest of world except Europe | 14,200-14,300 kc. |
| 7,225-7,300 kc. | Europe | 14,300-14,400 kc. |

This is not a perfect plan but it is the best that it has been possible to devise. It does offer hope, and there is no hope without a plan. More elaborate subdivision seems impracticable in an initial plan; practice will indicate the desirability and practicability of modifications that will meet further need. It is thought that this plan does meet the major needs of the situation. The amateurs of North America are sufficiently interested in having good international contact to propose to stay out of half of the available frequencies

which certainly should be accepted as fair enough by the amateurs of the other countries when it is realized that North America has three times as many amateurs as the rest of the world combined. The League proposes this plan for the consideration of amateurs in other countries and offers, if it is acceptable, to recommend to American amateurs that they keep their transmitters clear of the waves used by other nations, so that international QSO may be possible.

The League recommends to the amateurs of the world that the 80-meter band be considered as primarily a national and intra-continent band, for what might be called domestic communication, and that it not be the subject of an international agreement. It recommends that the 40-meter and 20-meter bands be considered as primarily for long-distance international work, and that, because of the great congestion they will suffer, they be used for intra-continent work only on distances of over 1,500 miles. The League does not suggest that any of these proposals be incorporated in law or regulation anywhere, but that they be adopted purely as a basis for organized cooperation. In sponsoring this plan the League feels that some friendly agreements on the international waves are essential and it believes that the suggestions herein related are best calculated to produce the desired results. By this article and by letters which are being written to national amateur societies it lays this plan before the amateurs of the world as the best and fairest plan it is able to devise, earnestly urging its acceptance, and awaiting and soliciting comment and reaction from amateurs everywhere.

K. B. W.

Official Wavelength Stations

THE Official Wavelength System furnishes a service cooperative with, but differing from, that of the Standard Frequency Stations 9XL and 1XM, which are also operated in accordance with plans made with the O.W.L.S. Committee. Contact with the O.W.L.S. is through Mr. D. C. Wallace, 6AM, who is also chairman of the committee. Mr. Wallace is continuing the practice of checking up all O.W.L.S. to make sure that they are really indicating their wavelength (or frequency) at the end of each transmission—and are doing so with proper accuracy; which is to say 2%. They do this in the course of regular operation and do not send calibration schedules as do the S.F. stations.

The list is as follows:

1AAC, 1AVW, 1AWW, 1BHW, 1BZQ, 1CCW, 1CK, 1KP, 1ZL, 1ZO, 2CLA, 2DS, 2MU, 2SZ, 2XI, 3APV, 3BE, 3XW, 4LK, 5AGN, 5AKN, 5EW, 5MN, 5OX, 5PH, 5SP, 5XBH, 5ZAV, 6AKW, 6AM, 6BB, 6BCP, 6BGM, 6BMW, 6BQB, 6CAE, 6CMQ, 6CVO, 6LJ, 6QL, 6SX, 6TI, 6TS, 6XAG, 6XAQ, 6ZE, 6ZZH, 6ZV, 7AGI, 7BE, 7BU, 7GQ, 7NX, 7QK, 7XF, 7ZX, 8AA, 8APZ, 8BAU, 8BZT, 8EQ, 8GU, 8GZ, 8XC, 8ZG, 9AXQ, 9BCH, 9BGK, 9BMR, 9CPM, 9CXU, 9DXN, 9EFO, 9EGU, 9ELB, 9FF, 9IG, nc1AE, nc2BE, nc3CO, nc3NI, nc3FC, nc4BT, nc9AL, eg2OD, eg2SE, Ireland 5NJ, oa2CM and oz2AC. Crystal Controlled O.W.L.S.: NKF, 1AXA, 2BO, 2BRB, 2EF, 2WC, 4BY, 4XE, 6AOI, 6DLL, 8CMM, 8DAJ, 9AUG, 9BVH, 9UZ-NRRL, 9ZA, eg2NM, eg5LF and oa5BG. Standard Frequency Stations: 1XM and 9XL.

Some Investigations of Short Waves at Nijni-Novgorod

By Wladyslaw W. Grzybowski*

EARLY in 1925 a series of experiments on short-wave propagation was begun with the main objective of clearing up the best ratio between fundamental and working waves of an aerial and in the meantime to try out a transmitter using a large power such as 25-50 kilowatts.

The theoretical diagram (Fig. 1) shows that the oscillator consisted of two 500-watt valves type G. O. and a 25-kilowatt amplifier valve especially designed for the experiments. The circuit is symmetrical Hartley. Grid leak R_1 is connected directly to the center tap on the coil L_1 and consists of leak only without shunting capacity. Condenser C_1 compensates some asymmetry of the oscillating circuit L_1-C_1 due to both plates of C_1 being not in the same capacitive coupling with the earth. The amplifier is coupled to the points A and B of the coil L_1 . R_2 is the grid leak of the amplifier tube. The anode potential of the latter comes from a mercury arc rectifier giving 7000 volts. There are resistors of 100, 300 and 400 ohms in series with the plate supply.

was 4.58; at 102 met $R_o/R=3.73$, and with antenna shortened a little so as to be 78 meters long and $\lambda=104$ M. it was found that $R_o/R=3.00$.

The antenna current was about 11

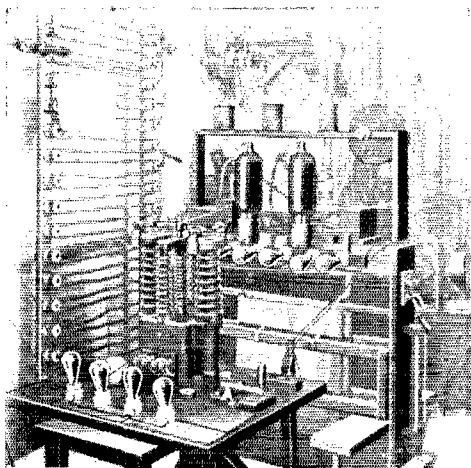

A. THE FIRST TEST TRANSMITTER AT NIJNI-NOVGOROD CORRESPONDING TO THE DIAGRAM ON FIG. 1

This set worked in the 80- to 100-meter range and established contact with the South America and Australia in 1925.

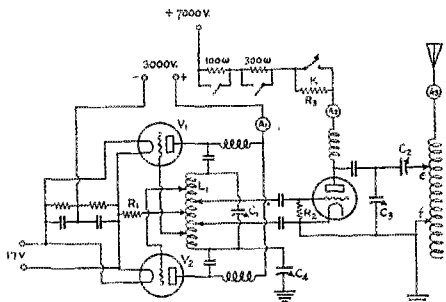

FIG. 1. DIAGRAM OF THE FIRST TEST TRANSMITTER AT NIJNI-NOVGOROD

Two 500-watt type G. O. oscillators working push-pull in a symmetrical Hartley circuit feed the single 25-kilowatt amplifier which is directly coupled to the antenna. Resistances in the 7000-volt plate supply of the amplifier regulate the power output.

Usually the circuit worked with the 100-ohm resistor. For keying, the Klifden's relay (K) was employed in the plate lead of the power amplifier.

A single vertical wire $2\frac{1}{2}$ mm. in diameter strung between two poles 95 meters high served as an aerial and with the wavelength 83 meters the R_o -to- R ratio

amperes and it was noticed that with antenna current larger the wave became unsteady.

The intermediate filter circuit consists of condensers C_2 and C_3 and the E-F part of the antenna coil.

The experiments showed that signals were very steady, easy to read, very strong and covered the whole globe. For instance, New Foundland reported signals to be much stronger than those of nearby American stations and San Juan (Porto Rico) reported signals such as to "deaden" the locals.

The experiments proved that the power of the transmitter was more than sufficient to make consistent American-Europe communication possible although it was not possible at that time to point out the best ratio of R/R_o at different distances and with different angles of radiation. At the same time it was obvious that in order to obtain regular contact with a distant point over the whole 24 hours of the day the

*r1WX c/o State Bank, Nijni-Novgorod, U. S. S. R.

note of the transmitter must be improved and the wave must be something shorter on the order of 20-30 meters. Finally the mercury arc rectifier must be changed for a valve rectifier.

The channel between Nijni-Novgorod and Tashkent (the latter in Turkestan) has very heavy traffic and an investigation

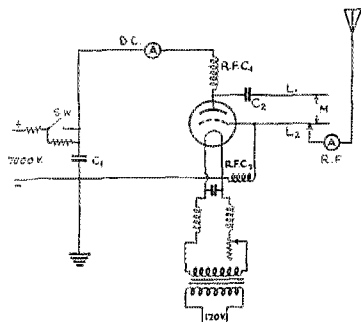
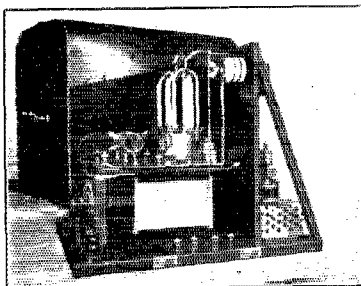

FIG. 2. THE SECOND NIJNI-NOVGOROD TRANSMITTER USED IN TESTS TO TASHKENT

The oscillating circuit is of the ultraudion variety and consists of the tube capacity together with the inductance of two parallel rods L1 and L2 which are connected by the adjustable tuning bridge M. This gave a tuning range from 20.3 to 33 meters. The antenna is voltage fed from a point adjustable along the inductance L2. This transmitter was used with the antenna shown in Fig. 3 and a wide variety of other antennas as explained in the text.

of the short-wave communication between these points became necessary. Therefore from July 20th to the 23rd of September, 1925, a second series of research work was carried out.

The transmitter was hurriedly assembled, not with a separate oscillator, but



B. PORTABLE TRANSMITTER 100 WATTS RATING FED BY 1000 CYCLE A. C.

Transmitters of this type were furnished to an expedition going to Aldan and one was installed at Nezametny.

using only one copper tube. Fig. 2 shows that the oscillating circuit consists of the internal capacity (plate-grid) and the inductance of two parallel copper rods with

a bridge for tuning. The wavelength range was 20.3-33 meters. Several aeriels were tested: (A), vertical wire 2.5 mm. diameter and (A₁) 100 meters, (A₂) 25.6 meters, and (A₃) 5.1 meters high; (B), 3 stranded wires 140 meters long—aerial of a broadcast station—, (C), An aerial with upper radiation.

Fig. 3 shows antenna C. The feeder consists of 2 Lecher wires, an odd number of the quarter wavelengths high and one wire projects $\frac{1}{2}$ -wavelength higher than the other. This projecting portion serves as a radiator.

It was noted that 20-meter signals were heard better during the day than night, 25 meters equally well during the day and night and 30 meters better during the night time. The strength of QRN diminished with shorter waves. Higher aeriels proved

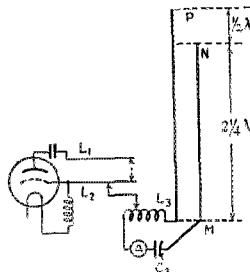

FIG. 3. ONE TYPE OF ANTENNA USED WITH THE OSCILLATOR OF FIG. 2

This is of the type familiarly known as Zeppelin. The 2 Lecher wires N and P together with the inductance L3 and the condensers C3 make up a tuned system which is voltage fed by the jumper between L2 and L3. Since the parallel part of the Lecher system M-N is $2\frac{1}{4}$ wavelengths long and the projecting part N-P is one-half wavelength long we have a standing half wave on the projecting part. This type seems very desirable.

better than lower, e.g., the aerial A₃ (5.1 meters high) was the worst. The vertical aerial A₁ (100 meters high) and the broadcast horizontal (140 meters long) were identical, and the antenna C with upper radiation was decidedly the best.

After this, some experiments were made to establish contacts between Nijni-Novgorod, Tomsk, Irkutsk (Siberia) and Tashkent (Central Asia). The photo B shows a 150-watt transmitter for an expedition to Aldan. One of this type was also installed at the gold field Nezametny.

In October, 1925, all primary arrangements of "radio field" (simply an S. W. station near Nijni-Novgorod) were at the end and a third series of investigations was begun.

Two transmitters were installed for the waves 23 and 40 meters using the circuit

as shown in Fig. 4. Each transmitter consisted of a symmetrical oscillator with two 500-watt tubes (type G.O.) and of an amplifier with two tubes of the same type. The power of the oscillator is a little more than necessary; this is to make the wave more stable. Keying is done by detuning the primary circuit. To facilitate the reception of the emitted signals to broaden tuning somewhat and to smooth out the

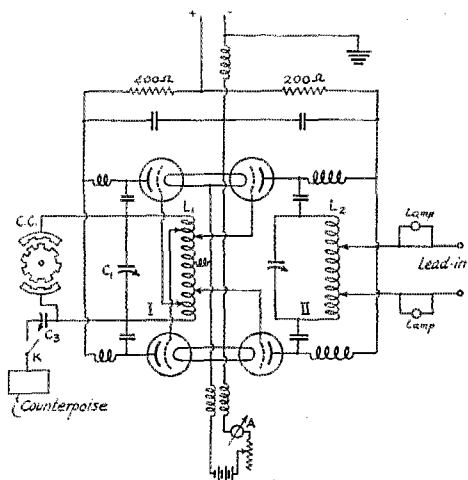

FIG. 4. A LATER TRANSMITTER INSTALLED IN DUPLICATE AT NIJNI-NOVGOROD FOR SERVICE TO TASHKENT ON 23 AND 40 METERS

As before, 2 type G.O. 500-watt oscillators are used in a symmetrical Hartley circuit but in this case the frequency is very slightly "wobbled" at a high audio rate by the capacity choppers CC shunted across the tuning inductance L1. The amplifier in this case is also of the push-pull variety, uses two type G.O. tubes, and its output is directly coupled to one of several types of antennas shown in the following.

possible changes of the wave, a frequency "variator" is employed. It consists of a cogged wheel rotating between two stationary plates, see photo C and Fig. 4.

The antenna is coupled directly to the intermediate (tuned plate) circuit excited by the amplifier. Photo C shows the general view of the transmitter. The base of the transmitter does not touch the floor but is supported by iron tubes driven down directly into the ground. The construction of such a primitive "private base" for the transmitter is quite necessary for gaining stability. In the photograph the frequency "variator" is seen in the foreground. The tubes are air-cooled by means of a ventilator. Ordinary incandescent bulbs are inserted in the antenna lead-in as current indicators.

For the 23-meter wave a directional phased antenna is generally used. It con-

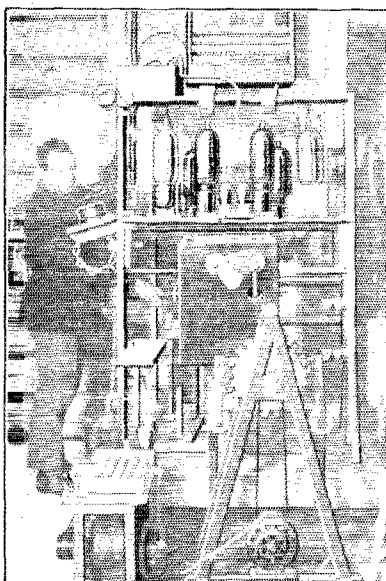

C. ONE OF THE TWO TRANSMITTERS INSTALLED IN DUPLICATE AT "RADIO FIELD", NIJNI-NOVGOROD FOR 23-AND-40-METER SERVICE TO TASHKENT

The diagram is shown in Fig. 4. Prominent in the foreground is the capacity chopper.

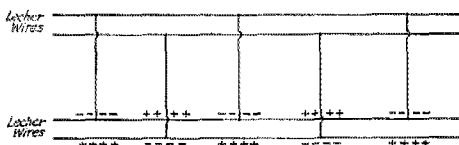
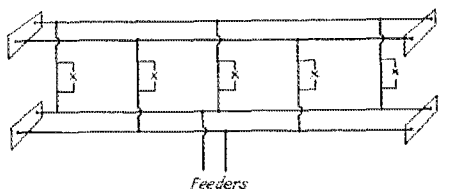

Auxiliary diagram for Fig 5 showing that lower ends of all antennas are at an instant at same voltage, therefore in phase.

FIG. 5. THE "SYNPHASE" ANTENNA USED WITH THE TRANSMITTER OF FIG. 4 AT 23 METERS

The vertical parts are each $\frac{1}{2}$ wavelength or 11.5 meters long and are fed from the Lecher wires which in turn are fed through a single pair of feeders from the station. The system is so phased that it radiates "broadside" that is to say toward or from the reader as he looks at the page. It is made unidirectional by putting behind it a similar system (without feeders) to act as a reflector and the resulting beam is inclined 5° upward by leaning the whole system backward by that angle.

sists of 5 vertical wires each $\frac{1}{2}$ λ long=11.5 meters. Such an antenna is shown in Fig. 5. The radiating system is here connected to two systems of Lecher wires in the

absence of feeders. On this wave an alternate-phase antenna of 8 vertical wires has been tried also. It is shown in Fig. 6. At the same time the antenna with upper

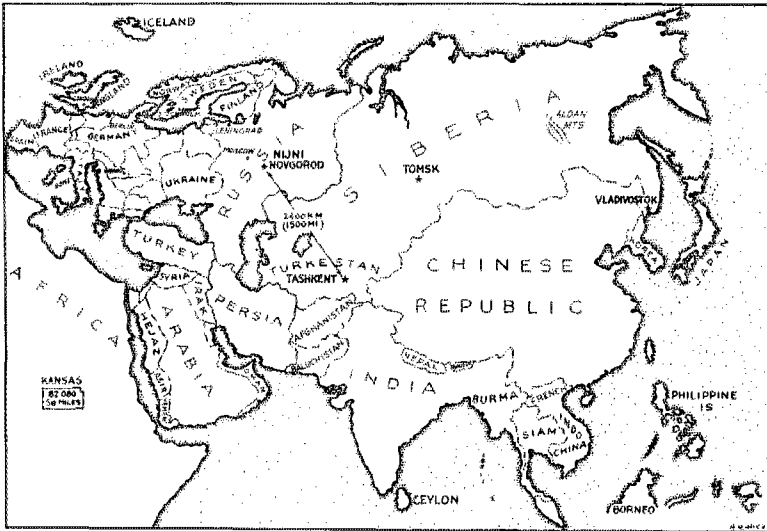

MAP SHOWING THE REGION WORKED OVER

potential nodes.¹ From the middle point of the lower system 2 feeder wires are carried down to the station as shown in Fig.

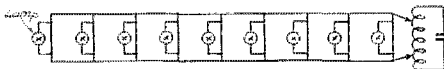

FIG. 6. ANOTHER ANTENNA SYSTEM USED WITH THE TRANSMITTER OF FIG. 4 AT 23 METERS

In this case 8 vertical wires are used, each wire operating in phase opposition to its neighbor.

5. The plane of the antenna is at 5° angle to the vertical line (Zenith) so that the main beam has an elevation above the horizon of 5°. The system is used with a reflector which is exactly similar except for the

1. It seems that antinodes may have been meant, but it is not vital. In either case the system operates with all wires in the same phase. This can be understood by considering that the vertical wires are spaced $\frac{1}{2}$ wave apart which would cause them to operate in phase opposition if fed from a common "standing-wave" feeder, but there are two feeders which are in phase opposition (any normal Lecher or Zeppelin feeder) and the antennas are tapped alternately from the two, which again puts them in phase. This can best be seen from the diagram herewith. The result is therefore a system that operates in the same manner as the system of Fig. 23, page 24, March, QST.—Tech. Ed.

radiation as before mentioned (See Fig. 2) has been tried out.

The comparison of these 3 antennas has shown that the best is the synphase antenna (Fig. 5) (R8-9). Noticeably worse is alternate phase antenna (Fig. 6) (R6-7 and little fading) while the worst antenna is the one of Fig. 3 with upper radiation (R5-6 pronounced fading-effect). The result is that the "synphase" antenna (Fig. 5) gave the best audibility and the smallest fading effect and also has very sharp directional properties.

It is interesting that when the antenna was worked while turned 8 degrees to the south from the steepest portion of the curve of radiation (which is normally pointing out to Tashkent) the fading effect became decidedly noticeable in the morning and evening.

The fading-effect that comes out during the work of antennas of alternate phase (Fig. 6) and upper radiation (Fig. 3) may be explained by the fact that these antennas give less power than the synphase one and fading-effect becomes more pronounced with less power.

For the work on 40 meters another sort of antenna with upper radiation is used.

It is shown in Fig 7. It consists of cage, $\frac{1}{2}$ wavelength long and one meter in diameter. The lead-in wire is $2\frac{1}{2}$ mm. in

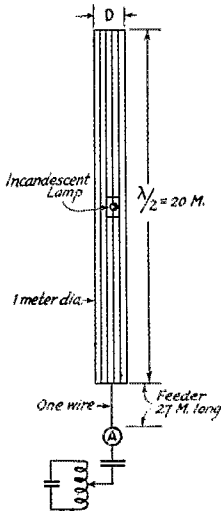

FIG. 7. THE 40-METER VERTICAL ANTENNA USED WITH THE TRANSMITTER OF FIG. 4.

Radiation is chiefly from the upper half wave portion as is explained in the text, the lower portion serving mainly as a feeder.

diameter. The exclusive radiation from the upper part (cage) of the antenna is

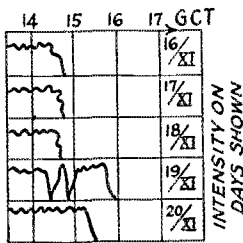

FIG. 8. FADING OUT OF SIGNALS IN TASHKENT IN NOV. 1925 AT A WAVELENGTH OF 23 METERS

Sunset in Tashkent at 12:00 G. C. T. Sunset in Nijni-Novgorod at 13:00 G. C. T.

due to the current in the node of cage being larger than in the lead-in according to ratio $\frac{C_1}{C_2}$ where C_1 is the capacity of cage in a unit of length and C_2 is that of lead-in. In this case $\frac{C_1}{C_2} = 3$.

Such a type of upper radiation antenna gives results equal to the type previously described and yet the wave is smoother and steadier. Such antennas are simple in construction, give excellent results and are greatly used by amateurs.

The main objective in conducting these experiments was to clear up the best suit-

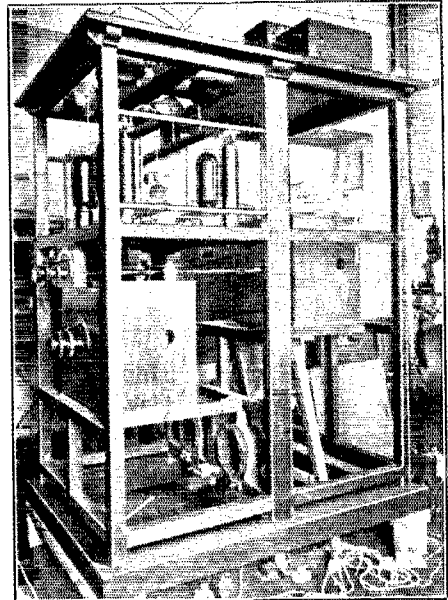

D. THE TRANSMITTER FOR TASHKENT BEFORE INSTALLATION

It is of the same general type as the two at Nijni-Novgorod but of a later and more advanced form.

able time for the work on 23 and 40 meters. The experiments allowed to conclude that signals on 23 meters are heard better dur-

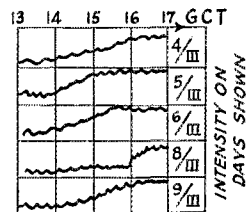

FIG. 9. REAPPEARANCE OF SIGNALS IN TASHKENT IN MARCH, 1926, AT 40 METERS

Sunset in Tashkent 13.10 G. C. T. Sunset in Nijni-Novgorod 14.5 G. C. T.

ing the day and on 40 meters during the night.

Curves in Fig. 8 and Fig. 9 show characteristic examples. The signal sometimes

fades out entirely, but frequently the audibility is changed more or less.

Diagrams in Fig. 10 and 11 allow one to compare the periods of audibility cor-

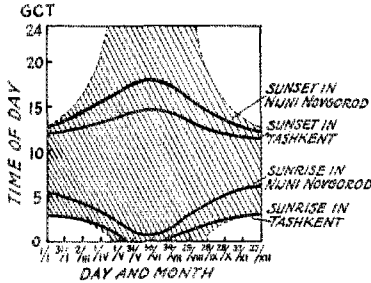

FIG. 10. DIAGRAM SHOWING THE AUDIBILITY OF 23 METER SIGNALS IN TASHKENT. THE SHADED PORTION SHOWS GOOD AUDIBILITY

responding to the sunset and sunrise in Nijni-Novgorod and Tashkent. The shaded areas show good audibility. The diagrams show that periods of appearing and fading out of signals are retarded with respect to

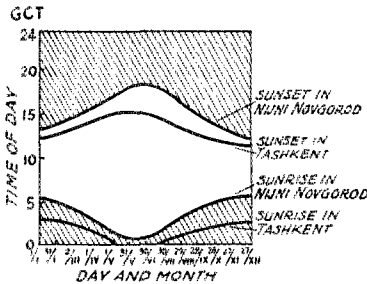

FIG. 11. DIAGRAM SHOWING THE AUDIBILITY OF THE 40-METER SIGNAL IN TASHKENT

The shaded portions show good audibility. Note that the two diagrams overlap, in other words one or both wavelengths work at all times.

sunset and sunrise. It is clear that waves of 23 and 40 meters lap over each other and that 24-hour contact between Nijni-Novgorod and Tashkent is possible. It must be noted that the time of appearing and fading out of signals does not change regularly from day to day but changes irregularly. Perhaps this is due to some meteorological disturbances. Nevertheless when one wave fades out we have good enough audibility on the other. Covering would be better without doubt if more waves in the same band could be used.

This series of experiments gave as practical results improvement of our short-

wave transmitters, and of the emitted wave (which is now steady, well modulated and easy to take and to speed up). Directional work gave further improvement. A practical rule for working over the 2400 km. distance with waves of 23 and 40 meters during different times of the day and night was also found.

At the present time the experiments are being continued with the objective of clearing up the possibility of short-wave communication between Nijni-Novgorod and Siberia and the Far East (Vladivostok) and Central Asia.

A.R.R.L. Technical Information Service Rules

Please help us by observing the following rules:

1. Keep a copy of your questions and diagrams and mention that you did so.
2. Number the questions and make a paragraph of each one.
3. Make diagrams on separate sheets and fasten them to the letter.
4. Print your name and address (not merely your radio call) on your letter. Don't depend on the return address on the envelope as this is destroyed when the letter is opened.
5. Don't ask for a comparison of the various manufacturers' products.
6. Before writing, search your files of *QST*—the answer probably is there.
7. Address all questions to Information Service, American Radio Relay League, Inc., 1711 Park Street, Hartford, Conn.
8. It is not essential to enclose an envelope as long as you supply postage and **PRINT CLEARLY** your name and address on your letter.

Standard Frequency Transmission from 9XL

STATION 9XL is a special station, comprising one of the three portions of the "Gold Medal Station", WCCO-9XL-9WI at Anoka, Minnesota. WCCO operates as broadcast station, 9XL purely as a standard frequency station and 9WI as a general amateur station, the three transmitters having independent equipment and antennas but a common power supply. Through arrangements made by K.V.B. Lansingh of the Official Wave Length Station Committee of the Experimenters' Section, A.R.R.L. 9XL is operated on schedules regularly announced in *QST*. The work of

(Concluded on Page 32)

Low-Power, Flexible Crystal-Control for Four Amateur Bands

By S. P. McMinn*

WITH the narrowing of the amateur bands, and the probable increase in population density which likely will result within them; the importance of crystal control greatly increases, not only must we crowd a greater number of stations within the confines of each so-called band, but we must do so without increasing QRM either to other transmitting amateurs or to our army of BCL friends.

The expense of crystal control has been the chief reason it has not been more widely adopted, for the benefits of its bell-like signal, its sharpness of tuning, its positive and unfailing location in one and *only one* spot on receiving operator's dials are recommendation enough for its universal use.

Now that crystals generally are more reasonable in cost (according to friend Watts they aren't at all difficult to prepare in the home laboratory) additional interest attaches to the physical means of using them.

And that, in brief, is reason for this description of a crystal-controlled trans-

mitter that, if not the *acme* of simplicity, at least approaches it; that is so exceedingly flexible that it is possible to QSY in to

two places in each of the four amateur bands—20, 40, 80 and 160—that requires the minimum of junk, the least possible space in the shack and that is a first-rate, all around means of communication, excellent for local work and with distinct DX possibilities.

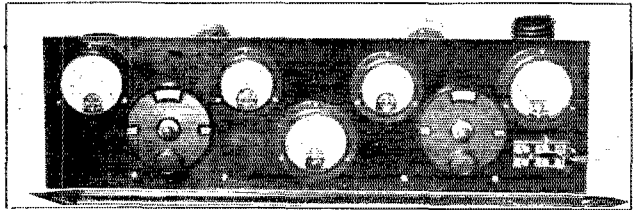

FRONT VIEW OF THE COMPLETE 20-TO-160-METER TRANSMITTER

From left to right the meters are: crystal tube tank-circuit ammeter (0-3); crystal tube plate-current milliammeter (0-100); a.c. filament voltmeter for all tubes (0-15); amplifier plate current milliammeter (0-500). The D. P. D. T. switch is for changing the two amplifier tubes from d.c. (parallel) to a.c. (back-to-back self-rectified) operation.

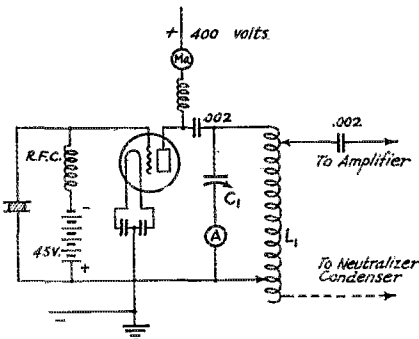

FIG. 1 THE OSCILLATOR CONNECTIONS

The filament supply is omitted for simplicity and can be found on the general diagram, Fig. 5. C₁-L₁ is the "tank" or tuned-plate circuit which can be seen at the left in the rear view of the set.

mitter that, if not the *acme* of simplicity, at least approaches it; that is so exceedingly flexible that it is possible to QSY in to

Having pioneered crystal control work, I have about come to the definite conclusion that there is no particular advantage in high power. Repeated tests with inputs ranging from 25 to 200 watts have failed to reveal any startling difference in the signal strength reported by other stations. How much of this is due to the use of crystal control it is hard to state, but no doubt it is the crystal-clear, unwavering note that carries through atmosphere, QRN and QRM.

Hence, this newest transmitter of mine is built around a trio of 210 tubes. One is used as the oscillator and the other two as an r.f. amplifier. The beauty of the rig is that it can all be constructed of such receiving junk as may be around the shack. The condensers are ordinary receiving Cardwells, the chokes are receiving type and the plate blocking and coupling condensers are receiving type Sangamos.

So far, the rig is entirely orthodox and not at all startling. However, a degree of flexibility has been obtained that is altogether out of the ordinary.

In the first place, the crystals, four of 'em, are in plug-in mountings and thus are rapidly changed. Next, the inductances

*2WC, also Editor, Automotive Merchandising, 97-103 Horatio St., New York City, N. Y.

also are plug-in. And finally, the two tubes in the amplifier are so arranged with a double-pole double-throw switch that they may be worked either back-to-back, self-rectified, or in parallel with d.c. supply. When anyone says "QSS" I shift to RAC by flipping a switch, or use the buzzer modulation. If they say "QRM" I put in another crystal, swing the oscillator and

measures 24 x 10 inches. The whole transmitter fits nicely in a 7" x 24" x 10" standard cabinet.

CONSTRUCTION

Although the wiring diagrams tell about all that is necessary to know about the set, a few notes will help in building it. The inductances are wound of No. 12 bare wire on forms that once held Cardwell radio frequency chokes. They are 2 inches in diameter and were used chiefly because the form was handy and already equipped with plug-in jack tips.

The crystals are in circular Bakelite holders which are completely enclosed to exclude dirt and moisture. They never need be touched. The mounts are fitted with knife-blade type contacts which fit nicely into those parts from a small knife switch that the blade normally fits. It makes a very nice, tight, easily separable mounting.

The wiring was first done on paper, by putting all the apparatus on a sheet the size of the baseboard and drawing in the wires with pencil. After the various parts had been shifted about a bit the best arrangement for short leads, reduction of possible feed-back effects, and safety, was easily found. Then the wiring was done with No.

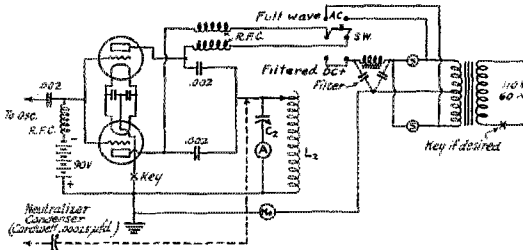

FIG. 2 THE AMPLIFIER DIAGRAM SIMPLIFIED BY OMISSION OF FILAMENT SUPPLY

The main thing to be noted is that with switch Sw. down the tubes operate in parallel with rectified-and-filtered supply but with the switch up the two tubes operate back-to-back on a.c. supply. S-S are the three-year old tube rectifiers. Cheer up—we will have something of the sort again soon.)

amplifier tuning condensers a few notches, retune the antenna and GA. Nothing to it. Furthermore, it is a very simple matter

| Crystal and Oscillator Wavelength | | Antenna Radiating Wavelength | Antenna tuned to (Harmonics in Parenthesis) |
|-----------------------------------|-------------------------------|------------------------------|---|
| 160 | amplify straight through | 160 | 160 with ground |
| 84.15 | amplify straight through | 84.15 | 84.15 with C. P. |
| 77.8 | amplify straight through | 77.8 | 77.8 with C. P. |
| * 40.0 | amplify straight through | 40.0 | 80.0 with C. P. (2nd) 120 with C. P. or ground (3rd). |
| 84.15 | double frequency in amplifier | 42.07 | 84.15 with C. P. (2nd) or 126.2 (3rd) with ground. |
| 77.8 | double frequency in amplifier | 38.9 | 77.8 with C. P. (2nd) or 106.7 with either C. P. or ground (3rd). |
| † 84.15 | quadruple in amplifier | 21.04 | 84.15 with C. P. (4th). |
| † 77.8 | quadruple in amplifier | 19.45 | 105.2 with C. P. or ground (5th). |
| * 40.00 | double in amplifier | 20.00 | 77.80 with C. P. (4th) 97.25 with C. P. or ground. 80.00 with C. P. (4th). 100.00 with C. P. or ground (5th). |

FIG. 3 CHART TO SHOW METHOD OF AMPLIFICATION FOR THE 9 DIFFERENT WAVELENGTHS—ALL CRYSTAL CONTROLLED AND ALL WITH THE SAME ANTENNA

to put Heising modulation on the amplifier and use phone, of which more later.

The whole rig is built behind a 7" x 24" bakelite panel which holds all the meters, the tuning condensers and the switch for changing from r.a.c. to d.c. on the amplifier. The compactness of the affair may be judged by the fact that the baseboard

12 enamelled stuff which is easy to work but stiff enough to stay put.

THE CRYSTALS

There are two crystals in the 80-meter band, one oscillating at 77.8 and the other at 84.15; there is one in the 40-meter band; and one in the 150-190 band. Thus, either

of the 80-meter crystals can be used in that band and also in the 40-meter band by doubling frequency; by quadrupling frequency, the 80-meter crystals also furnish harmonics for the PA to amplify in the 20-meter band. The 40-meter crystal can also have its frequency doubled in the 20-meter band and gives better output at 20 than do the 80-meter crystals. The 160-meter crystal works in its own band, of course, and also in the 80-meter band by

It is therefore much better to use the 40-meter crystal * or to wire in an intermediate amplifier and double frequency twice. This is not so tricky because it does away with the need for neutralizing and gives better output.

There is nothing tricky about using a 40-meter crystal except that it is wise to reduce the plate voltage a bit, say to 300, and to be very careful that the circuits are properly neutralized if amplifying at

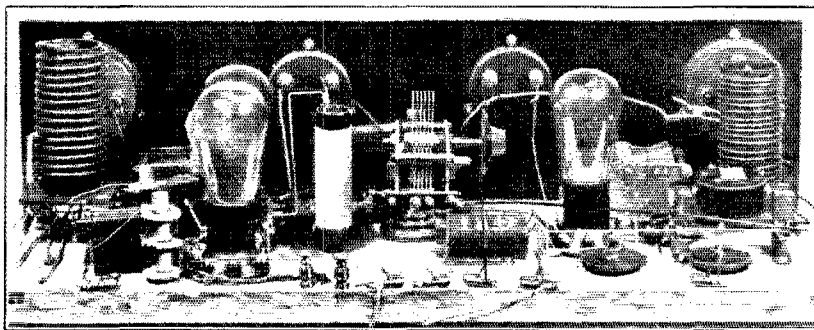

FROM THE BACK THE SET LOOKS LIKE THIS

Reading from left to right we have first the amplifier inductance and two amplifier tubes with their associated plate stopping condensers r.f. chokes, next the amplifier grid choke coil and in the center the neutralizing condenser with the fixed oscillator-amplifier coupling condenser back of it and the oscillator filament by-pass condenser in front of it. After that comes the oscillator tube, in front of which are the pancake grid and plate r.f. chokes while partly concealed behind the tube is the oscillator grid-plate-circuit tuning condenser. Finally, at the right is the oscillator inductance and in front of it one of the crystals in its bakelite mountings. The whole thing is built on a 24" x 10" baseboard behind a 24" x 7" panel.

doubling its frequency in the r.f. amplifier. No attempt has been made to use the 160-meter crystal in the 20-meter band because the output undoubtedly would be exceedingly small; besides, there is no need to do so. All of this is further explained by Fig. 3.

THE EXTRA 40-METER CRYSTAL

In the list above and in Fig. 3 (see the *) there will be noticed a 40-meter crystal. This is *not* strictly necessary. It is perfectly practical to quadruple frequency from 77.8 and 84.15 to 19.45 and 21.04 as shown at † in Fig. 3. This is regularly done at 2WC, especially since at 20 meters small power seems to go about as well as big power.

If you want corroboration of the fact that you *can* quadruple frequency in 1 stage, refer to that article by Glaser in June, 1927, *QST*. However, the efficiency by that method is low and it is an expediency rather than a good way to do the job. This is so because the output when quadrupling from 80 to 20 is very small.

the same frequency. A 40-meter crystal is a very fragile animal and a surge or kick back that makes the thing vibrate too strongly is likely to cause edge chips. Too high voltage may puncture the thing and make it worthless. It is important, with any crystal for that matter, to use a *very* light top plate, a vertible featherweight. A thin dime smoothed perfectly flat is excellent. If a heavier top plate is used it imposes a physical burden on the crystal which must lift and lower the plate with each vibration and they vibrate darn fast! The result is that operation becomes unstable, the crystal is hard to start and heating results from the work the crystal must do. It is better, too, to use a top plate that leaves a generous margin of crystal all around it. This will prevent brushing between the top and bottom plates at the edges. It is not necessary ever to have the top plate completely cover the crystal, contrary to popular conception. Another popular misconception is that you have to strive by might and main not to have any more capacity in shunt with the

crystal than is absolutely necessary. Refer again to Glaser's article in which is described the use of three crystals in parallel with a switching arrangement to use either. Thus he has tripled the capacity

denser large enough to reduce the fundamental for 80-meter operation; for 20 and 40, it is operated on harmonics. For 160 meters the antenna and counterpoise are tied together and worked against a water-pipe ground.

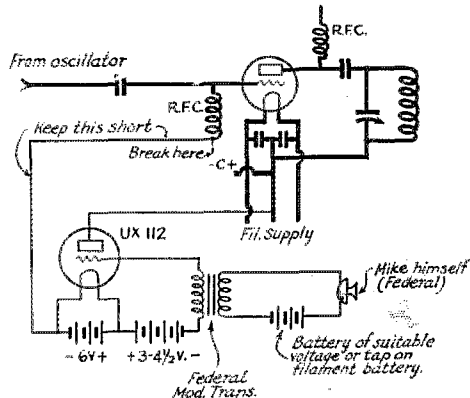

FIG. 4. DIAGRAM OF ONE OF THE MODULATOR SYSTEMS

This one uses a UX-112 as a leak on the amplifier tube. The heavy wires are normal set wires and the light wires are added as part of the modulator. The lead from the r.f.c. to the filament of the 112 must not be over 2 feet long. Try to find a truthful listener and increase the grid bias of the 112 until the voice starts to become fuzzy. If any of the batteries on the 112 are grounded trouble may follow. 4 dry cells are therefore recommended, likewise a separate C battery, though the mike may work on the 112 filament battery if the latter be not grounded. Things are simplified if the mike cord has a plug to operate a filament-control jack for the 112.

With a little more complication Heising modulation of the amplifier may be used. In this case the 112 becomes an audio amplifier, feeding a pair of 210 modulators thru a resistance-capacity-impedance coupling, which permits the same plate supply to operate the 112 and the amplifier-modulator combination.

The simple system shown here has the advantage for several reasons.

in shunt without disastrous or untoward results.

As a general rule, the lower the frequency of the crystal, within limits, the higher the plate voltage may be with safety. Thus you can use 550 to 600 on a 160-meter crystal, but 400 is safe on an 80. Over at the Bell Labs. in Whippany they are using 750 v. on a 500-meter crystal through a 211-D tube, with safety. Of course the crystal is in a mounting that keeps its temperature constant, but this is unnecessary for amateur work.

THE ANTENNA

The antenna has a calculated fundamental of about 120 meters and consists of a single No. 12 enamelled sky-wire 100 feet long and a single-wire counterpoise 75 feet long. It is tuned with a single con-

THE POWER SUPPLY

It is hardly possible to use the same plate power transformer for both oscillator and amplifier because of the poor regulation of transformer and rectifier combinations. In other words, with the key down a single transformer rectifier that would give 550 volts on the amplifier and not over 400 on the oscillator would produce well over 600 with the key up and this might easily endanger the crystal, to say nothing of putting an unnecessary strain on blocking and filter condensers. The power supply consists of a Thordarson R210 Power Compact for the oscillator. This furnishes filament current for the 216B rectifying tube without the need for a filament rheostat. It also supplies exactly the proper voltage for the crystal tube.

The Thor 210 Power Compact uses a special transformer developed to furnish "B" power for an ordinary receiver and also 400 volts for a 210 amplifier. It also has two filament windings, one giving 75 volts without external center tap (which serves to heat the filament of the 216B type rectifier tube) and the other giving 7 1/2 volts with center tap. This second filament winding is not used because the transformer has not sufficient capacity to heat the filaments of all three 210 tubes in the transmitter. The 400-volt winding gives about 500 volts on no load through a filter consisting of two mikes ahead of a 30-henry B-eliminator type choke and two mikes behind it. Under 40-mil load the output voltage is slightly over 400, and therefore is exactly right for crystal operation.

On the amplifier a Thordarson T-2098 furnishes plate power which is run through a Thordarson T-2099 choke (two 30-henry chokes in series) with two mikes of condenser on each side of it. The 2098 also supplies the filament current for the 281 rectifying tubes. The filaments of the 210's are all in parallel and fed by a separate transformer. The rectifier for the amplifier plate supply is a pair of 3-year old "S" tubes.

The reason for arranging the amplifier for the use of either a.c. (which, of course, becomes r.a.c.) or d.c. is because the a.c. is a bit broader, though not enough so to be objectionable to other nearby amateurs.

Some operators complain, justly or unjustly, of excessive fading when using pure d.c. on the amplifier. In such cases it is

sometimes helpful to be able to shift to a.c., which, with the singing, bell-like d.c. oscillator behind it has a peculiar and quite distinctive note that is pleasing to the ear and easy to copy. Also, the a.c. is often of assistance in raising stations that might pass over the razor sharp pure d.c. crystal note.

The only draw-back to using two tubes in the amplifier is that it is almost impossible to get a perfectly pure d.c. note. There is always present a slight ripple about 5 per cent, I should say, though everyone reports the thing pure d.c. Still it is not as perfectly pure as when using a single tube in the PA. I don't know why this is, but it probably is not important. Anyway, a little ripple helps make the tone less monotonous! !

GETTING INTO OPERATION

This little baby rig is about the easiest thing imaginable to get going and properly tuned up. You first get the oscillator going and tuned for maximum tank current with minimum mils. Put about 400 volts, rectified and well filtered a.c. on the oscillator. The tank current should be about three amperes, using an 80-meter crystal, and the plate current of the oscillator should be around 40.

Then with the filaments of the amplifier tubes lighted, *but the plate power left off*, vary the amplifier tuning condenser until you get quite a bit of current in that tank. If you don't get any, the chances are the thing is by lucky chance nearly neutralized, but generally you will get quite a lot.

When working 'straight through' with any of the crystals it will be necessary to neutralize to prevent feed-back from the amplifier to the oscillator and to permit the amplifier to be tuned properly to the oscillator frequency. When doubling, the neutralizer may be left on, or cut out with a switch, as desired. When quadrupling, the added capacity of the neutralizing condenser is too great and the neutralizer must be cut out of the circuit.

Then vary the neutralizing condenser and the amplifier tuning condenser until you reach an adjustment of both which gives practically no current at all in the amplifier tank and no appreciable movement of the oscillator plate milliammeter when the amplifier tuning condenser is passed through the resonance point.

The adjustment of the neutralizing condenser is quite critical, but don't get discouraged. It is entirely possible to neutralize the amplifier properly and it won't work right until you do. Move that neutralizing condenser only a hair at a time!

When neutralization has been effected, hit the key and see what happens, using low voltage on the amplifier tubes, of

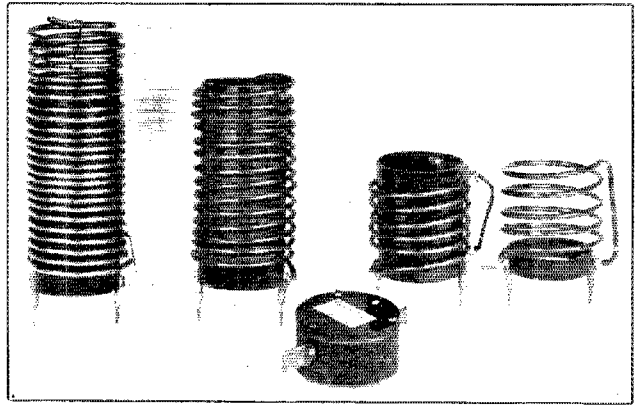

THE TUNING INDUCTANCES OF THE SET, ALL WOUND WITH NO. 8 BARE COPPER WIRE ON CARDWELL R.F. CHOKE FORMS, 1 $\frac{1}{4}$ " IN DIAMETER

Left to right the coils are, 25 turns used at 160 M. when shunted by a .001- μ fd condenser, 14 turns, used at 80 meters with 3 end turns left over for neutralizing, 5 $\frac{1}{2}$ turns used at 40 meters, and 4 turns used at 20 meters. All but the 160-meter coil operate with no capacity beyond that of the .0005- μ fd variable condenser.

A crystal holder is shown in the foreground to illustrate the plug-in feature.

course. Hold the key down and tune the amplifier tank for maximum current as indicated on the ammeter.

Next couple the antenna, re-tune the amplifier tank and tune the antenna to resonance. The coupling is fairly critical and will take a bit of experimenting. Every time you change the coupling you must re-tune both the antenna and the amplifier tank. When the coupling is right you will get maximum antenna current with minimum amplifier tank current—showing that the antenna is soaking up nearly all the current generated in the amplifier tank.

High amplifier tank current indicates insufficient coupling, or an antenna that will not properly tune to the working wave of the amplifier. You may have to load your antenna by using a coupling coil with a greater number of turns in it.

CONCERNING THE COILS

Now, as to L. When using the 80-meter inductances, you merely shunt them with a Sangamo fixed receiving condenser of

.0015 or .002, which boosts the QRH of the combination to 160 or thereabouts, final adjustment being made with the variable condenser. The 80-meter inductances have 14 turns in the oscillator; leaving three for the *below ground* neutralizing condenser connection. And the PA inductances have 11 turns of a little heavier wire a little widely spaced. The 40-meter inductances have 7 and 5 turns, respectively; and the

be found that even a small filter on the power amplifier is adequate because of the refining effect of the crystal-controlled energy that is fed to the grids of the power amplifier.

In conclusion it is only fair to give credit to Scientific Radio Service of Mount Rainier for their excellent co-operation in assisting in the design of the rig and for supplying the crystals and mounts around

which it is built and which are so important in its proper operation. Crystals that are fussy, or tricky, or at all uncertain in starting oscillation and in keeping right at it indefinitely, are an abomination. Good ones are a joy to work with and are easily responsible for the elimination of about 80 per cent of the troubles that might be blamed on other things.

Straits

An interesting method for controlling regeneration is suggested by 1AQD. It consists of using our old friend, the absorption loop. He uses a turn or two of wire coupled to the secondary coil of the tuner. A carbon pile rheostat is connected across the coil and as its resistance is varied, the amount of energy absorbed from the tuning circuit is likewise varied. One side of the circuit is grounded to reduce hand capacity effects. He states that it is necessary to use a compression type rheostat as a wire wound affair would be noisy in operation.

Woolworth V & X stores are offering another boon to amateurs in the form of straight glass cylinders which may be purchased at X cents each. They are normally used as the middle section of a hydrometer, are open at both ends and have a uniform diameter of approximately 7/8-inches throughout their entire length of six and a half inches. By sticking a cork in each end and fastening them to suitable supports, a first rate mounting for an r. f. choke will be had. Corks for the job may also be obtained at the same store for V cents a dozen.—6DCA.

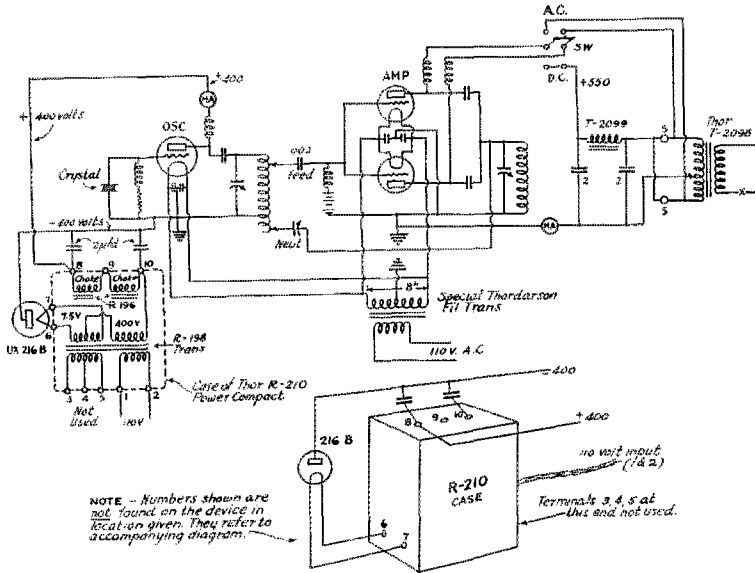

FIG 5
THE GENERAL DIAGRAM

20 which is only needed in the PA has 3-4 turns. All inductances are 2" in diameter.

AS TO PHONE

There are several ways to use phone on the set. Perhaps the easiest, (though a low percentage of modulation is obtained) is to put the secondary of a modulation transformer in series with the C bat on the oscillator. The primary of the modulation transformer is in series with the usual 6V. battery and mike. Substituting a buzzer for the mike gives a beautiful 500-cycle tone that is very attractive and not at all broad. This is the scheme that was described by Ed. Glaser of 2BRB in QST for June, 1927.

It is comparatively simple, of course, to throw together a Heising modulation circuit and feed the plate power for the amplifier through that instead of direct to the plates of the amplifier tubes. This gives a high percentage of modulation and very good quality. Whatever modulation system is used it will

The A.R.R.L. Board Meets

THE Board of Directors of the American Radio Relay League was in regular annual session throughout the 17th and 18th of February, at Hartford. Every Director was present, every section of the country represented. The affairs of the League were examined in detail, the Headquarters properties inspected, and policies outlined and instructions given the officers for the coming year.

Mr. Maxim and Mr. Stewart were unanimously re-elected as President and Vice President for the coming year.

The Board received the annual reports of the League's five officers; ratified the acts of the Executive Committee in the past year; voted to meet hereafter in May instead of February; examined League finances; commended the Headquarters Staff on its handling of the business af-

technical difficulties of operating under the new convention, a most important action on which we shall have considerable to say in *QST* soon; voted to request the restoration of the Extra First Class Amateur Operator's license; discussed at length the question of wave-bands for amateur phone and adopted new recommendations to the Commission as reported below; considered Division boundaries but made no changes; provided for the investment of the surplus funds of the League; adopted protective policies respecting invasion of amateur bands by non-amateur stations and respecting quiet hours and interference from harmonics, heard a report from Director Segal on his work in combatting anti-amateur municipal ordinances and extended thanks to him for his valuable work, particularly in the matter of the Wilmore decision; reconsidered at length

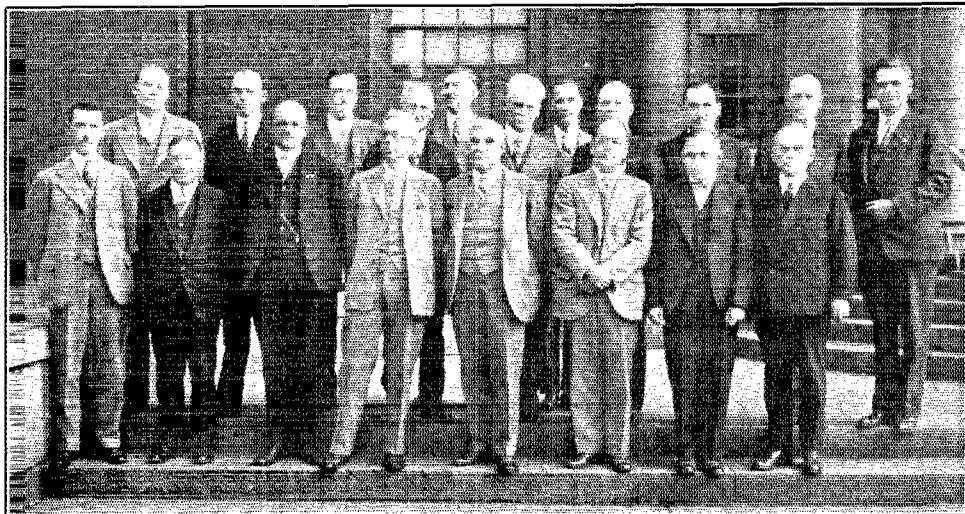

OFFICERS AND DIRECTORS OF THE A.R.R.L. AT THE RECENT ANNUAL MEETING

Left to right, top row: Mr. Weingarten, Northwestern Division; Mr. Painter, Delta; Communications Manager Handy; Vice President Stewart; Canadian General Manager Russell; President Maxim; Mr. Quinby, Midwest Division; Mr. Darr, Central; Dr. Dunn, Hudson; Mr. Dobbs, Southeastern; Mr. Corlett, West Gulf. Bottom row: Secretary Warner; Treasurer Hebert; Prof. Jansky, Dakota Division; Mr. Gravely, Roanoke; Prof. Woodruff, Atlantic; Dr. White, New England; Mr. Segal, Rocky Mountain; Mr. Babcock, Pacific. (Photo courtesy "Hartford Times".)

fairs of the League; made plans for encouraging the beginning operator; outlined plans to further international communication under the restrictions of the new international convention, as is discussed editorially this month; authorized the undertaking of a technical development program to aid members in meeting the

the question of national conventions and reaffirmed the previous decision to abandon them; discussed pending legislation; inspected the new Headquarters Station 1MK and commended the Communications Manager on the job. Detailed reports of conditions in every territory were made by the Directors, the desires of the member-

ship reported, and action taken on matters brought up. The Secretary's minutes of the meeting fill eighteen pages; obviously only the high-lights can be mentioned here.

The question of amateur phone wavelengths was most carefully considered by the Board in several hours' discussion, after a committee of the Board had given a hearing to a representative of phone amateurs who were dissatisfied with the recent change in regulations sponsored by the League. With every Director present and views therefore expressed from every section of the country, the Board unanimously decided to recommend to the Federal Radio Commission that the two upper phone bands be changed to read 1715 to 2000 kilocycles and 3500 to 3550 kilocycles. Some explanation of the thoughts back of these recommendations may be of interest. Let it be said at the outset that the Board took into account the changes in amateur bands provided in the Washington Convention, which are to be expected by the first of next year.

The long-wave band mentioned is from 150 to 175 meters. Although phone at present operates up to 190 meters, the waves above 175 will be assigned to the mobile service after this year. It is undesirable to encourage the establishment of stations on waves above 175 now, only to have the owners forced to change wavelength next year. A more important consideration is QRM to BCLs; the probability of interference by phone operation on waves above 175 meters is so great that such operation seems inadvisable. Most of the phones are below 170 meters now anyway. Therefore the recommendation of 150 to 175 meters.

The 85-meter recommendation embraces 50 kilocycles. The original phone assignment there of 100 kc. was made at a time when the 40-meter band was 1000 kc. wide and carried an enormous percentage of the A. R. R. L. domestic communication. Under the conditions of the immediate future the bands will be so seriously curtailed that reduction in privileges will be suffered by every form of amateur operation. As a single example, the 40-meter telegraphing band becomes 300 kc. for all the world, instead of 1000 kc. for North America alone, and when this is shared with amateurs of other countries the congestion will be so great that 40-meter operation will have to be confined to international and coast-to-coast work. All of the moderate-distance work that has been going on in that band will then have to be accommodated in the 80-meter band. For that reason the Board's recommendation, arrived at after intensive considera-

tion, is for a phone privilege 50 kilocycles in extent.

The Board has recommended that the 20-meter phone privilege be rescinded. The new international band for amateurs at 20 meters is 400 kc. wide. The width of a signalling channel increases, at the present state of the technique, directly with the frequency. That is to say, in terms of the number of stations which can be accommodated the 20-meter band is equal to 200 kc. at 40 meters or to only 100 kc. at 80 meters. Of course the chief utility of the 20-band is for international DX and it is therefore one of the bands which will have to be shared with amateurs of other nations. The League is undertaking to negotiate an informal agreement with the amateur societies of other countries, under which North American amateurs would operate in the top halves of the 20-meter and 40-meter bands. The net effect of this is to say that the territory which will be available for American amateurs at 20-meters after the first of next year is no greater than an expanse of 50 kc. in the 80-meter band. Immediately it becomes apparent that it is a physical impossibility to make provision for phone in the limited band which the international conference has left us and have any assurance of privileges for telegraphy. Looked at another way, imagine that we have, next year, 200 kc. at 20 meters for American amateurs. Reliable engineering figures indicate a minimum commercial channel width at 20 meters of 40 kc., which is to say that our band contains room for but five commercial channels of minimum width. Even if a single one of these channels was made available for phone, it would amount to 20% of the entire territory if every phone in America succeeded in working on exactly the same wavelength, which they would not and could not do, and it would be a privilege utterly valueless to the phones themselves. It was therefore the opinion of the Board that the state of the art does not offer promise of successful and satisfactory work under the conditions now confronting us in the 20-meter band and that, for the present at least, they should recommend rescinding the 20-meter phone privilege.

The Board brought to bear upon this question all of its past experience in planning for the future, its technical talent, and its ability to reflect amateur viewpoints from every part of the country. It is hoped that the membership will be pleased with the decisions and will appreciate the reasons which lie behind each one. The recommendations have now been conveyed to the Federal Radio Commission.

K. B. W.

Notes on the Design of Iron-Core Reactances Which Carry Direct Current

By D. E. Replogle*

This is the third of a series of articles by members of the Raytheon organization on the practical design of filters and filter parts. The first appeared in the September issue and the 2nd in the February issue. The fourth will follow shortly.

These articles are based on the very extensive experience of the Raytheon organization with the problems of manufacturers of "A" and "B" substitutes. It covers the "low-pass" type of filters used in these devices and also in transmitting plate supplies.—Technical Editor.

THE great increase in the use of rectified and filtered plate and filament supplies within the last few years has emphasized the need of adequate design methods for filter reactances. Such chokes carry a comparatively large amount of d.c. with a superposed a.c. ripple, and the design is thus somewhat more difficult than that of an ordinary a.c. reactance.

An excellent contribution on this subject was made by C. R. Hanna¹ who gave design curves for use with Westinghouse 4% silicon steel and for Westinghouse "Hypemik." Since most choke coil manufacturers do not use these steels, however, it was thought worth while to compute similar curves for other commercial sheets. Data were obtained from the manufacturers, and the necessary calculations were made in accordance with Hanna's formulas. For the theory of the method, the reader is referred to the above work by Hanna, a brief synopsis of which appears at the end of this paper, and also to papers by Spooner².

PERMEABILITY CURVES

Permeability curves for a number of steels are given in Fig. 1. They were computed from the manufacturers' saturation curves by use of the relation,

$$\mu = B/H.$$

It will be noted that steels 1 and 2 are very high in permeability, the other materials grouping themselves at a lower level.

INCREMENTAL PERMEABILITY CURVES

Referring to Fig. 2. When direct current having a superposed a.c. component flows in a choke, the flux density rises to a certain point (a) on the saturation curve,

Note: The material for this paper was obtained from the work of P. H. Moon and W. K. Fleming of the Raytheon Laboratories of Cambridge, Massachusetts.

1. A.I.E.E. Jnl., Feb. 1927, p. 128.
2. T. Spooner, Phy. Rev., 1925, p. 527. A.I.E.E. Jnl., Jan. 1923.

*Director Customer's Service Laboratory, Raytheon Mfg. Co., Cambridge, Mass.

this point being determined by the d.c. ampere-turns and by the ordinary permeability (μ). The a.c. component then causes the flux to describe the small



VIEW OF RAYTHEON CIRCUIT LABORATORY IN WHICH WORK DESCRIBED IN THE ACCOMPANYING PAPER WAS CONDUCTED

This shows the set-up employed for determining inductances of an iron core choke under different conditions of d.c. saturation.

hysteresis loop at (a). The permeability to the a.c. component is *not* the permeability (μ) but a smaller value ($\mu\Delta$) which is equal to the slope of the line drawn through the ends of the small hysteresis loop. The permeability ($\mu\Delta$) is called the *incremental permeability*. As H due to d.c. increases, the hysteresis loop moves up on the saturation curve. It will be noted that at high values of B the slope (and therefore the incremental permeability) decreases.

The method of determining ($\mu\Delta$) is given in Spooner's papers and will not be repeated here. The curves of Fig. 3 give the incremental permeability for several grades of steel, and it is evident that ($\mu\Delta$) decreases as H increases as pointed out above. These curves were calculated for a very small a.c. component. When the a.c. component is large, the hysteresis loop increases in size and tilts at a greater angle. Thus the incremental permeability increases somewhat for large values of a.c. Additional curves

for various amounts of ripple could have been plotted, but it was not felt that the greater complexity would be warranted.

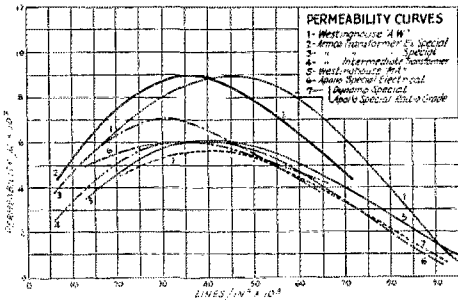

FIG. 1. NORMAL PERMEABILITY CURVES

Also, due to the use of a small value of a.c. component the results obtained will always be on the safe side.

DESIGN CHART

The design chart, Fig. 4, shows the relation between LI^2/V and ampere-turns per inch. Curves are plotted for five grades of steel. The numbers along the curves are the ratios of air-gap to length of magnetic path to give the maximum inductance. Other values of (a/l) can be used, but will not give quite as high inductances.

For a given choke with given current, the inductance is directly proportional to LI^2/V . This means that the higher the curve is on

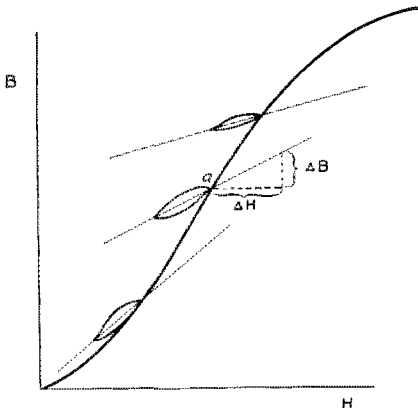

FIG. 2. EXPLANATORY DIAGRAM—INCREMENTAL PERMEABILITY CURVE

this sheet, the more inductance will be obtained in a given size choke. Thus steels 1 and 2 are seen to be better than any of the others. In Figs. 1 and 2 we saw that they had the highest permeabilities, and here we

see that the effectiveness of a choke is greatest if made of these steels.

The difference is not large, however, the maximum difference between numbers 2 and 5 being only about 15%. Therefore, it would seem that for most reactances an ordinary steel of low silicon content would be advisable because of its lower cost and smaller wear on the dies.

PROCEDURE IN DESIGN

The desired inductance L and the direct current I are known.

1. It will now be necessary to assume some size of core. Usually a standard

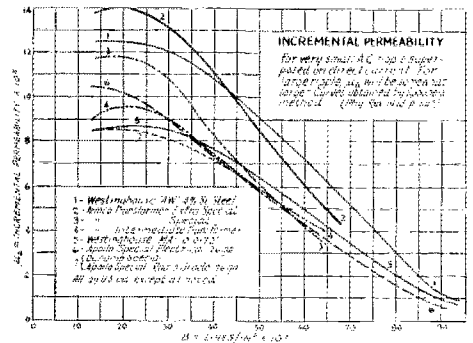

FIG. 3. INCREMENTAL PERMEABILITY CURVES

punching will have been decided upon, in which case it will only be necessary to assume a height d for the stack of laminations. Then determine the cross-sectional area of the core A and the length of magnetic path l . V is the product, or $V = Al$.

2. Compute LI^2/V .
3. From design chart, find the value of NI/l corresponding to the above value of LI^2/V .
4. The total number of turns to be used is then found by dividing the above value of NI/l by I and multiplying by l .
5. The approximate length of air gap is determined by noting the (a/l) number nearest the point on the curve used in getting NI/l . This number is multiplied by l to get a .
6. The designer may now find that he cannot get the required number of turns in the winding space, or that the winding space is unnecessarily large. In either case he will make another assumption of depth of core d and try again.

CHOKES FOR LARGE RANGE OF DIRECT CURRENT

If the choke is to be used over quite a range of direct current, it is advisable to calculate the inductance at two or more values of current to make sure that there is not too much variation. The d.c. flux

density must first be obtained, using the formula

$$B = \frac{3.20 NI}{l/\mu + a}$$

Since (μ) is not known until B is, a cut-and-try method must be used. For a first approximation, consider $l/\mu = 0$ and calculate B . Take a slightly lower value of B , get (μ) from the permeability curve, and cal-

- L = inductance in henries
- N = total number of turns
- A = cross-sectional area of core and gap (sq. in.)
- l = length of magnetic path in inches
- a = total effective gap in inches
- B = flux density in lines per sq. in.

FLUX DENSITY

Though the design chart is all that is required in the design of the magnetic circuit of a reactance, it is often desirable to know

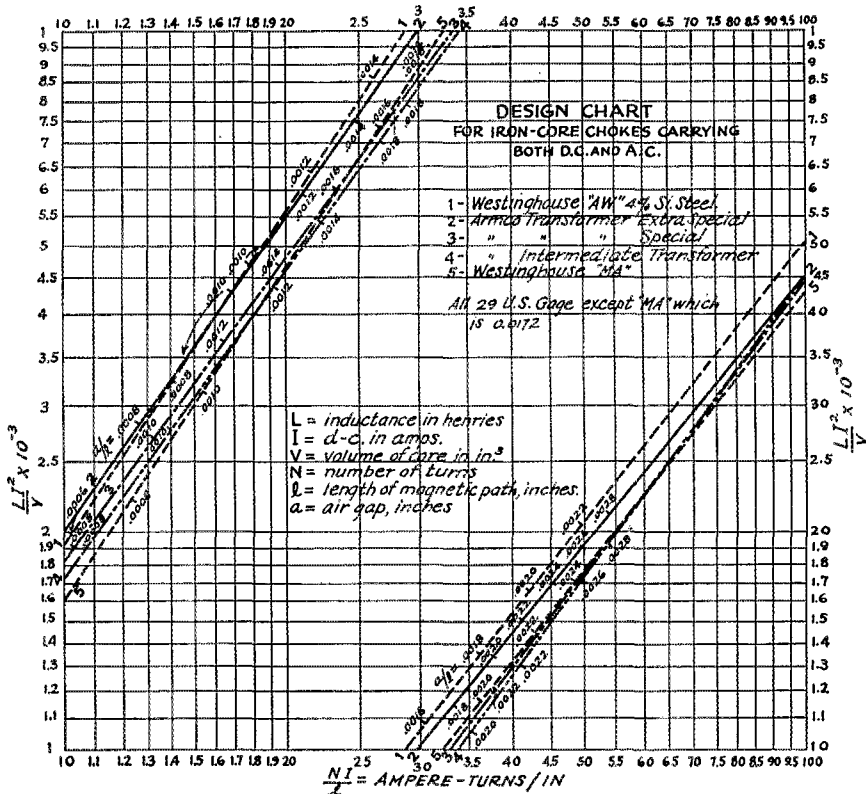

FIG. 4. DESIGN CHART $\frac{L^2}{V}$ vs $\frac{NI}{l}$

culate the value of B again. The correct value can be obtained after one or two trials.

With this correct value of B , the incremental permeability can be obtained from Fig. 2. Then,

$$L = \frac{3.20 N^2 A \times 10^{-8}}{l/\mu\Delta + a}$$

In these formulas,

the flux density used. Accordingly, Fig. 5 was plotted from data obtained from the design chart. It gives the flux density which will occur if the chokes are designed according to Fig. 3. It is rather interesting to note that with both grades of iron the flux density will be about 55,000 lines per square inch with large values of NI/l . These densities will be obtained if the air gaps of Fig. 3 are used. Smaller gaps will

increase the flux density, saturating the core and reducing the inductance. Larger values of gap length will reduce the flux, again decreasing the inductance.

SYNOPSIS OF METHOD OF CALCULATION EMPLOYED BY HANNA IN OBTAINING DESIGN CHARTS FOR IRON-CORE REACTANCES WHICH CARRY DIRECT CURRENT

In order to prepare the design chart, Fig. 4, both the normal and incremental

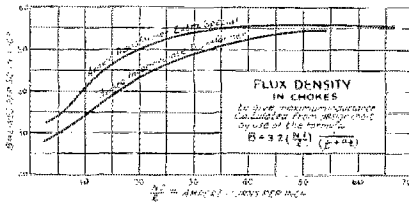

FIG. 5. FLUX DENSITY CURVE B vs $\frac{NI}{l}$

permeability curves, Figs. 1 and 3, are employed. Fig. 1 is readily obtained from manufacturers' saturation curves by use of the relation $\mu = BH$. Fig. 3 is computed for small values of a.c. from the data given in the paper by Spooner².

Then, using the following notations:

- B = Steady flux density in iron and air-gap, gausses.
- N = Number of turns in winding.
- I = Direct current, amperes.
- A = Area of core section, and air-gap, cm.²
- l = Length of iron path, cm.
- a = Air-gap length, cm.
- L = A.c. inductance, henries.
- μ = Normal permeability = $\frac{B}{H}$
- $\mu\Delta$ = Incremental permeability = $\frac{\Delta B}{\Delta H}$ where ΔB

and ΔH are the increments from tip to tip of a minor hysteresis loop. We have

$$B = \frac{0.4 \pi NI}{\frac{l}{\mu} + a} \tag{1}$$

and

$$L = \frac{0.4 \pi N^2 A \times 10^{-8}}{\frac{l}{\mu\Delta} + a} \tag{2}$$

From (1)

$$N = \frac{B \left(\frac{l}{\mu} + a \right)}{0.4 \pi I} \tag{3}$$

Substituting in (2)

$$L = \frac{B^2 \left(\frac{l}{\mu} + a \right)^2 A \times 10^{-8}}{0.4 \pi I \left(\frac{l}{\mu\Delta} + a \right)^2} \tag{4}$$

$$= \frac{B^2 \left(\frac{l}{\mu} + \frac{a}{l} \right)^2 1A \times 10^{-8}}{0.4 \pi I^2 \left(\frac{l}{\mu\Delta} + \frac{a}{l} \right)^2}$$

Letting $1A = V$, the volume of iron in the core,

$$\frac{LI^2}{V} = \frac{B^2 \left(\frac{l}{\mu} + \frac{a}{l} \right)^2 \times 10^{-8}}{0.4 \pi \left(\frac{l}{\mu\Delta} + \frac{a}{l} \right)^2} \tag{5}$$

Also from (1)

$$\frac{NI}{l} = \frac{B}{0.4 \pi} \left(\frac{l}{\mu} + \frac{a}{l} \right) \tag{6}$$

For any assigned value of $\frac{a}{l}$ (the per cent,

air-gap) equations (5) and (6) may be considered as parametric equations with B as the parameter, and a curve of

$\frac{LI^2}{V}$ against $\frac{NI}{l}$ can be plotted. To do

this, several values of B are assigned, and the values of μ and $\mu\Delta$ corresponding to B obtained from curves of Figs. 1 and 2. These values are substituted in equations (5) and (6) to determine corresponding values of

$\frac{LI^2}{V}$ and $\frac{NI}{l}$. $\frac{NI}{l}$ represents the steady ampere turns for each centimeter of iron length and $\frac{LI^2}{V}$ is a quantity which if

divided by the square of the current gives the inductance per cm.³ of core. It is seen that if $\frac{NI}{l}$ is increased, by increasing

N or I or by reducing l , $\frac{LI^2}{V}$ is greater for

larger values of $\frac{a}{l}$. Evidently the envelope of the family of curves gives the relation between $\frac{LI^2}{V}$ and $\frac{NI}{l}$ if the best value of $\frac{a}{l}$ is chosen. Since each curve of the

family corresponds to a certain value of $\frac{a}{l}$,

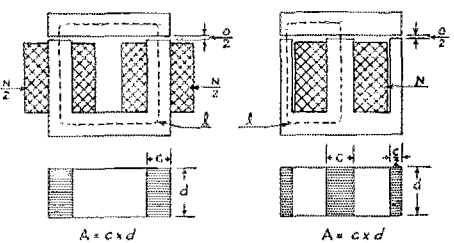

FIG. 6. TWO TYPES OF REACTANCES

the point of tangency with the envelope shows the value of $\frac{NI}{l}$ that requires this

$\frac{a}{l}$. Hence, along the envelope curve may be plotted a scale which shows the proper value of $\frac{a}{l}$. Fig. 3 shows the envelope curve with the $\frac{a}{l}$ scale along it.

This is the design curve which has been discussed in the foregoing paper in its extended form in which it applies to commercially available core materials for use in connection with filter circuit reactors.

Strays

Four of the leading entomologists of Buffalo, N.Y. have recently succeeded in discovering and capturing the specimen whose photo appears herewith.

This arthropoda is an elongate creature

not unlike the larvae of Ephemeroidea in form. The antennae are long, slender and quasi-spiral and the body cartridge-like in form. The mouth organs are mandibulate although somewhat subject to modifica-

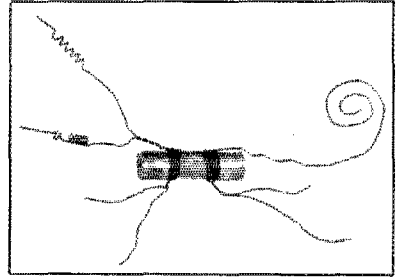

tions of a haustellate nature. Caudal setae are conspicuous by their absence as are the visual and aural appendages. It seems to have no proboscis, whatever. The tail, helically inclined has an inductance of 3.1416 micromillihenries which value is reduced 3 percent for each degree rise in temperature above 20 degrees Centigrade.

It is believed that the victim of this articulata finds it extremely difficult to indulge in the normal nocturnal slumber common to the species; man. Instead, he must sit awake night after night sending out into the ether innumerable calls somewhat resembling the code characters for the letters "C" and "Q" interspersing them with mixtures that are usually quite undecipherable even if one did happen to be curious enough to give the matter one's complete attention.

The disease is called hamophobia and although known for many years has never completely responded to any treatment. While it may be slightly alleviated it is, as far as is known, incurable. Perhaps the segregation of this specimen may result in rapid gains in the amount of knowledge concerning it which will result in the evolving of vastly superior methods of treatment for those poor unfortunate victims of its voracious appetite. If so, the credit is due in no small measure to 8BHX, 8AHO and the 8KW brothers.

It is said that you don't have to be crazy to be a radio enthusiast but it certainly helps a lot if you are.

—D. B. Parke

9EGU had a lot of trouble with his note on 20. He even went to the expense of an 852 in hopes of clearing it up. Imagine his feelings when he finally located the trouble as being a lot of dust in the antenna series condenser. We presume that the moral is to build a cabinet around your set or run the vacuum cleaner over it occasionally.

A Transmitter Without Transformers*

By L. W. Hatry**

THIS is a transmitting circuit for two tubes operated entirely from the 110-volt line without transformers and similar devices. The tubes are connected in what is known as "back-to-back" shunt-feed system, which provides a full-

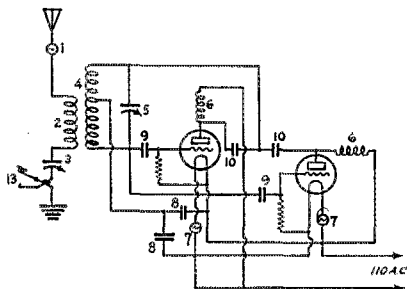

1. Flash-light lamp to indicate antenna resonance, should be $1\frac{1}{2}$ -volt bulb. The least candle-power is enough.
2. Primary coil on 3" diameter of 10 turns. Use bell-wire. Should have variable coupling to 4.
3. .00025 μ f. variable condenser.
4. 10 turns with tap in center on 3" diameter for 40 meters. Use bell-wire or larger.
5. .00025 μ f.
6. R. f. choke on 1" diameter of No. 30 wire, 200 turns.
7. Electric-light socket and 25-watt lamp, 25-watt lamp is for $\frac{1}{4}$ -amp. filament such as the 201-A, 60-watt lamps should be used for 112's or 171's, and 150-watt lamps for 210 type tubes.
8. Fixed condensers—.005 μ f. each.
9. Fixed condensers—.00025 μ f. each.
10. Fixed condensers—.00025 μ f. each.
11. Grid-leaks—25,000 ohms each.
12. Tube sockets.

wave, self-rectifying circuit. The best system of keying this circuit requires a double contact key in order that the connections to both grid-leaks may be opened at the filament end. The keying system shown requires two things; that the tubes used be large enough to dissipate the r. f. power internally when the key is "open", and that condenser 3 be used at a capacity value very appreciably larger than the self-capacity of the key, on the order of 6 to 10 times greater. The key should be connected exactly as shown in the diagram with the lever contact connected to the inductance. The plate voltage of each tube is at least the line a. c. voltage, or an r. m. s. voltage of 110. With the 171 or the new 250-volt power tube, this is a good little set.

*By permission of *Hartford Times*, original title, Standard Circuit No. 142.

**Radio Technican, *Hartford Times*.

Standard Frequency Transmissions from WWV

THE Bureau of Standards announces a new schedule of radio signals of standard frequencies, for use by the public in calibrating frequency standards and transmitting and receiving apparatus. The signals are transmitted from the Bureau's station WWV, Washington, D. C. They can be heard and utilized by stations equipped for continuous-wave reception at distances up to about 500 to 1,000 miles from the transmitting station.

The transmissions are by continuous-wave radio telegraphy. The signals have a slight modulation of high pitch which aids in their identification. A complete frequency transmission includes a "general call" and "standard frequency" signal, and "announcements". The "general call" is given at the beginning of the 8-minute period and continues for about 2 minutes. This includes a statement of the frequency. The "standard frequency signal" is a series of very long dashes with the call letter (WWV) intervening. This signal continues for about 4 minutes. The "announcements" are on the same frequency as the "standard frequency signal" just transmitted and contain a statement of the frequency. An announcement of the next frequency to be transmitted is then given. There is then a 4-minute interval while the transmitting set is adjusted for the next frequency.

Information on how to receive and utilize the signals is given in Bureau of Standards Letter Circular No. 171, which may be obtained by applying to the Bureau of Standards, Washington, D. C. Even though only a few frequency points are received, persons can obtain as complete a frequency meter calibration as desired by the method of generator harmonics, information on which is given in the letter circular. The schedule of standard frequency signals is as follows:

Radio Signal Transmissions of Standard Frequency Schedule of Frequencies in Kilocycles

| Eastern Standard Time P. M. | April | May | June | July | Aug. | Sept. | Oct. |
|-----------------------------|-------|------|------|------|------|-------|------|
| 10:00-10:08 | 3000 | 650 | 1500 | 3000 | 125 | 300 | 650 |
| 10:12-10:20 | 3500 | 750 | 1650 | 3300 | 150 | 350 | 750 |
| 10:24-10:32 | 3600 | 850 | 1800 | 3600 | 175 | 400 | 850 |
| 10:36-10:44 | 4000 | 950 | 2000 | 4000 | 200 | 450 | 950 |
| 10:48-10:56 | 4400 | 1060 | 2250 | 4400 | 225 | 500 | 1050 |
| 11:00-11:08 | 4900 | 1200 | 2500 | 4900 | 250 | 550 | 1200 |
| 11:12-11:20 | 5400 | 1350 | 2750 | 5400 | 275 | 600 | 1350 |
| 11:24-11:32 | 6000 | 1500 | 3000 | 6000 | 300 | 650 | 1500 |

Designing Fixed Resistors[†]

By R. C. Hitchcock*

AN alignment chart for the rapid calculation of the resistances of various kinds and sizes of wires is given in this article. The safe current rating of a resistor is also given, on two charts, for the usual current values used in amateur radio work.

Wire tables are available¹, manufacturers' booklets² give the required data, and an alignment chart has been published recently³ giving resistances. However, most of these references contain much extra material, while the charts in this article include only the essential data needed in calculating resistances and current ratings, and it is felt that they fill a need of the radio amateur.

The current carrying capacity of a wire is limited by the amount of heat which it can radiate. Especially in the case of resistors, where the wire has a higher resistance than that of pure copper, it is essential to provide surface enough to prevent the burning out of the resistance wire. It will be obvious that if a resistance wire is wound in several layers on a spool, its safe heat radiation will be smaller than for a similar length of wire wound in a single layer on a tube.

For average room conditions, the radiation value may be taken to be two watts per square inch of radiating surface⁴. Higher rates are sometimes used, but a conservative rating is two watts per square inch of surface. If a resistor is wound on a tube in which the air circulates inside as well as outside, the inside area can be included in figuring the surface.

SAFE CURRENT THROUGH A RESISTOR

The preceding paragraph gave the basis for constructing Figs. 1 and 2, which are charts representing the electrical law that $I^2R = \text{Watts}$, I being the current in amperes, and R the resistance in ohms. In Fig. 1 the column at the left gives the current in milliamperes, the center column gives the watts which must be dissipated, and the right hand column gives the resistance in thousands of ohms. Fig. 2 is similar except that the current scale is given in amperes, the resistance scale in ohms, and the watt scale is extended to cover a larger range of power to be dissipated.

*Research laboratory, Westinghouse Elec. & Mfg. Co., East Pittsburgh, Penna.

[†]The present paper is also known as Scientific Paper No. 272.

1. Smithsonian Physical Tables, Pub. by Smithsonian Institution, Washington, D. C.

2. Nichrome and Other Alloys, Driver Harris & Co., Morristown, N. J.

3. Journal Opt. Sci. Am. July 1927 p. 64.

4. Elements of Elect. Design, by Alfred Still, p. 21.

5. One one-thousandth of an inch.

In using these charts generally two of the quantities are known, and the third is found by placing a ruler on two values, the intersection with the third column giving the required quantity. As a typical example using Fig. 1, suppose that a ten-thousand ohm resistor has an area of three square inches, at the rate of two watts per square inch six watts can be radiated. Laying a ruler along ten thousand ohms and six watts on the chart, the current carrying capacity is found to be slightly less than twenty-five milliamperes.

To take another case to determine the necessary area, suppose a resistor is to carry forty milliamperes, and to have a resistance of twenty thousand ohms. Aligning these values in Fig. 1 it is found that about thirty-two watts must be radiated. Using the value of two watts per square inch, the required area is found to be sixteen square inches.

Fig. 2 is used in a similar manner for larger currents and lower resistances.

VARIETIES OF RESISTANCE WIRES

Ordinary soft iron or brass wires are satisfactory for low resistances but are not easy to obtain in the smaller sizes. In fact, if several resistors are to be wound, some one of the special wires is undoubtedly advisable. A table will be given showing the relative resistances of various wires, taking the resistance of copper as unity. Another useful factor included in the table is the resistance in ohms per circular mil foot. This is a fundamental property of a wire, as it is the actual resistance in ohms of a piece of wire one foot long, and having a diameter of one mil⁵. In the table it will be noticed that several names are given for one set of resistance values, the reason being that wires of the same composition are given a different name by different manufacturers.

From the table it will be seen that Nichrome or Calido wire has the highest resistance, having over sixty-two times as much resistance as a similar copper wire. This material makes a good resistor and will stand temporary overloads as it does not oxidize as much at high temperatures as some of the other wires. Advance wire, also, is resistant to oxidation at fairly high temperatures. There is one disadvantage in using Nichrome—its resistance rises slightly with temperature. At the temperature of boiling water (100°C) the resistance of a given Nichrome wire is 1.85% greater than at the temperature of freezing water (0°C). If a wire is wanted which has very small changes of resistance with temperature, Advance wire is recommended. With

the same limits as stated above, from boiling to freezing water, the resistance of an Advance wire is reduced by .08%. For a direct comparison, consider two 10,000-ohm resistors, one of Advance and one of Nichrome wire, these resistances being

RESISTANCE OF VARIOUS WIRES

The table gives nearly all the data needed to calculate the resistance of any kind of wire for any length. The one additional factor is the cross section of the wire, which is related to the gauge number, or the diameter. Fig. 3 is a chart which gives necessary data for finding round wire resistances for B. & S. gauges from 10 to 44, or from 101.9 to 2.0 mils diameter. The left hand column shows sizes both on B. & S. gauge, and the diameters in mils; the right hand column gives the resistance in ohms per thousand feet of wire. The center column can be used in two ways, the relative resistance is given on the right side of this column. The names of some of the common wires are given on the left side opposite their value of relative resistance. A few of the ordinary wires could not be included in the chart, due to crowding, but by referring to the table for relative resistances, their places on the center column can be found.

Two examples will illustrate the use of Fig. 3. Suppose the resistance of No. 30 B. & S. Advance wire is required. A lining size 30 in the left column and the line at the end of Advance in

the center column, the value of the resistance is found in the third column to be approximately 30,000 ohms per thousand feet, or 30 ohms per foot.

Suppose, to take a second example, that a ten-thousand ohm resistor of Nichrome wire is to be made. Lining up these values on the right and center column, the required size is seen to be closest to B. & S. size 32.

A chart such as Fig. 3 is useful in forming the approximate design of a resistor within a few per cent of the desired value. But the resistance is subject to manufacturing variations or perhaps less than five per cent, which is about the usual error in reading the chart. The use of a Wheatstone bridge, or a voltmeter-ammeter method of

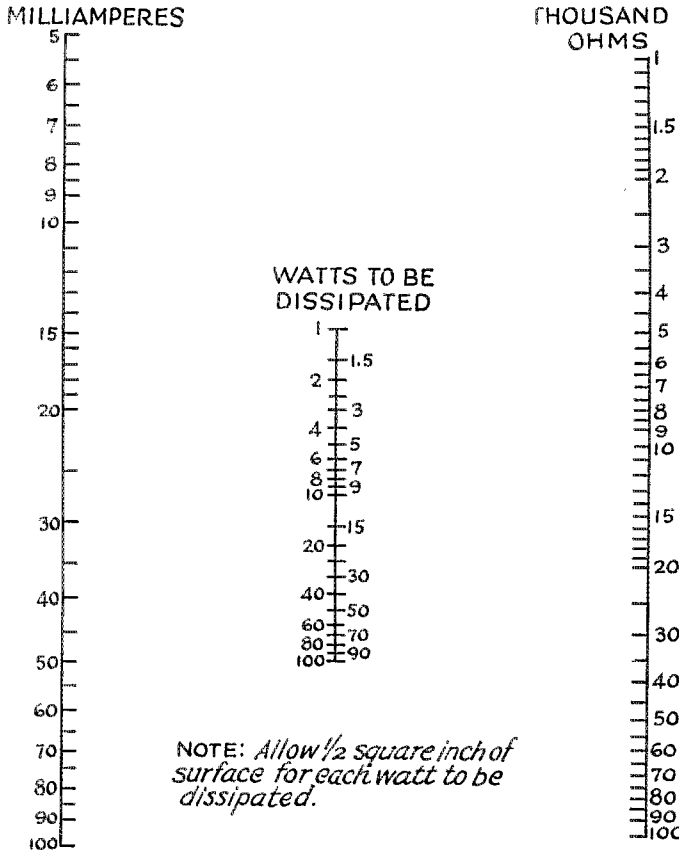

FIGURE 1

measured at the temperature of freezing water. At the temperature of boiling water the resistance of the Advance resistor will be 9,992 ohms, and that of the Nichrome will be 10,185 ohms. For a given wire size, Advance has less than one half the resistance that Nichrome wire has, and the choice has to be made between small space and low coefficient of resistance change with temperature. It should be understood that when in use, these resistors will rise several degrees above room temperature in dissipating the energy. It is the rise in the resistor temperature which changes the resistance value, and not room temperature changes, which ordinarily would be negligible.

measuring resistance is recommended for a final determination if the accurate resistance value has to be known.

FORMS FOR WINDING RESISTORS

There are several good kinds of forms on which to wind resistance wires. One which is easy to secure is the porcelain tube used in house wiring. If bare resistance wire is used it should be space wound by using string or thread between the wires, the string being unwound after the resistor is completed. If a gas or an electric furnace is available, Nichrome or Advance wire can be heated to a red heat, forming a thin insulating layer of oxide. The wires can then be wound touching each other, without short circuiting. Another material which is very satisfactory as a form on which to wind re-

ing requires elaborate equipment, in addition to finding a proper enamel. Most vitreous enamels will eat into the wire during the process of firing, which either destroys the wire, or greatly reduces its cross section.

Resistance wires can be purchased hav-

ROUND WIRE RESISTANCE TABLE

| Material | Relative Resistance | Resistance in Ohms per Circular Mil Foot |
|----------------------|---------------------|--|
| Copper | 1 | 10.55 |
| Aluminum | 1.63 | 17.3 |
| Brass | 3.34 | 40.5 |
| Iron | 5.80 | 61.1 |
| Platinum | 6.83 | 72.0 |
| Lead | 10.85 | 114.7 |
| Manganin | 25.6 | 270. |
| Advance, Constantan, | | |
| Eureka, Ideal | 27.9 | 294. |
| Climax, Phoenix | 47.5 | 500. |
| Nichrome, Calido | 62.6 | 660. |

FIGURE 3

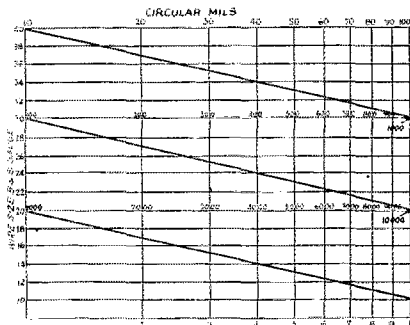

FIGURE 2

sistance wires is sheet mica. Sheets of two by three inches in size are not very expensive, and will stand heat better than almost any other insulator. A special advantage in using flat sheets for winding resistors is that the magnetic field is concentrated, causing little disturbance in nearby radio circuits. If the flat sheets are mounted vertically so that the heated air from the wires can rise freely from both sides of the sheet, radiation is aided, keeping the working temperature within reasonable limits. Mica wound resistors may look unusual to a person who is accustomed to seeing only the cylindrical enamelled resistors, but mica resistors are not a new untried idea, the heating element used in electric flat irons and in some toasters consists of a mica resistor. When using mica it is advisable to make small notches or slits in which to wind the resistance wire, so that if the wires expand with heat they will not move out of position and cause a short circuit with adjacent wires.

It is the opinion of the writer that the average experimenter should not attempt to make an enamelled resistor, as this cover-

ing the regular cotton or enamel coverings, but the extreme heat that is sometimes encountered by resistance wires in use is so great as to char a covering. For this reason covered wires are not often obtainable except from the manufacturers. However it should be kept in mind that in any ordinary use in a radio receiving set the heat will seldom be over a few watts, and if covered wires can be secured, there will be gained the advantage of being able to wind wires touching each other without making grooves for separation.

Shellac, waxes, or similar substances should not be put on a resistor as most of them soften at fairly low temperatures.

TERMINALS

Terminals should be fastened firmly to the form on which the resistance wire is wound and the wire wound tightly around the terminal and soldered if possible. If a wire like Nichrome which cannot be soldered is to be attached to a terminal, some clamping arrangement is generally the best. The wire should be carefully scraped and clamped tightly to ensure good contact.

If the wire is wound on a tube, a clamp like a radio ground clamp can be used as a terminal. If sheet mica is used, the terminal can be a machine screw with several nut sand washers, the first nut and washer holding the wire to the mica form, and the second to be used for attaching to the circuit where the resistor is to be used. A better terminal for sheet mica can be made by bending a copper or brass strip around each end of the resistor, drilling through both the metal strip and the mica and using a screw with nuts to clamp the wire. If a wire such as Advance is used, it can be soldered directly to the terminal strip.

Standard Frequency Transmissions

(Continued from page 14)

operating the station is done without charge by Chief Operator Hugh S. McCartney and his operating staff.

While no guarantee of accuracy is made on a gratis service, it is the aim of the staff to maintain an accuracy of 1/10 of 1%, which is materially better than can be "held" by most wavemeters. The frequency values are based on the Standards of the Bureau of Standards and have been checked by the Communications Laboratory of The Massachusetts Institute of Technology, also by Cruft Laboratory at Harvard University.

Important Notice—The continuation of this free service from month to month depends on the response received. Direct acknowledgments to "Experimenters' Section, A.R.R.L., 1711 Park Street, Hartford, Conn.," using ordinary stationery or else the special blanks supplied by the Experimenters' Section, on request. A goodly number of these blanks has been gathered and as the number grows we will gradually gain a unique and accurate record of transmission phenomena possible with no other station. Details on 9XL may be found on pages 8 of the June issue.

9XL now uses a small percentage of tone modulation to make the signal distinctive.

SCHEDULES

(Figures are frequencies in MEGACYCLES per sec.; approx. wavelengths in parentheses.)

| Friday Evening Schedules | | | | Sunday Afternoon Schedules | | | |
|--------------------------|-------------|-------------|------------|----------------------------|-----------|------------|---|
| Central Standard Time | | | | Central Standard Time | | | |
| Time (PM) | Schedule A | | Schedule B | | Time (PM) | Schedule C | |
| | f | λ | f | λ | | f | λ |
| 8:30 | 3.50 (85.7) | 6.50 (46.1) | 3:00 | 10.0 (30.0) | | | |
| 8:42 | 3.60 (83.3) | 6.75 (44.4) | 3:12 | 12.0 (25.0) | | | |
| 8:54 | 3.75 (80.0) | 7.00 (42.8) | 3:24 | 14.0 (21.4) | | | |
| 9:06 | 3.90 (76.9) | 7.25 (41.3) | 3:36 | 14.5 (20.7) | | | |
| 9:18 | 4.00 (75.0) | 7.50 (40.0) | 3:48 | 15.0 (20.0) | | | |
| 9:30 | 5.70 (52.6) | 7.75 (38.7) | 4:00 | 15.5 (19.3) | | | |
| 9:42 | 6.50 (46.1) | 8.00 (37.5) | 4:12 | 16.0 (18.7) | | | |
| 9:54 | 7.00 (42.8) | 8.25 (36.3) | 4:24 | 18.0 (16.7) | | | |
| 10:06 | 7.50 (40.0) | 8.50 (35.3) | 4:36 | 20.0 (15.0) | | | |
| 10:18 | 8.00 (37.5) | 8.75 (34.3) | | | | | |
| 10:30 | 8.50 (35.3) | 9.00 (33.3) | | | | | |

| | | |
|-------|----|---|
| March | 13 | A |
| | 16 | B |
| April | 1 | C |
| | 12 | A |
| | 27 | B |
| May | 11 | C |
| | 13 | B |
| | 25 | A |

DIVISION OF TIME

3 minutes—QST QST QST nu 9XL.
3 minutes—5 sec. dashes broken by station call letters every half minute.

1 minute—announcement of frequency in megacycles per second (8.75 megacycles per sec. is sent as "8 r 75 MC.")
1 minute—announcement of frequency in megacycles cycles per second.

Special Notice—If you use the transmissions send a note to Experimenters' Section, A.R.R.L., Hartford, Conn.

R. S. A.



AS REVISTA TELEGRAFICA OF BUENOS AIRES SEES THE WASHINGTON CONFERENCE
The European Majority: "Crush him, executioner; crush him!"
The Amateur: "Impossible. You can't squeeze me any flatter."

A Correction

An error occurred in the article "The DX Tape Measure" in the March issue. In the formula at the bottom of the second column on page 47 the figure 9.70193 should have been shown as the sum of the three logs above it. The line to indicate addition was misplaced.



BYE BYE PURTY BABY

8DPO

This Station is Built for the Future

MOST amateur transmitting sets are constructed around a particular size of tube without any thought of an increase in power in the future. In many cases this is thought to be necessary as the man wants to get a set on the air with the smallest expenditure of money. However, if it is desirable to increase power at a later date,

pleasing note that is easily picked up by the receiving operator and does not become wearying if one has to copy it for a lengthy period of time.

The oscillatory circuit, filament and plate transformers, and keying relay are all mounted upon the panel and baseboards. It is only necessary to run the 110-volt a.c. leads to binding posts provided for them,



A VIEW OF 8DPO

The transmitter is located on a separate table from the receivers. This table also holds the key and writing utensils. On the other table holding the receiver is the Bosch "B" supply and a General Radio wavemeter.

the cost is usually considerably more than it would be had the original parts been designed to work at the higher potentials and currents. These points were kept in mind and while the transmitter at 8DPO was primarily built to use a pair of UX-210s, the parts were so chosen that it would only be necessary to shift to larger tube sockets and a higher voltage plate transformer to use a pair of 50 watters.

The tuned-grid tuned-plate oscillatory circuit was chosen because it is stable in operation and easily adjusted. The two tubes are in a back-to-back or full-wave self-rectified arrangement which gives a

hook a key and battery to the relay and clip the antenna onto the plate inductance in order to put the set in operation.

The plate and grid tuning condensers are National double spaced units having a maximum capacity 450 μ fd. The plate and grid blocking condensers are R.C.A. type number UC-1846 and have a capacity of approximately 36 μ fd. Four of these are necessary and they are mounted in pairs on small stands. These, together with the tube sockets, r.f. chokes, and filament by-pass condensers are mounted on a small shelf which fits between the two tuning condensers. The two filament by-pass con-

densers which are Sangamo receiving type are mounted just beneath the tube sockets which are above the filament lighting transformer. They are of 2000 μ fd. capacity each. The various connecting leads are,

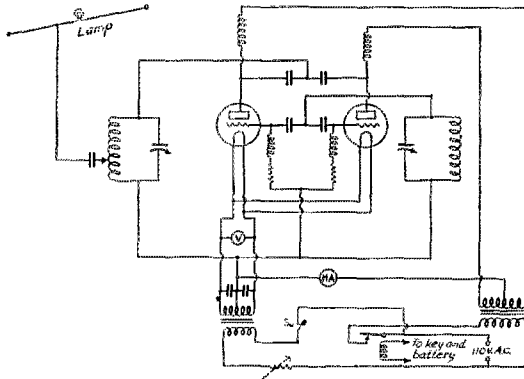

therefore, quite short and solidly mounted.

The plate and grid chokes are similar in construction and consist of approximately 175 turns of No. 30 d.s.c. wire wound on a one-inch bakelite tube. Only two of these chokes are visible in the photograph, the other two being located behind the plate and grid stopping condensers. It is always advisable to make the two grid chokes of exactly the same electrical constants unless some arrangement is provided whereby the chokes may be tuned. The same applies to the plate chokes although a difference in them will not be as damaging. In the absence of electrical measurements it is advisable to make them as near to being identical from a mechanical standpoint as can be done practically. If the chokes differ greatly, the output for the two tubes will not be similar and the note will be poor. It may also cause the wave to be broad and of an interfering nature. Of course, it is quite possible to have trouble of this nature if the tubes are not closely enough matched as to their electrical characteristics.

The inductances are made of quarter-inch copper tubing that has been heavily silver plated. The two coils for a band are similar in all respects. For the 40-meter band the coils are of four turns and are three inches in diameter. The two stems of the coils which fit into the clamps that hold them in place on the condensers are approximately five inches long. The 20-meter coils are of three turns each, their diameter and the length of their stems being the same as the 40-meter coils. The coils are firmly fastened to the condensers by means of brass fittings which are mounted on the condensers themselves.

One of these fittings takes the form of a heavy brass strap that is held by the tie rods which support the stator plates of the condenser. These tie rods are run out the back of the condenser as far as their length will allow so that the strap will be a satisfactory distance from the endplate and the screws holding the pieces of insulating material in place. The upper end of the strap holds a collar into which the end of the stem of the coils fits. This collar may be clamped tightly around the coil stem by means of a simple locking arrangement. A piece of rod is threaded at one end and its other end is turned at right angles to act as a handle by which it may be turned. The side of the collar nearest the handle end of the screw, is threaded so that the screw may be run in and out of it. The other side of the clamp has a larger hole that will clear the rod. The rod terminates in a nut which is kept from turning on it by a bit of solder. As the rod is screwed out of the threaded side of the clamp, the nut pulls against the other side and causes the clamp to contract. It can, therefore, be made to grip the stem of the coil very tightly giving an excellent electrical contact, providing the surfaces are thoroughly clean.

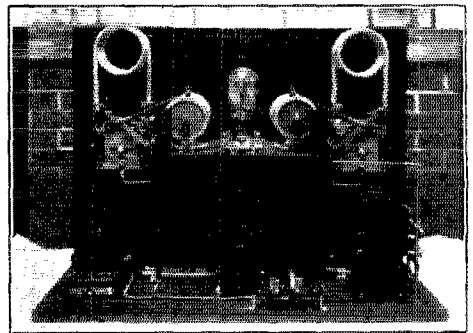

A LOOK AT THE 'WORKS'

Note the simple though effective arrangement used to hold the coils in place. The apparatus is mounted in a compact manner at the same time leaving plenty of space for getting at the various parts. The filament transformer is located at the center of the baseboard and the plate transformer and keying relay are at opposite sides of it.

The other clamp is fastened to one of the rods which holds the condenser frame together. It is really two clamps similar to the one described above. One of these clamps to the rod on the condenser frame and the other holds the coil stem. The proper relative positions of the two clamps to fit a given coil may be obtained by sliding the clamp on the support rod of the

condenser frame either backwards or forwards to a point where the coil is in its correct position. In this manner it is possible to use coils varying widely in their number of turns without it being necessary to vary the spacing between turns to make them all of a uniform length.

Separate grid leaks and condensers are used for the tubes which help in obtaining stable operation. It is possible that trouble may be encountered in operating tubes in a full-wave self-rectified arrangement which is due to the generation of parasitic oscillations of a very high frequency. The effect usually shows up in the form of excessive heating of the plates, erratic operation with varying output or it may be indicated by an inability to obtain or hold a smooth note. A remedy that is, in most cases, quite effective is to insert a center-tapped choke in the circuit at the point where the two grid circuits and the lead to the grid inductance connect. The outer terminals of the choke are connected to the leads from the grids of the tubes and the center terminal goes to the grid circuit inductance. Currents flowing from the center to the two grids will generate fields that oppose each other thereby giving a non-inductive effect while currents tending to flow from one grid to the other meet with the full impeding effect of the choke. For 20 and 40 meters such a choke may consist of about twenty or twenty-five turns of wire on a $\frac{3}{8}$ or $\frac{1}{2}$ -inch form. The size of the wire is not very important. Double-cotton covering would be useful as it would give sufficient spacing between turns without requiring special precautions in the winding to obtain this result. It is also possible to use resistors in the grid leads to prevent parasitic oscillations. However, the chokes are inexpensive and do the job in a satisfactory manner.

A 300-watt, 750-volt Acme transformer supplies power to the plates and the filaments are excited by an R.C.A. 150-watt affair. An Allen-Bradley radiostat is inserted in the 110-volt line to the primary of the latter and allows the filament voltage to be kept at the proper value as indicated by a Jewell 0-15 volt a.c. meter. Both transformer primaries are in series with a single-pole toggle switch. A pilot light behind a red bullseye is a positive indication as to when the power is on. The normal plate current is between 110 and 130 milliamperes as registered on a 0-150 Jewell milliammeter.

A pony telegraph relay is used for keying. It is inserted in the primary circuit of the plate transformer as this position will give less trouble from key clicks than will keying in the center tap or negative high voltage leads. Excessive arcing at the contacts may be prevented by shunting them with a half mike condenser in

series with a resistance. The value of the resistance may be between fifty and two-thousand ohms and can be determined by experimentation alone. If any trouble is had with key clicks, an adjustment of this resistor will usually help matters considerably. The key itself is connected in series with a six-volt storage battery and the relay winding thereby being entirely

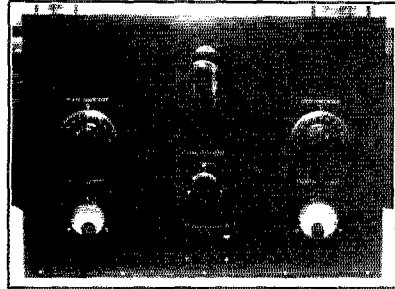

WHAT APPEARS ON THE PANEL OF THE TRANSMITTER

The toggle switch just below the knob of the Radiostat is in the primary circuit of both transformers and is, therefore, the main switch controlling the power supply to the set. The bullseye next to it indicates whether or not the power is turned on. The hole through which the tube is viewed is large enough so that one could get a full view of the plate of a 203-A were that type used.

isolated from the higher voltage circuits.

The 39-meter antenna used with the transmitter is of the Hertz type. It is approximately sixty-four feet long and thirty-five feet high and is supported by two telephone poles that are used for masts. At the exact center of the antenna there is a ten-watt thirty-two volt Mazda lamp. The feeder line, which is a single wire, is taken off at a point that is exactly halfway between the lamp and one end of the antenna. This feeder may be twenty-five or one hundred twenty-five feet long without effecting the wavelength of the system. Pyrex insulation is employed throughout and the feeder enters the house through bowl insulators and connects to the feeder series condenser which can be seen to the left of the lead-in insulator. This condenser is a UC-1803 unit of 25 μ fd. capacity.

There is also a 19.5-meter Hertz which is almost 32 feet long and the same height as the 39-meter one. Its current indicating and feed system is closely equivalent to that of the larger antenna. A switch located just outside of the window may be thrown to connect the 19.5- or 39-meter antenna to the set. The same lead-in through the wall is, therefore, used for both systems. No ground connection is used on either wave.

(Concluded on page 42)

The UX-250—CX-350 Tube

THE very excellent little CX-350—UX-250 tube is the unhappy victim of more hard luck than the heroine in an old-fashioned serial movie. Mad-house rumors have surrounded it for 6 months, and now its own folks are not agreeing on the story they will tell in announcing it. As if that isn't enough the samples have come through with such amazing slowness that *QST* even at this date has been compelled to go out and borrow some from a good friend in order to have some chance of finding out just what to believe.

THAT FAMOUS "25-WATT" RATING

The grapevine telegraph was busy for many months announcing the 250 as a "25-watt, 200-volt tube". That at least can be knocked on the head at once. The 250 is so far from being a 25-watt tube at 200 volts that it has little (if any) advantage over the 171 at that plate voltage.

The next question is, 'Is it ever a 25-watt tube?' As to that, we will tell the story as it has been shown us, after which your guess will be as good as another's.

A. The rumors made it a 25-watt tube.

B. The R.C.A. mimeod release says, "When used as a transmitting tube the UX-250 is rated at 25 watts as against the 7.5-watt rating of the UX-210".

C. Consideration of the amplifier ratings and of the structure of the tube made it seem that perhaps the typist had hit the wrong key in cutting the stencil.

D. In response to our questions, R.C.A. cannot stand such high temperatures. On the other hand it is larger. Cancelling these things against each other one arrives at the conclusion that the 250 ought to be able to stand about twice the plate dissipation of the 210. Rough tests seemed to show that a pair of 210 tubes in parallel were a bit more than equivalent to a 250.

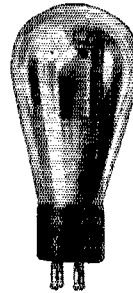

All of this suggests that the typist should have hit the "1" key and made the rating "15 watts", unless the idea is to rerate the other tubes of the line, which might not be a bad idea at that, the present ratings being ultra-conservative as compared to the foreign tubes we have used. Certainly, with high-efficiency circuits it is possible to obtain more than rating from all of the older tubes of the R.C.A. line.

Meanwhile, whatever the proper rating may be, the UX-250 is a fine little oscillator, even if such activities are not approved by its makers!

AS AN AMPLIFIER

In table A, the figures for the UX-210 are taken from standard information of

TABLE A

COMPARISON OF UX-210 AND UX-250 AS AMPLIFIERS. BRACKETED VALUES REFER TO 210

| Plate Voltage | 250 | 350 | 425 | 450 |
|-------------------------------------|-------------|--------------------|------------|----------|
| Negative Grid Bias | (18) 45 | (27) 63 | (35) ——— | (—) 84 |
| Plate Current | (12) 28 | (18) 45 | (22) ——— | (—) 55 |
| Mutual Conductance | (1330) 1800 | (1500) 2000 | (1500) ——— | (—) 2100 |
| Mu. | (7.5) 3.8 | (7.6) 3.8 | (7.7) ——— | (—) 3.8 |
| Max undistorted output (milliwatts) | (340) 900 | (925) 2350 | (1540) ——— | (—) 4650 |
| Fil. Volts | | (7.5) 7.5 | | |
| Fil. Amp. | | (1.25) 1.25 | | |
| Ht. | | (5-3/8") 6-3/4" | | |
| Dia. | | (2-3/16") 2-11/16" | | |
| Base | | Same -UX Std. | | |

says in a letter, "No information has been given as to oscillator ratings of the UX-250. This tube is, in fact, not recommended for use in transmitting circuits, contrary to information given out by various newspapers."

About the only choice that leaves, is to try manufacturing some information from comparisons with the 210 and from trying the tube. The plate of the 250 is of a less refractory metal than that of the 210 and

R.C.A. and the figures for the 250 are taken from the same release which gave the 25-watt oscillator rating, and which may therefore need some later adjustment. The bracketed figures are those of the 210.

AS AN OSCILLATOR

With the incomplete data at hand oscillator comparisons must be made indirectly. Referring back to the UX-210 we take

(Continued on Page 38)

Keying Master-Oscillator Circuits

By Beverly Dudley*

IN keying master-oscillator circuits we have the choice of keying (1) the oscillator, (2) the amplifier, or (3) both the amplifier and the oscillator.

If the oscillator is keyed, there is a possibility that key clicks will be present in the emitted wave. A further disadvantage in keying the oscillator is the fact that the wave is not as steady as if the oscillator were kept running continuously. This unsteady state or creeping, may change the emitted frequency as much as several hundred cycles. Each time the key goes down and the tube heats its elements expand and change the frequency of the emitted signal. The *single* advantage of keying the oscillator in master-oscillator circuits is that keying is positive.

Keying the amplifier has the advantage that the oscillator does not creep, and the signal is consequently easier to read. Key clicks are apt to be present when keying the amplifier but do not seem quite as pronounced as when keying the oscillator. The disadvantage of most methods of keying the oscillator is that some energy is radiated from the oscillator¹ even when the key is in the up position.

Keying both the amplifier and the oscillator makes for definite action, but key

inate key clicks, or reduce their effects to a negligible value, and (3) to accomplish keying with a medium of apparatus.

A study was made as shown in Fig. 1. By keying in the negative side of the plate supply (A) both the oscillator and the amplifier were very effectively keyed but key

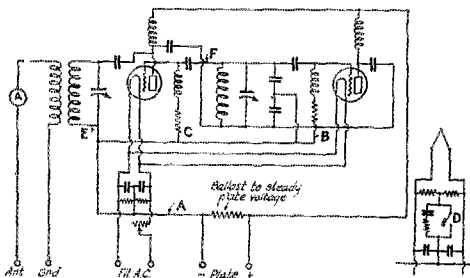

FIGURE 1. KEYING TESTS

clicks are often present, and the arrangement has the further disadvantage of creeping.

Key clicks may of course be eliminated, or their deleterious effects greatly reduced, through the use of a key thump filter. In keying a small, and low power master oscillator circuit, it was desired to (1) secure definite and positive keying action, (2) elim-

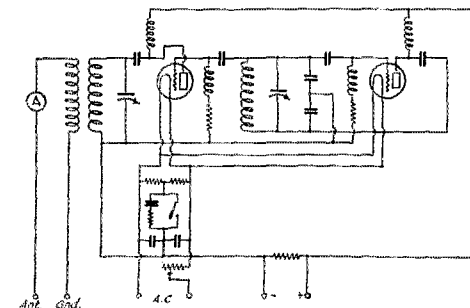

FIGURE 2. THE CENTER TAP METHOD OF FIG. 1 AS USED AT 9BR

It will be noticed that in this circuit and the one of Fig. 3 the amplifier is not "neutralized". This has nothing to do with the keying method and will be explained in a later paper.

clicks were very pronounced and a key thump filter would have been necessary for operation. If possible a key thump filter was to be eliminated to fulfill condition (3) named above.

The grid circuit of the oscillator was keyed by placing the key at the point B. Action was definite and sure. Key clicks were not as bad as when keying in position A. In both positions A and B, the oscillator had a tendency to creep, and while this was not bad when sending dots, the frequency and power output varied noticeably when sending long dashes and this method of keying was eliminated for this reason.

The key was next inserted at C in the grid circuit of the amplifier tube. The keying was found to be rather erratic. Furthermore, a considerable portion of the full power of the transmitter was being radiated when the key was up, and it was not found possible to set the neutralizing capacity to such a value as to cut the antenna current down to zero without producing a strong tendency of the amplifier to oscillate. If the neutralizing capacity was adjusted to prevent the amplifier from oscillating, the antenna current was about 10% of its full value even with the key up. If the neutralizing capacity was adjusted to cut the antenna current to zero, the am-

* Technical Editor, Chicago Evening Post; 9BR, 4739 Central Park Ave., Chicago, Ill.

1. That is to say some power from the oscillator reaches the antenna by accidental coupling even when the amplifier is not working. This happens in practically all oscillator-amplifier transmitters though the operator frequently does not know it.—Tech. Ed.

plifier was nearly always found to oscillate or was found to be unstable. I do not understand just why this should occur.

In playing around with different keying methods, we came across the method of "common lead" or "center-tap" keying shown in D. This arrangement effectively stopped both the amplifier and the oscillator without causing objectionable clicks. In fact, key clicks could barely be heard on a three circuit regenerative receiver used for broadcast reception, located three feet from the transmitter. This circuit was used for some time but the wave was found to creep.

By keying at point E, the oscillator was kept warm throughout the entire transmission so that the tendency to creep was eliminated. No key clicks were heard with this arrangement, and in addition, operation was positive, the antenna current being zero when the key was up. The key at E is at low potentials, both d.c. and r.f. as the center tap on the filament is usually grounded.

It is not necessary to employ condensers and resistors in shunt with the key in this position. Due to the load of the antenna,

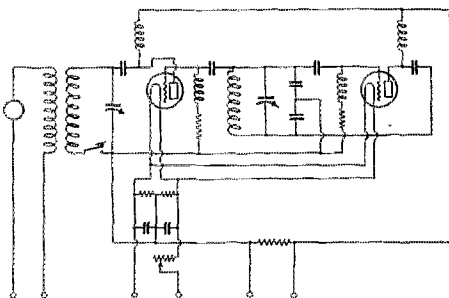

FIGURE 3. THE METHOD OF KEYING BY BREAKING THE RADIO FREQUENCY PLATE CIRCUIT OF THE AMPLIFIER AT 9BR

While probably less suited to high power work this method is thoroughly satisfactory from the standpoint of the receiving operator and the nearby broadcast listener and also has the advantage of not requiring a keying filter.

the frequency of the emitted signal several thousand cycles different than the frequency of oscillations when the oscillator is running idle. However, the transmitter can be adjusted to give the desired emitted wave, and as no power is radiated when the key is up, it does not matter if the oscillator maintains a different frequency when idle than when feeding the antenna.

The key was also inserted at the point F, but due to the capacity of the key and its associated leads, so much r.f. energy was by-passed that keying was impossible.

The keying methods shown at D and E, (Fig. 1) were found to be the best of all

the keying systems tried. The keying system shown at D was used for quite a while. The complete circuit using this keying method is shown in Fig. 2. However, the keying system shown at E operated better than position D, and had the advantage of not requiring the use of relays, key thump filters, or other accessory apparatus. The final circuit used is shown in Fig. 3. The final keying system used has the disadvantage of supplying d.c. to the plate of the amplifier at all times. This has never been found objectionable in the case of 210 tubes, but might prove so in the case of larger tubes.

The resistance across the plate supply is simply used to "empty the filter" as a filter having a total inductance of 50 H. and total capacity of 9 mfd. as used here retains its charge a long time.

The UX-250—CX-350 Tube

(Continued from Page 36)

from the Sept., 1926, issue of *QST* some General Electric data to indicate how the amplifier rating and oscillator rating of a tube of this general type may be expected to compare. The following figures are correct for an older type of 210 but the general proportions of the picture may be expected to apply to the present 210 and to the 250.

| | As amplifier | As oscillator |
|-----------------------|--------------|----------------------------|
| Plate volts | 425 (max) | 350 |
| Plate mils | 30 (max) | 60 |
| Input watts | 12.7 | 21 |
| Rated safe plate loss | 12 | 15 |
| Output watts | | 7.5 watts at eff. of 37.5% |

Note that the max. amplifier input rating is approximately equal to the max. safe plate loss when used as amplifier (naturally since the plate circuit input is mainly plate loss when the tube is not working for a moment) also that the oscillator plate loss is 5/4 of this.

Referring that to the 250 we have a max. input rating of 55 mils at 450 volts which is 24.8 watts, suggesting a plate dissipation of 24 watts when resting as an amplifier. Following the assumption, we have 5/4 (24) = 30 watts plate dissipation as an oscillator which compares nicely with the 2-to-1 result of the rough test mentioned above.

Finally, if we assume the same 37.5% efficiency for this tube as was used in rating the 210 we have an oscillator rating of 15 watts and an input of 42 watts at a plate voltage of ? ? ? and a current of ? ? ?.

All of which is another method of guessing, but arrives at the same result.

—R. S. K.

Easy Tuning in the Short-Wave Bands

By F. Austin Lidbury *

THE increasing use of plug-in-coil receivers brings out the suggestion that those who do not mind using a few extra coils in such receivers can obtain much greater ease of tuning by the use of a condenser in the tuning circuit with a high ratio of minimum to maximum capacity. A condenser which will vary from 25-to 50- μ mf (shunted as it is by tube capacity and other capacities of an unavoidable nature) will usually tune a coil of the proper inductance and fairly low distributed capacity over a range equal to one of the short wave bands with a slight but comfortable margin. Three properly proportioned coils will therefore cover the 20-, 40- and 80-meter bands respectively; five or six intermediate coils will be necessary to cover the ranges between.

Such a condenser can readily be made from a Cardwell 250 μ mf. variable by removing the 1st, 3rd and 5th of the five stator plates, and all but one of the rotor plates. This gives a double-spaced variable of about 25 μ mf. To this is added about 25 μ mf. of *fixed capacity* by supporting another plate (which is connected to the frame and is therefore equivalent to an additional rotor plate) about 1/16" from the back stator plate, by drilling out the threads from the three holes which will be found on the back end-plate, threading and riveting three 6-32 bolts (from which the heads have been cut) at corresponding places on the extra plate, which is thus held firmly to the back end-plate by 2 nuts (one each side of the end-plate) on each of the bolts. (See photograph.) This gives also an easy method of adjusting the value of the fixed or minimum capacity, by increasing or decreasing the distance of the extra plate from the back stator plate.

WAVEMETER CONDENSER

A condenser which fills the rather severe requirements for use in a wavemeter capable of really accurate work in the higher frequency bands can be made as follows:

Start with a General Instrument Type 51 F—.001 variable condenser. This has 22 rotor plates and 21 stator plates. Counting from the "panel" end, remove all but the

2nd, 5th, 8th, 11th, 14th, 17th and 20th of the stator plates: and all but the 1st, 4th and 7th of the rotor plates. If you reassembled the condenser at this stage there would be 7 fixed plates and 3 movable plates, one outside and two meshing with the front fixed plates. It is now necessary to provide, between the remaining fixed plates, four plates which, though grounded like the rotor plates, are not attached to the rotor and remain "in," whatever the position of the rotor. This is done by so shaping four flat brass plates that (while having ample clearance from the slotted metal pieces to which the stator plates are attached, as well as clearance for the shaft) they each have three projecting arms which can be fastened to the two top and center bottom hexagonal rods which separate the end plates of the condenser. These should then be firmly fixed in positions exactly between the five remaining rear stator plates, preferably by slotting the hexagonal rods referred to and soldering the brass plates in position. You now have, on reassembling, a condenser with seven insulated stator plates and seven

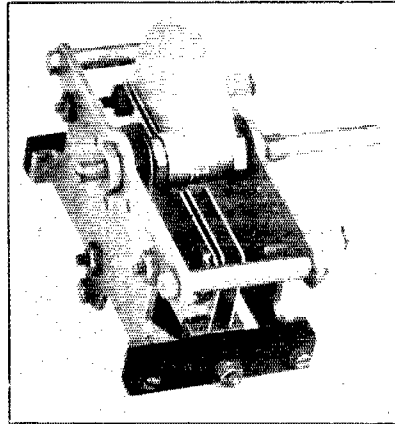

THE RECONSTRUCTED CARDWELL CONDENSER

The grounded fixed plate can be set at various distances from the insulated stator.

*Experimenters' Section, A.R.R.L., Box 619, Niagara Falls, New York.

1. There is a very general idea that the goodness of a tuner is determined by the smallness of the tuning condenser and that a very high L/C ratio proves that the tuner is excellent. There is room for argument on this point because the story isn't all told by L and C; we must also consider the R of the coil, which goes up as L goes up. See Glenn H. Browning's "Rating Circuit Resistance," page 42 of QST for December, 1925.—Tech. Ed.

grounded plates, of which four are permanently and immovably "in" and three (attached to the rotor) variable. On reassembling, care should be taken to tighten up all bolts thoroughly: preferably they should then be soldered in position.

A condenser so prepared has the following properties all of which are desirable in a

wavemeter for precise work at higher frequencies:

(1) Rigidity of construction and absence of wobble at shaft bearings. The extremely wide spacing further assists the maintenance of constant and reproducible values of capacity at a given setting.

(2) Good electrical characteristics.

(3) Such a high ratio of minimum to maximum capacity that a suitable inductance will cover but one of the amateur wave bands with a slight leeway at each end.

In the latter respect a wavemeter built with such a condenser differs radically from those generally in use, which cover with each

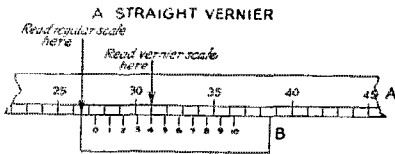

A - Regular Scale
B - Vernier Scale, 10 divisions here equal to 10 on main scale

METHOD OF READING
On scale A read 27, then follow along until a line on A agrees with a line on B. This happens at 4, therefore entire reading is 27.4.

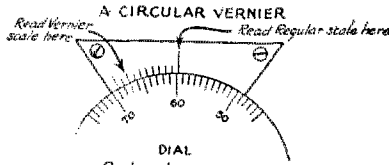

VERNIER SCALES

coil such an enormous frequency range that close tuning is impractical. A wavemeter built along the lines of that described in the Bureau of Standards Letter Circular 185, but using a condenser such as described above, has a useful frequency range with each coil of radio approximately 1:1.16; thus the 40-meter coil covers a range from 37.4 to 43.4 meters. Very sharp tuning is possible, and by using a "vernier," readings can be reproduced to 1/10 of a division of 100-scale dial, or somewhere in the neighborhood of .01%. This is a considerably higher degree of accuracy than under present conditions an absolute calibration can be obtained for. It is not higher, however, than will be found desirable, and necessary next year.

2. The word "vernier" is here used in its earlier (and more correct) sense, i.e., that of a device for reading tenths of scale divisions by means of a stationary scale which has 10 divisions, each of which is 9/10 of the length of a division of the moving scale. The 10 divisions of the fixed scale therefore cover 9 divisions of the moving scale. The device is familiar from its use on micrometer callipers and surveyor's instruments.—Tech. Ed.

Financial Statement

BY order of the Board of Directors the following statement of the income and disbursements of the American Radio Relay League for the fourth quarter of 1927 is published for the information of the membership.

K. B. WARNER Secretary.

STATEMENT OF REVENUE AND EXPENSES FOR THE THREE MONTHS ENDED DEC. 31, 1927.

| REVENUE | |
|---|--------------------|
| Advertising sales, QST | \$18,844.38 |
| Newsdealer sales | 17,511.18 |
| Handbook sales | 3,458.81 |
| Handbook advertising sales | 1,297.60 |
| Dues and subscriptions | 9,515.01 |
| Back numbers, etc. | 758.19 |
| Emblems | 77.81 |
| Interest earned, bank deposits ... | 111.22 |
| Cash discounts earned | 366.05 |
| | \$51,937.65 |
| Deduct: | |
| Returns and allowances | 6,692.93 |
| Provision for newsdealer returns .. | 2,324.71 |
| Discount 2% for cash | 337.72 |
| Exchange and collections | 10.65 |
| | 9,366.01 |
| Net Revenue | 42,571.64 |
| EXPENSES | |
| Publication expenses, QST | 15,745.25 |
| Publication expenses, Handbook .. | 2,783.30 |
| Salaries and commissions | 16,650.33 |
| Forwarding expenses | 735.58 |
| Telegraph, telephone and postage .. | 1,241.17 |
| Office supplies and general expenses .. | 2,194.90 |
| Rent, light and heat | 933.93 |
| Traveling expenses | 1,113.46 |
| Depreciation of furniture and equipment | 235.17 |
| Bad debts written off | 278.60 |
| Communications Dept. field expenses | 104.90 |
| Total Expenses | 42,016.59 |
| Net Gain from Operations | \$ 555.05 |

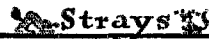

If you work a station signing okMNX don't write in and tell us you've snagged a new one. His QRA won't be worth having because it will be some non-existent place in Africa, Siberia or what have you. Several stations have been "worked" by okMNX and as near as we can make out it is the call used by members of Barney Google's Billy-Goat Club.

We were mighty pleased to hear that John M. Clayton who is well known to readers of QST has recently been appointed as secretary to the Institute of Radio Engineers succeeding Dr. Alfred N. Goldsmith who is now president of the Institute. Hearty congratulations from all at hdqs. go to J. M. C. on his advance.

A Portable Receiver

By James J. Lamb*

THE major points considered in the design and construction of the receiver were that it should be sturdy and compact, self-contained, totally shielded, and adaptable to use with a short-wave r. f. amplifier or super het.

The panel is of $\frac{1}{4}$ inch hard rubber stock, 7 by 12 inches in size and backed with aluminum shielding 1/16 inch thick. The hard rubber was first marked and drilled for instruments to be mounted and then this panel was used for the template in drilling the aluminum shield. The holes in the shielding were drilled sufficiently large to pass all shafts without contact with the exception of the tuning condenser shaft bearing, which is grounded. Mica paper insulation was used to insulate the shell of the regeneration control resistor, the shell of the volume control resistor, the

bodies the features recommended by the Technical Staff of *QST* in recent issues. The plug-in inductances are wound on UX tube bases, and an UX socket is used as a

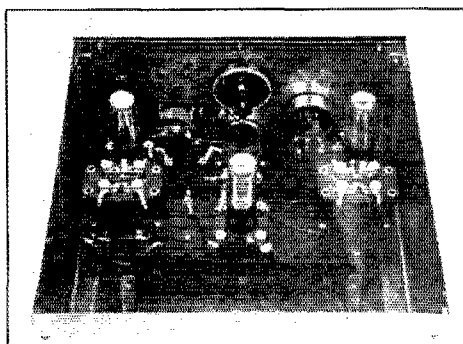

REAR VIEW TO SHOW INTERIOR ARRANGEMENT

Four sockets are provided, three for tubes and one for the tuning coils. The batteries have been removed to expose the apparatus.

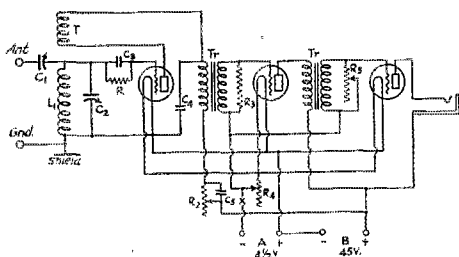

THE DIAGRAM WITH CONSTANTS

- C1 50- μ fd General Radio miniature variable used in series with antenna.
- C2 Same as C1, used to tune L1
- C3 100- μ fd Sangamo mica grid condenser.
- C4 Sangamo 1000- μ fd mica bypass condenser.
- C5 .25- μ fd Tobe fixed condenser.
- R1 5-meg. gridleak.
- R2 50,000-ohm Frost rheostat for regeneration control.
- R3 1-meg gridleak for preventing fringe howl.
- R4 20-ohm Yaxley Filament rheostat.
- R5 500,000-ohm Frost rheostat used as a gain control.
- Tr Stromberg-Carlson audio transformers. National dials used.

filament switch, the filament rheostat and the phone jack. Empire cloth or similar sheet insulation material would be equally serviceable.

The sub-panel is mounted on Benjamin aluminum brackets, and carries on its top the inductance socket, tube sockets and audio transformers. Bolted to the back of the sub-panel brackets is a hard rubber strip carrying the binding posts and antenna series condenser.

The circuit is quite conventional, and em-

mounting. Regeneration control is by means of a Frost 50,000-ohm maximum variable resistor, shunted by a .25- μ fd. fixed condenser to eliminate any tendency to scratching noises.

The first audio transformer has a 1 megohm resistance shunted across its secondary to eliminate fringe howl, and this it does with no loss of signal volume. This resistor may have to be of lower value with some transformers of different make or type. The second audio transformer has its secondary shunted by a Frost variable resistor having a maximum resistance of 500,000 ohms, and this serves as a volume control of infinite variation, being not only useful in controlling signal volume, but also in attaining a more favorable signal to static and background ratio on weak signals.

The cabinet is made of 1/16 inch aluminum sheet, and is 12 inches wide, 12 inches deep and 7 inches in height. The corners are formed of pieces of the aluminum stock bent in the form of right angles, and the pieces forming the panel shield, sides, bottom and back bolted to these angles. The top is made of a sheet 12 by 12 inches, with angles bolted to the under side so as to fit snugly against the sides of the cabinet when the top is in place. The top is not hinged, and is therefore completely and quickly removable.

*3CE1, ex3CE1, care Dr. James J. Cahill, 2607 Connecticut Ave., Washington, D. C.

The set uses three tubes of the 199 type, and the requisite dry-cell A battery and 45 volt B battery are contained in the cabinet.

In operation, the receiver "handles" very well, having no body-detuning effects or

(there is no primary coil so this name is hardly appropriate) coil is in each case the upper one, the tickler being nearest the base. Longer forms may be used with the same plug-in arrangement and go into the broadcast band.

The outer carrying case is an ordinary hinged one made for traveling.

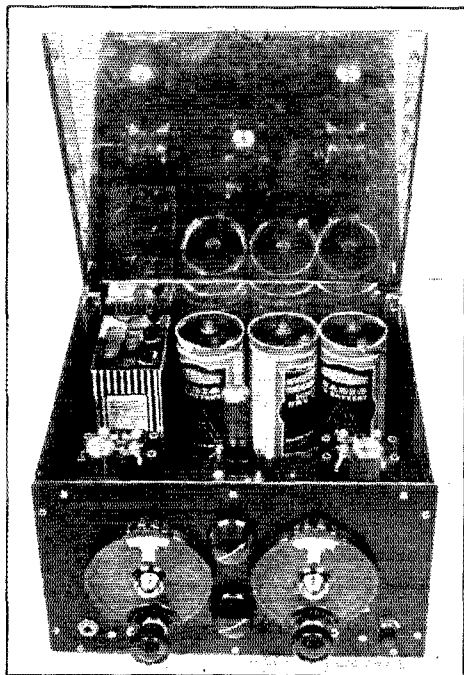

FRONT VIEW OF THE SET WITH BATTERIES IN PLACE

Everything is ready for reception except the antenna, which is simply a length of small magnet wire that can be taken down readily, wound up and dropped into the pocket or the set. The left National dial controls the regeneration, the right one the tuning. The upper rheostat controls the filament, the lower one the gain in the audio system. The filament switch is at the lower right and the phone jack at the lower left.

noises from the variable condenser and regeneration control. The variation of the regeneration control has no detuning effect on the signal, and the regeneration control has been found very satisfactory on the reception of phone signals.

The coils are wound on ordinary UX tube bases. Those that have been made so far are as follows, all wound with No. 28 D.S.C.

| Wavelength range | Tuned coil (grid input) | Tickler |
|------------------|-------------------------|---------|
| 43.5—28.5 | 11 x 1/4 | 9 1/4 |
| 17.5—26 | 6 | 6 |
| 10 meter band | 3 1/4 | 5 1/4 |

The tuned, or grid input or "secondary"

8DPO

(Continued from page 35)

The receiver is of the popular type using Aero Coils and capacitive control of oscillation. The plate voltage is obtained from a Bosch "B" supply and it is found that the knob which controls the detector voltage may be advantageously used as a control of oscillation. It helps greatly in "building up" weak signals. A ground connection to a cold water pipe is used on the receiver. An antenna that is 135 feet long has been found to be the best that has been tried here for receiving.

The station which is located at 136-11th Street, Warwood, Wheeling, W. Va., is the property of Mr. Ross J. Arrick. It is operated by him and Mr. John F. Niess and was constructed by 2AMB located at Woodbridge, N. J.

Strays

9CGY had a lot of trouble getting a d. c. note from his transmitter and, after trying everything else he could think of, discovered that what was needed was an adjustment of the center tap of the filament transformer. He finds now that he can change the note from r. a. c. to d. c. just by shifting the contactor on the potentiometer shunted across the filament transformer. Perhaps such a stunt might help some of the notes one hears on the air; it certainly couldn't do any harm to them.

Overheard at the local BCL club, "Well, Sir! I put a lot of thumb tacks along my aerial—I don't know why I did it—but—ad nauseam."—5CO.

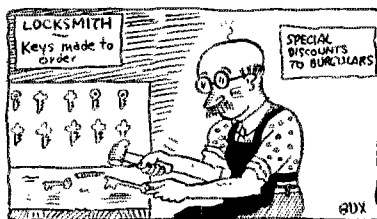

POUNDING THE KEY

Variable A-, B- and C-Power From D.C. Mains

By F. I. Anderson*

DIRECT current supply is available in large areas of many cities and towns, and since the system of distribution smooths it out very nearly flat, it isn't much of a job to take out the residual hum. The beauty of it is that it will furnish A, B and C-power for receiving sets at practically no cost, which (being almost something for nothing) should appeal to the ham. I give below the hook-up I have been using in New York City for the past year.

The diagram is self-explanatory. My choke is an Amertran 418, which will carry 3 amps without appreciable drop. I use "five-and-ten" carbon lamps (115 volts) in series for the divider circuit, from which the B voltages are drawn. Variable resistances may be used instead.

The rheostat controlling the A voltage is reversed, because it is used as a by-pass. The more current is by-passed through the rheostat, the lower the voltage in the tubes, and vice versa. Take an ordinary rheostat (say of 50 or 60 ohms) and mount it backwards, so that when you turn it "on" (to the right) you really turn it "off"—if you know what I mean! The rheostat and voltmeter are both, of course, in parallel with the filaments.

Your reading lamp is used to trim the voltage for the filaments. Since we only take away 5 volts for the filaments, the reading lamp doesn't know the difference, and we continue to use the lamp for the purpose for which it was intended. Of course if you listen in daylight, the reading lamp is so much waste; but at night the radio beneficently furnishes light for nothing, or the reading lamp beneficently furnishes radio power for nought; as you please. The size of your reading lamp—this being really a check-valve on amps—depends on the size of your set. You can figure exactly, by the IR formula. Allow approximately 32 watts (at 120 volts) per quarter-amp tube or equivalent. Thus, 4 201A's and 1 112 equal 6 tubes, and take 192 watts. A 200-watt lamp will do the trick, the rheostat taking up the slack. Or use a 150-watt lamp and a 40-watt lamp in parallel, and dispense with rheostat and filament voltmeter altogether. I have not used mine in months.

The C voltage is taken off the IR drop of a resistance in the negative leg, next to the fuse plug. I use a burnt out heater unit for the resistance. It is adjusted to 5 ohms, and is shunted by a potentiometer, and a 4μfd. fixed condenser. This latter

may be low voltage and cheap. I use a 907 Dubilier and find it quite good enough. For several C voltages of varying values, which we always need, use several potentiometers. Since all the A and B current

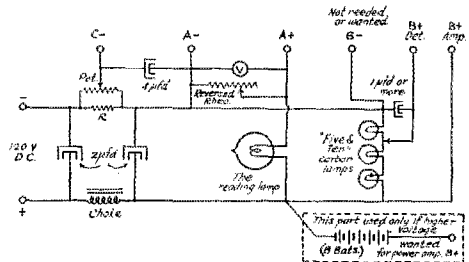

passes through this resistance, it is simple enough to design the C resistance for your own needs. In the above case, 1½ amps passing through 5 ohms give us an IR drop of 7½ volts. Your potentiometer takes what it wants of this. As Kruse brought out in his article on eliminators in Feb., 1926, QST, a mutual C voltage has a compensating effect on hum, since grid bucks plate.

If you want to use 171's, you will need more C bias—always at the expense of B voltage, remember. To get it, trim your heater element to the correct resistance. These heater elements can be bought new and entire on the sidewalk stores for 50 cents, and contain about 20 ohms of nichrome wire. As you trim C volts off B, you can build up B again by adding B battery blocks in series on the B end. Since this battery block is used, and only partially, for the last tube only, it makes a very economical arrangement. If you are a brave man and possess an electrician's license, go down in the cellar and get hold of the other side of the Edison three-wire system, with its 240 volts, for your higher B voltage on the last tube. This of course will require another filter system.

I have been using tubes a whole year with this hook-up which speaks well for voltage regulation. Occasionally we hear a hum, when their commutators get dirty or rough, but usually it is almost "pure d. c." Since you can get any voltage you want, up to 120, on the filament end, it makes a handy re-activator, if your thoughts run in that direction.

There is no minus B tap, this being taken

*663 Lexington Ave., New York City.

(Continued on Page 45)

Experimenters' Section Report

PROBLEM R-12, existing quiescently for so long on account of the limitations imposed on it by three electrode tubes, has, since the advent of the UX-222, bloomed forth in all its glory. Experimenters' Section Members have been quick to grasp the possibilities offered by the new tube and we are able to present the report and deductions of one of them—the ever-active Lidbury.

The UX-222 as a Short-Wave Amplifier

By F. A. Lidbury*

A NUMBER of measurements of voltage amplification with the UX-222 at frequencies between 3 and 18 megacycles has been carried out at this station. It is not believed that the method and detailed results would interest enough readers to warrant publication, but a discussion of the general results is likely to be of service to those who wish to use this tube as a short-wave amplifier. The tube with its associated plate circuit was of course thoroughly shielded, and all leads by-passed and choked; separate B batteries were also used. The method consisted in feeding the grid with an approximately constant voltage (about .25 volts) and measuring the output by a tube voltmeter. A tuning condenser of about 75 picofarads shunted the plug-in inductances in the plate circuit of the 222.

It is found that; (1), Amplifications of nearly 10 are obtainable in the 20-meter band and of over 20 in the 80-meter band, using ordinarily good receiver coils. (2), Quality of coils being equal, the amplification increases with the amount of inductance, and roughly as the square root of the inductance. (3), Most coils show an almost flat amplification factor over the tuning range of about 1 octave. (4), Improving the coil by the use of heavier wire than usual, properly spaced, and so on, increases the amplification factor; but a very considerable improvement in coil gives only a moderate improvement in amplification as compared with an ordinarily good coil. The use of a very poor coil, on the other hand, violently reduces the amplification. (5), Slightly higher amplifications are observed on a tube voltmeter using plate current characteristic (high negative bias) than on one using grid current characteristic, (grid leak to positive filament). The small difference will probably not compensate for the considerably greater sensitivity of the latter type of detector, in use.

As the measurements in question were done on a tube voltmeter, it is a question as to how far the results can be applied to an oscillating detector. Measurements, at least reliable ones, under such conditions would be much more difficult to carry out. How the impedance of the tuned circuit in the plate of the 222, looked at from that tube, would be affected, if at all, by setting the detector into which it feeds, and whose tuned grid circuit it constitutes, into oscillation, is an interesting subject of speculation on which it would be useful to get the opinions of some theoretical sharks. Insofar as the present results may apply to those conditions, the first clear conclusion would be to use as large an inductance and as small a tuning capacity as possible, both of course of the best possible quality. As usual there is an unfortunate inherent limit. There is a high plate-to-ground capacity in the 222; of the order of 15 picofarads. This is in shunt with the tuning condenser, so also

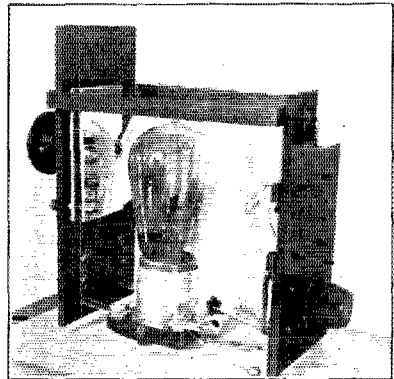

THE LATEST 5-METER LOW-POWER TRANSMITTER AT 8CMP, STATION OF DR. E. C. WOODRUFF, DIRECTOR, ATLANTIC DIVISION

In this view the tuned circuit may be seen. It consists of the tuning condenser on the farther support together with the single turn formed by the two copper strips connecting the uprights at the top. The end of the strips nearest the reader are connected by the micadon stopping condenser, to one side of which the plate supply is connected and from the other side of which the adjustable grid leak goes to filament. The plate and grid of the tube are connected across the variable condenser, thus giving the usual ultraudion circuit with excellent mechanical rigidity.

is the grid-filament capacity of the detector tube, and all the stray capacities of the wiring, sockets, bases, etc., between the plate of the 222 and the grid of the detector. All told, we have a minimum capacity of something like 25 picofarads, which is inherent in the circuit, and can be reduced very little

*8BAG, 33 Sugar St., Niagara Falls, N. Y.

by such devices as debasing the tube and paying very careful attention to stray capacities. It will be well, however, to select a tuning condenser with an extremely small minimum capacity, and build inductances so

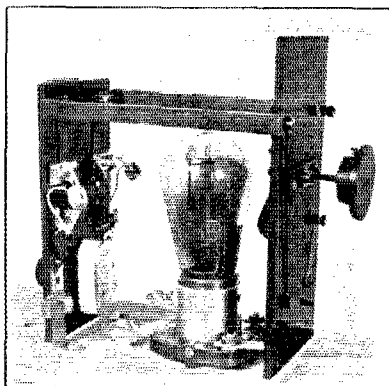

VIEW FROM OTHER END OF THE 8CM
5-METER TRANSMITTER

This view shows plate feed terminal and adjustable grid leak connections to the "stopping" end of the tuned circuit, also grid and filament connections to the "tuning" end on the nearer upright.

that they tune to the lowest desired wavelength with plates "all out". The maximum capacity of the condenser will be determined by the range desired, but at higher wavelengths a better amplification will be obtained by using a larger coil than by using the same coil with a large tuning condenser. The writer hazards the guess that much of the disappointment which has been expressed by amateurs who have tried without much success to use the tube as a short-wave amplifier is due to an improper L/C ratio; to too large C and much too small L.

While the coil should be as good as reasonably possible, over-fussiness in its construction will scarcely repay the trouble. A puzzling thing about the writer's measurements was the flat amplification frequency characteristic obtained on most coils. The answer became clear when one of his receiver coils was compared with; (a), a similar coil of much heavier wire (No. 12) and (b), one of much finer wire (No. 36). All these coils tuned from about 25 to 50 m. The receiver coil (No. 22 wire) gave a factor varying little from 11.5 over that range; the No. 12 wire had a factor of 14.5 at the highest wavelength, which *diminished* to 13 at the bottom; the No. 36 wire had a factor of only 2.6 at the top, and increased to 5 at 25 meters. This increase with frequency is what would ordinarily be expected from any given coil-condenser combination, if that combination were all that entered into the question, but the other capacities mentioned in the last paragraph enter into

the argument more and more as the value of the tuning condenser is reduced. The principal of these is the plate to shield-grid capacity of the amplifier tube, (with which can be lumped the grid-filament capacity of the detector). This is connected to the inductance through the tube lead-in wires, which are *not* the kind of material we should choose when we are trying to obtain a resistanceless resonant circuit! The more our tuning condenser is "out", the more of the circulating current is compelled to travel over these resistances, and this circumstance neutralizes the increased amplification one would expect with a given coil-condenser combination as one reduced the variable condenser with increase of frequency. (If your coil is so bad that its resistance is larger than that of the tube leads, you get the increased amplification with frequency; but in such cases of course the amplification is comparatively small.) The limitations imposed by this circumstance are likely to become so serious at waves much shorter than 20 meters as to render 222 amplification a practical impossibility, unless Kruse can persuade the R. C. A. to put out a line of tubes with nice fat silver lead-in wires, or something equally good!

Variable A-, B- and C- Power From D. C. Mains

(Continued from Page 43)

care of automatically. Also, no ground is needed on a receiver ordinarily using one. If you do use a ground, be sure and use a fixed condenser, say $\frac{1}{2}$ mike, in series.

Since we want all the inductance we can get in the choke, it will suggest itself to the experimenter to design a special choke in place of resistance R, for the C voltage. This would be killing several birds with one stone. Wind 3 pounds of No. 18 enameled wire on a laminated core $1\frac{1}{2}$ inches square. This should carry 2 amps without running too warm for comfort.

If you run a super het, and your reading lamp is too bright—a 10-tube set might take 320 watts—scatter the lights among several receptacles, always in parallel, of course. If you can't do this, and don't want so much light, use old fashioned carbon lamps.



A SHIELDED, CRYSTAL CONTROLLED UNIT

The Communications Department

F. E. Handy, Communications Manager
1711 Park St., Hartford, Conn.

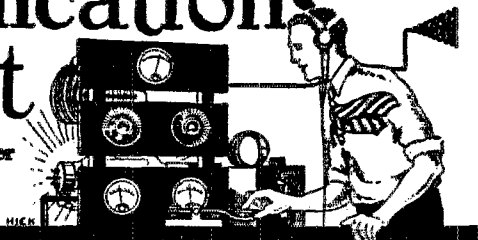

Ten O. R. S. Commandments

By John J. Hallahan*

- I. Thou shalt not forget to report to thy S.C.M. on the 26th day of each month.
- II. Thou shalt endeavor to arrange schedules and faithfully keep them.
- III. Thou shalt report these schedules to thy Route Manager each month.
- IV. Thou shalt place correct and complete address and date on each message.
- V. Thou shalt not permit messages to remain on thy hook over 48 hours.
- VI. Thou shalt not repeat each word twice unless requested to do so.
- VII. Thou shalt use directional CQ when thou hast traffic for QSR.
- VIII. Thou shalt keep a file of all messages for at least three months.
- IX. Thou shalt use no abbreviations in the text of thy messages.
- X. Thou shalt have a good wavemeter and clock in thy station at all times.

*2CP, RM No. N. J.

TRAFFIC BRIEFS

An "original" QSL card found its way in from 1AHV. It's one of the photographic type, and carries a small picture of the transmitter in the upper right corner and of the whole station in the lower left. Connecting these two pictures is a strip containing the call letters. In the upper left corner is a little guy with a big head who sez "Here's what is in my log, OM", and on the opposite corner is the top hunk of an ARRL log sheet, on which he writes the dope on your sigs. It's one of the "must be seen to be appreciated" kind.

Nc1AE has been keeping weekly sked with VCJ at Wakeham Bay, Hudson Straits, and was QSO with VCR at Nottingham Island, Hudson Straits, on 52.5 meters.

KDZ

naKDZ is the call of the present Wilkins Arctic Expedition. TABH reports working him, and says KDZ's sigs varied from R7 to 3, i.e., on 33.1 meters. TABH got the following message during the QSO: "Hr msg fm Fairbanks, Alaska, naKDZ, Mar. 1, 1928—This is the Wilkins Arctic Expedition at Fairbanks Alaska. Pse send word ARRL giving them dope on this contact. Capt. Wilkins arrived Fairbanks last Sunday night. We are testing radio before installing in airplane. It is installed at radio stn WXP. This is Geo. Jnaki operating nw. Pse tell rest of hams down there to listen for us. We vy anxious get reliable contacts arranged."

Operator Maki sends a radiogram from KDZ via 6UE suggesting that traffic for Fairbanks be routed via 6ARD.

Flash! The band between 9.99 and 10.71 meters (30,000-28,000 kc) has been opened to general amateur use by action of the Federal Radio Commission at the request of the A.R.R.L. Now to try 10-meters with some special types of antennas to get it to perform for the real long distance work!

Intelligence Tests for Amateurs

By John A. Bayles, 8AYA*

Question No. 1

8POP has a 5 watt and CQ's 586 times and does not raise a single station. Which of the following should he do? (1) Sell his set. (2) Put in a new grid leak. (3) Send out an SOS. (4) Start calling a few stations. (5) Write a hot letter to QST razzing everybody.

Question No. 2

STOT had a UX-210. He put 2000 volts on the plate. He has not been heard lately. Why not? Underline correct reason: (1) He is in jail. (2) He is putting in a 250 watt. (3) His UX-210 is deceased. (4) He got married. (5) His license expired.

Question No. 3

The BCL living next door to 8MAT has complained about 8MAT's key clicks spoiling his music. Which of the following should 8MAT do about it? (1) Tell the BCL to go to Hades. (2) Quit operating from seven to ten P.M. (3) Beat up the BCL. (4) Put in a keying filter. (5) Use compensated wave keying.

Question No. 4

9NUT had a good station. He worked all continents on 36 meters. Which of the following reasons explains why he isn't on the air? (1) He moved to Japan. (2) The Electric Co. turned off his juice because he wouldn't pay the bill. (3) He got tired of amateur radio. (4) His license was cancelled for operating off-wave. (5) His key broke down.

Question No. 5

A certain BCL is tired of listening to: "This is the --- hour, sent to you through the courtesy of the --- Co., makers of ---. The orchestra will now play ---, etc., etc." He wants to get into the ham game and realizes he will have to learn a lot before he can get a license. What is he going to do about it? Underline the sentence which explains correctly: (1) Read the *Saturday Evening Post*. (2) Go to college. (3) Subscribe to QST and get a copy of *The Radio Amateur's Handbook*. (4) Buy a copy of *Radio News*. (5) Ask some hard-boiled ham to help him.

Question No. 6

STAP has a 250-watt crystal-controlled set and a Vibroplex. He doesn't seem to get out so well though. One of the following reasons explains correctly why he doesn't. Which one is it? (1) Other stations don't like his call. (2) He has halitosis. (3) His sending is too fast. (4) His sending is too slow. (5) He is never on the air.

*822 Laurel St., Cincinnati, Ohio.

GMD

The Dyott Brazil Expedition has been out for nearly a month. The base station (two 203A's in self rectified Hartley circuit, 1000 volts, 400 cycle plate supply) is expected to be on the air by April 1. During March traffic for the U.S.A. has been coming through fine by amateur radio, 8BIB and 8CFR are to be congratulated on their fine work. All amateurs are requested to be on the lookout for GMD's signals and traffic. In addition to the base station a field transmitter consisting of two UX-210's in a T.P.T.G. circuit with 500 volts B-battery supply will be used for contact with the base sta-

tion. Messages will be sent in semi-code form and addressed to ALLIANCE NEW YORK. Amateurs should copy and forward these messages to the North American Newspaper Alliance, 63 Park Row, New York City. Amateur cooperation will be greatly appreciated.

GMD will work on the following schedules: Daylight, 20.5 meters between 2 and 5 PM EST. Night, 36.6 meters between 7 and 9 PM EST and midnight to five AM EST. Get busy and do your part with GMD, OM.

WNP

WNP (Reed via 1FL and 1MK) nr. 468, March 9 To A.R.R.L., Hartford, Conn. We are back on twenty meters. This band will be used exclusively until the Bowdoin sails for home next September. Longer days and shorter nights have killed eighty meter signals but the twenty meter band is again quite reliable. February was a period of stormy weather and bad signals. Eighty meters dropped out and twenty meters was still very erratic. The following stations helped greatly in moving our traffic when regular schedules were not running smoothly: 2VI, 3QP, 8AHC, 8BEN, 9EFH, nclCO. Three stations broke through to us with voice on twenty meter band. ISZ's new crystal controlled tone was the first worked followed by 8BEN and 1SW. We had many interesting QSO's with 2VI while arranging a special program broadcast to WNP through WEAF, WGY and chain stations. Had nice chat with op3AA at 1MX one afternoon. It was also mighty interesting to QSO 9EZ with "DN" of old 9ZN at the key. Later "WR" of this same 9EZ handed us some news of the passing of WSA and WPA two husky commercial sparks into hands of RCA to be converted into tube outfits. Wish few more of you commercial fellows would slip along a word now and then about what's happening on 600 meters. 1FL continues to take a great deal of our traffic. He is easily our most reliable contact. All messages for us in future should be routed via 1FL, ISZ, 1XM, 9AFA, or 9EFH these all reliable contacts.

Messages handled February sent 214, Received 135, Total 349 Stop Rest regards.

"WNP NR 415 March 8 via 9EFH.

Calls worked in February: Twenty meters: lacm 1ajz 1alj laxx layn lbat lber lbi1 lbyr lby lbyv led lcmd lcom lfl lia lih lmx lmy lsw lsz luo lxm lxy 2afy 2aon 2api 2bge 2sb 2ol 2vi 3akw 3nr 3sk 4bl 8abx 8abc 8akv 8arb 8asf 8bet 8ben 8bud 8cdl 8cer 8ecs 8ej 8eky 8evj 8dju 8dkl 8dl1 8mq 8nb 8rc 9afa 9bgu 9btv 9dyf 9dzm 9efh 9efz 9ez nclbd nclco eg6ab eb4au eb4eb ec3a2 ef8d fo3z; eighty meters, laac lasi lfl lxy 2akq 3qp 9afa ne8ae."

--Cliff Himoc.

1MK

The A.R.R.L. Headquarters station has been moved from its old location at 1711 Park St., Hartford, to a much better location for reception and transmission at Brainard Field, Hartford. The evolution of our present station has been slow but progress has been made steadily from the time when five watters were installed to pick up traffic bound for Headquarters which found its way to the shacks of Connecticut amateurs. Suffice it to say that the station is at last freed of the handicaps offered by a poor location in a business and residential district and by inadequate space for a suitable installation. New equipment has been added so that 1MK is now able to serve A.R.R.L. members in every way that a station can be of service.

Telephone facilities connect the station with the Headquarters offices. Two transmitters working on different frequencies may be used separately or simultaneously. The main transmitter is a 500-watt T.P.T.G. set which may be tuned to any desired points in the 20-, 40-, or 80-meter bands. An auxiliary 250-watt Hartley arrangement is available at the throw of a switch for 40-meter work. This will be used with the main set on 80-meters for simultaneous transmission of the Official Broadcast to A.R.R.L. Members on two bands. The two transmitters are provided separately with mercury-arc and motor-generator power supplies but provision has been made for working both transmitters from one power supply in case of necessity. The new installation is in every respect a "real" station without the disadvantages of its predecessors.

1MK will be found on 83.86 meters (3575 kc) whenever working in the 80-meter band . . . and on 41.93

meters (7150 kc) when working in the 40-meter band. A definite frequency will be announced for 20-meter operation in the near future together with a complete list of scheduled points through which you may route messages to Headquarters if you do not shoot them in direct to 1MK.

A precision wavemeter is located at the station so that 1MK will always be found right on the given point selected for work in the different amateur bands. The frequency will be changed a small amount to get around severe interference if necessary but will always be returned promptly to the wavelengths stated at the end of such a transmission. A convenient oscillator is provided for use with the wavemeter in measuring the wavelength of stations worked when this is expressly requested during communication or by special mail arrangement (schedule). An accuracy of within 1/4 of one per cent (20 kc at 40-meters, 10 kc at 80-meters) may be expected of wavemeter readings.

Mr. R. B. Parmeter of 9WR-90X is Chief Op. at the new 1MK. Bob signs "RP" as some of you will remember from the days when he started to build a reputation with a 1/2 K.W. spark set at Knoxville, Ill. "RP" hails from Louisville, Ky. You will find him ready for any traffic you have for Headquarters or for QSR.

The country will be covered as completely as possible with schedules for placing and collecting traffic in addition to a rather heavy program of general operation which will be outlined briefly herewith. In addition to this plan of operation other general operating shifts will be kept by "AH", "HJD", "LJ" and "PH" when possible. The station particularly invites messages for any individual or department at Headquarters. It is requested that inquiries of the Technical Department or Circulation Department always be accompanied with as complete an address as possible regardless of whether the message is taken direct or relayed to facilitate replies.

Broadcast messages to A.R.R.L. Members are sent on both 40- and 80-meter wavelengths at the time indicated. The quota of schedules which will occupy the scheduled periods is nearly filled but a few more schedules with reliable stations at suitable points will be added. At present there are more 40-meter scheduled periods open than those set aside for 80-meter work.

1MK OPERATION (Eastern Standard Time)

Sunday:

- 7 p.m. to 8 p.m. 80-meter schedules
- 8 p.m. BC to A.R.R.L. Members on 83.86 and 41.93 meters
- 8.10 p.m. to 9 p.m. 80-meter "general" operation
- 9 p.m. to 10 p.m. 40-meter schedules
- 10 p.m. to 11 p.m. 40-meter "general" operation
- 11 p.m. to midnight 80-meter schedules
- Midnight BC to A.R.R.L. Members on 83.86 and 41.93 meters
- 12.10 a.m. to 1 a.m. 80-meter "general" operation

Monday and Friday:

- 7 p.m. to 8 p.m. 80-meter schedules
- 8 p.m. BC to A.R.R.L. Members on 83.86 and 41.93 meters
- 8.10 p.m. to 9 p.m. 80-meter "general" operation
- 9 p.m. to 10 p.m. 80-meter schedules
- 10 p.m. to 11 p.m. 80-meter "general" operation
- 11 p.m. to midnight 80-meter schedules
- Midnight BC to A.R.R.L. Members on 83.86 and 41.93 meters
- 12.10 a.m. to 1 a.m. 40-meter "general" operation

Tuesday and Thursday:

- 7 p.m. to 8 p.m. 80-meter schedules
- 8 p.m. BC to A.R.R.L. Members on 83.86 and 41.93 meters
- 8.10 p.m. to 9 p.m. 80-meter "general" operation
- 9 p.m. to 10 p.m. 80-meter schedules
- 10 p.m. to 11 p.m. 80-meter "general" operation
- 11 p.m. to midnight 80-meter schedules
- Midnight BC to A.R.R.L. Members on 83.86 and 41.93 meters

A.R.R.L. Members everywhere should be able to copy the broadcasts direct. Any special subject of immediate interest to Members will be addressed to them through 1MK on the regular BC schedules given above. Official Broadcasting Stations will copy this information direct from Headquarters by radio (instead of mail) and repeat the broadcasts whenever possible.

Whenever you want to QSO A.R.R.L. Headquarters look for 1MK on 83.86 or 41.93 meters in the "general" operating periods and give us a call.

BRASS POUNDERS' LEAGUE

| Call | Orig. | Del. | Rel. | Total |
|--------|-------|------|------|-------|
| 9AIN | 64 | 33 | 668 | 765 |
| op1HR | 232 | 177 | 360 | 719 |
| 8BMJ | 230 | 32 | 402 | 714 |
| 9AMA | 1 | 2 | 698 | 701 |
| 8CYK | 102 | 26 | 563 | 691 |
| 9DRA | 32 | 70 | 402 | 504 |
| 1FL | 83 | 72 | 346 | 501 |
| 8DBM | 46 | 366 | 62 | 474 |
| 3AKB | 38 | 60 | 343 | 441 |
| 3QP | 81 | 50 | 277 | 408 |
| 9DLD | 21 | 53 | 334 | 408 |
| 8VZ | 119 | 48 | 240 | 407 |
| 7AEC | 18 | 88 | 258 | 364 |
| 1AKS | 146 | 3 | 202 | 351 |
| 9EJQ | 36 | 27 | 281 | 344 |
| 1CRA | 78 | 40 | 217 | 335 |
| 9DAE | 45 | 5 | 280 | 330 |
| 8EU | 27 | 40 | 260 | 327 |
| 9BTK | 4 | 3 | 316 | 323 |
| 8DED | 31 | 52 | 238 | 321 |
| 6AMM* | 107 | 150 | 43 | 300 |
| 9DZW | 19 | 13 | 266 | 298 |
| 9BKV | 44 | 13 | 232 | 289 |
| 9EAM | 5 | 57 | 222 | 284 |
| 9CZC | 3 | 10 | 272 | 285 |
| 8DAQ | 20 | 282 | 26 | 274 |
| 1AZD | 58 | 80 | 133 | 266 |
| 1VB | 2 | 9 | 254 | 265 |
| 8BYN | 51 | 20 | 193 | 264 |
| 9DTK | 84 | 47 | 132 | 263 |
| 2CF | 69 | 58 | 136 | 263 |
| 9CUX | 13 | 26 | 220 | 259 |
| 5AMO | 38 | 70 | 136 | 244 |
| 8DHL | 43 | 17 | 173 | 233 |
| 9BJL | 1 | 3 | 223 | 232 |
| 8GI | 14 | 26 | 183 | 228 |
| 9DEA | 28 | 8 | 192 | 228 |
| 9EZ | 36 | 70 | 72 | 228 |
| 8BAU | 46 | 35 | 144 | 225 |
| 9EBO | 132 | 28 | 60 | 220 |
| 8DBM | 18 | 22 | 180 | 220 |
| 6BXI | 18 | 2 | 196 | 216 |
| 9PB | 4 | 28 | 184 | 216 |
| 9DGW | 3 | 9 | 202 | 214 |
| 9EK-XH | 109 | 103 | 2 | 214 |
| 3ADE | 32 | 14 | 168 | 214 |
| 9RR | 20 | 10 | 178 | 208 |
| 9AMO | 10 | 19 | 176 | 205 |
| 1CTI | 46 | 39 | 119 | 204 |
| 1BIG | 106 | 97 | — | 203 |
| 8RN | 62 | 37 | 104 | 203 |
| 1LM | 72 | 52 | 74 | 198 |
| 1VW | 77 | 91 | 28 | 196 |
| 8CDC | 44 | 51 | 97 | 192 |
| 9DNG | 97 | 69 | 9 | 175 |
| 9BZO | 17 | 76 | 76 | 169 |
| 1IP | 34 | 50 | 84 | 168 |
| 9CMV | 56 | 54 | 51 | 161 |
| 1BNS | 43 | 53 | 52 | 148 |
| 9CBT | 28 | 32 | 68 | 146 |
| op1DL | 58 | 62 | 24 | 144 |
| 1KY | 38 | 57 | 40 | 135 |
| 6AM | 71 | 55 | 2 | 128 |
| 6EC | 48 | 67 | 10 | 125 |
| 9DKG | 58 | 56 | 6 | 120 |
| 6BSN | 16 | 64 | 41 | 115 |
| 1AXA | 62 | 52 | — | 114 |
| 9ABM | 4 | 76 | 32 | 112 |
| 9ENU | 38 | 51 | 12 | 101 |
| 1ASD | 5 | 54 | 26 | 85 |
| 1KH | 4 | 53 | 4 | 61 |

The honors this month go to 9AIN and op1HR!

*6AMM should have been listed in the RPL last month. His totals were 36, 66, 20, 122. Also Feb. and March QST should have listed op1HR, op1DR and op1DL in the RPL. November: op1HR 150, 126, 318, 598; 1DR, 110, 12, 240, 862; 1DL, 57, 71, 8, 136. December: 1HR, 192, 170, 302, 664; 1DR, 84, 28, 220, 332; 1DL, 66, 84, 18, 168.

TRAFFIC BRIEFS

When you have traffic for the Philippines, give it to either 6AJM or 6AMM. They both have daily skeds with the Islands, and will get it over there in a hurry. 6AJM's sked is with op1AD, and 6AMM's is with op1HR.

You'll be interested in this message that op 1AD sent nu 6AJM: "Have just rec'd card from an under-cover ham in Japan. He advises that aj JMPB and aj JLZB are not amateurs but Japanese detective stations interested only in getting the QRAs of, under-cover hams. Suggest that you inform all hams possible and QST. Also suggest boycott of these two stations.—(sig.) op 1AD."

The Boy Scout Radio Exhibit held in Buffalo some time ago was a complete success. Lots of interest was stimulated in the League and its work, and a total of 275 messages were collected. These were cleared through the cooperation of 8ADE and 8CYK. The demonstration aided in proving to the Scout Council the importance of the amateur, and plans are being promoted by 8TH, who sends us this report, to introduce transmitters into the Scout Troops. *Boys Life*, the official Scout Organ, will include a story of the exhibit in its radio section.

During the recent fire at Fall River, Mass., 1PE, 1ACH, 1BUB, 1BKQ, and 1ASR were on the air from one to three A. M., ready to help in any way possible. From time to time these stations called Fall River, but received no reply. 1ASR and 1BKQ kept watch for a time, but observed no QRR signals, and signed off at three A. M.

Didja know that British amateurs hold a QSO party on 80 meters every Monday evening? They say that many "nu" stations come in FB on that wave, and want more of us to keep our ears open for 'em. 1FL worked eg2NH the other night, getting an R7. 2NH was coming through about R4 on 83 meters.

6CCT's entry card in the International Contest was really different. You see Walt is a member of the Telephoto Staff of the Pacific Tel. and Tel. Co., in San Francisco. So he took a piece of paper, printed 6CCT in nice big letters, typed out his application for entry, and then had a picture of the improvised QSL card transmitted over the wires of the Bell System to the Boston office of the American Tel. and Tel. Co., where it was developed and mailed down to us. The man on the Boston end of things was ex 1CHF, who sez he'll probably return to the air in about a month with something more than the spark coil he had in pre-broadcasting days.

An interesting little item which appeared in the Northern States Power Co.'s Safety Service Magazine says in part: "On the night of February 7 a bad sleet storm visited the Pipestone District, doing considerable damage to the distribution systems of the various towns, interrupting service, and destroying all communications by telephone and telegraph. 9BN, of Minneapolis, succeeded in getting in touch with 9CAJ, of Pipestone, and arrangements were made for sending material and a crew of men down to help restore service. This is a striking example of the value of the American Radio Relay League, and is likely to result in the forming of a Northern States Power Radio Transmitting Club."

The *Daily Argus Leader* of Sioux Falls, S. D., carries another story of the same emergency. 9DES, of Sioux Falls, together with the other hams of that city, worked long and hard to get into contact with 9CAJ at Pipestone, Minn. From 1.45 P. M. until Midnight, all hands worked fast and furiously. 9DES was doing most of the operating, handling in all over 40 messages for the Power Co., and the other boys were doing the delivering. 9DWN at Pierre did his share in relaying a lot of DES's messages. FB work,—all of you!

DIVISIONAL REPORTS

ATLANTIC DIVISION

MARYLAND-DELAWARE-DIST. OF COLUMBIA—SCM, H. H. Layton, 3AIS—Delaware: The in this state is nearly 100% Naval Reserve with exception of 3ALQ and 3SL. 3AJH is now on 80 meters and thinks it FB. 3ALQ is not on

much lately. 3AED is heard in nearly all countries. 3WJ rattles the cans of the west coast gang with his new Xtal set on 38.52 meters. 3AIS is on the air with a 50 since his 250 went west. 3AUN is coming back on the air with one of 3ZO's 250 watt bottles. FB. 3AOP is a newcomer in our ranks.

Maryland: 3CFX at St. Michaels came through with his report by letter saying that he is keeping a sked with 3KU and 3ZI but complains of no traffic his way. 3BBW reports that due to tube trouble he has not been on the air for nearly a month but is now going strong with two five tube watters.

Dist. of Columbia: We are all sorry to hear that 3CAB has signed off indefinitely and has turned in his ORS certificate. 3APX has made application for ORS.

Traffic: 3ALQ 1, 3SL 4, 3AJH 8, 3AED 4, 3WJ 3, 3AIS 9, 3BBW 6, 3APX 30.

SOUTHERN NEW JERSEY—Acting SCM, E. G. Raser, 3ZI—3CFG was hampered by the Tests but turned in a good total just the same. 3BSD lost his 50 watter and his zip that was the pride of his heart. 3AOC is a new station at P. U. operated by several 2nd dist. amateurs, and is doing consistent work on schedules. 3KJ reported but still keeps on the inactive list. 3CO expects to be on with remote control very soon. 3SJ over in Finerne is trying for a commercial ticket. 3AYI will be too busy to come in on the active list but hopes to be able to later in the season. We have a new ORS prospect in 3AMI at Merchantville, N. J. 3CBX is going to operate in the National Guard, Field Artillery Unit, just forming in Trenton. 3ZI is still hard at it with sked and RM-SCM duties.

Traffic: 3ZI 171, 3CFG 135, 3AOC 43, 3SJ 25.

EASTERN PENNSYLVANIA—Acting SCM, E. L. Maneval, 3EU—3AKB has plenty of QRKS from BCLs. 3QP is sure well skedded. 3EU reports financial QRM. 3ADE will soon be an ORS. 3CGZ is a hopeful chap. 3ANK ran out of ink on his report card. 3NF reported by radio. 3QR is trying new skeds. 3VF is taking a week off to build a new receiver. 3WJ wants an ORS. 3QM announces the arrival of a brand new YL op. 3AFJ is in and out of town. 3HH did some clever routing in the tests. 3LC wants the opinion on a receiver to cover 40 and 80 in one lick. 3BMS blew his 50 in the tests but has an 852. 3DHT is a new boy in Scranton. 3BQP and the new OW are having a great time house hunting. 3BFL better get 3AVK and start a company. 3AVL another in the same boat. 3CDS wants skeds when its time for the milkman. Hi. 3AWT is going downhill but can't be helped. 3ADQ—try a want ad in QST, Rex! 3BYZ wants to move his 83 foot stick—don't all speak at once.

Traffic: 3EU 227, 3AWT 6, 3CDS 7, 3AVL 8, 3HFL 10, 3BQP 11, 3DHT 11, 3BMS 11, 3LC 20, 3HH 22, 3AFJ 27, 3WJ 78, 3VF 107, 3QR 112, 3NF 128, 3AVK 130, 3CGZ 168, 3ADE 214, 3QP 408, 3AKB 441.

WESTERN PENNSYLVANIA—SCM, G. L. Crossley, 3XE—3DRU's rectifier froze. 3VF is recuperating from sickness. 3AOS, 3CQJ, 3CXQ are selling sets to BCLs. 3CZE is QRW at school. 3CAE is running an 852. 3BHN worked a 9 on phone. 3BHN has succeeded in working a 6. 3ARC is using a pair of 281s as rectifiers as well as a chemical rectifier. 3GI reports using a 281 as a rectifier. 3CUG has a 20 meter schedule with a Brazilian station. 3CYF is using a 112A tube in his transmitter. 3AMU tried his set on 20 meters using the 3rd harmonic, and worked Belgium R7. 3ABW has a pair of 211s but he says ND. 3BGW is on the air some, handling a little traffic. 3AJU is on 40 and handles traffic. 3BRM has been sick for the last 11 weeks. 3EW has a sync on 40 meters. 3CEO is using a 222 in his xmitter. 3AXM is at Radio School. 3CKP is trying 40 with some success. 3AKI has several schedules—he has been sick for a few weeks. 3VE has been having transmitter trouble. 3CFR found his antenna down 2 hrs before the tests but he had it up in time. 3AGO is QRW because he is to be a benedict soon. 3CES has a new master oscillator on 20. 3DOQ has been handling his share of the traffic. 3XE and the gang are QRW with convention work.

Traffic: 3GI 228, 3DOQ 177, 3XE 89, 3AKI 86, 3AMU 63, 3CEO 59, 3EW 58, 3BRM 31, 3VE 26, 3CFR 26, 3CUG 25, 3AJU 15, 3DKS 12, 3CYF 8, 3AGO 5, 3ARC 5, 3BGW 5, 3ABW 3, 3CES 2.

WESTERN NEW YORK—SCM, C. S. Taylor, 3PJ—3ABX joined the Army net this month. 3AHC made the BPL. 3AKZ worked NL-GREN. 3ALB has managed to get in some traffic. 3AYU has increased his schedules. 3BCM is punching through much better now. 3RFG worked Africa and some other foreigners. 3BIW was a little timid on account of key clicks to BCL. 3BMJ has had a busy month handling over 700 msgs from Boy Scout meet-

ings. 3BQK has been away so traffic was slight. 3BUP wants schedules with eastern and southern stations. 3BZP reports his arm still out of commission. 3CDB made the BPL this month but blew his 210s. 3CDC worked Tasmania and Panama with 7 watts input. 3CPC worked 6th dist. and Canada, with his new 20 meter station. 3CNX's left him, so he is using a 50 watter now. 3CRC says Syracuse is alive once again with North High School and Nottingham H. S. building short wave xmitters. 3AXA is now using an 852. 3CLL, 3HX, 3BAL are now very active. 3CRC has been hearing many foreigners. 3BIN is heard now and then. 3AWP, ex 3DKE is now operating at WFBL. 3AWP is the cause of WFBL and 3AGO and 3XH are Tech. Engineers of WSYR. 3CRF has been heard in England. 3CSW, 3CPC and 3AYB paid the SCM a visit while in Buffalo. 3CVJ has many schedules and traffic. 3CYK still continues to keep many schedules. 3DXX says traffic took an awful flop due to his working DX. 3DME won the Fourth Prize in Army-Amateur Contest. 3DQP is a real DX and traffic hound now. 3DRJ's crystal went west. The transformer blew and also the filter quit. 3DSP has new Esco motor generator on the way. 3PI handled traffic with fo-A8V, eg-5ML and xnu-JJ. 3TH is again interesting the Boy Scouts in the A. R. R. L. and handling traffic and schedules. 3BLI is rebuilding his xmitter. 3AVW has been heard in Germany.

Traffic: 3ABX 4, 3AHC 151, 3AKZ 6, 3ALB 32, 3AYU 48, 3RCM 33, 3BFG 26, 3BIW 18, 3BMJ 714, 3BQK 2, 3BUP 11, 3CDB 176, 3CDC 192, 3CPC 37, 3CNX 94, 3CVJ 22, 3CYK 691, 3DXX 23, 3DME 54, 3DQP 15, 3DRJ 46, 3DSP 216, 3PJ 88, 3PJ 7, 3TH 21, 3BLI 2.

CENTRAL DIVISION

OHIO—SCM, H. C. Storek, 3BYN—3DIH, 3BAU, 3DBM, and 3RN made the BPL. 3BAU has organized a small club among the north end gang in Columbus and they have a station going under the call of 3DDZ. 3DIH has been busy rebuilding 3DDQ. 3DBM gave his total via the air route. 3RN blew his H tube and is now on with a UX210. 3GZ got 253 points in the tests, but also got 155 msgs besides. 3ALU, the RM, wants every ORS to originate at least 50 msgs. each month. 3BAS is still doing good work along traffic lines, altho he doesn't want to tie himself down with an ORS. 3CFL said too busy with tests to have a big total. 3CNO is right up with the top-notchers. 3DDK is also coming right along with traffic and is making a good ORS. 3DSY traded his xtal for a 50 watter as he hasn't enough power for xtal amplifier. 3BOR lost his plate transformer, blew his 210 and ruined his S tubes. 3CMB blew his 250. 3JB says he will have more traffic next month. 3CXD, a new ORS, wants traffic and is on very consistently. 3BEA says all good ops are getting lazy and unreliable, and traffic getting scarcer right along. 3AKO expects to be out at 8HB again about the middle of March. 3DJV has been handling some traffic for WNP. 3DNL reports activities at 3DDZ. 3CBI wrecked his mercury arc and is now on with chemical again until arc comes back. 3BAC bought a bug, and is very proud of it. 3AVP reports working xnu-MD, an unlicensed freighter in Gulf of Panama. 3CAU reports but says nothing. 3AQU has been having trouble with BCLs and has to fix things with the RI before he can be on the air again. 3BKM sure is busy. 3SI and 3ALW have nothing to say. 3BAH is back on the air with two 210s and going fine. 3AZO has another plate transformer and will be on air FB soon. 3DHS is working an 852 on 20 meters. 3OQ was much discouraged this month but hopes for better next. 3PL blew a 50 watter, cracked a xtal, got tangled up with 2000 volts of RAC and put himself on the bum. 3DIA is following in the SCMs footsteps in blowing filter condensers. Hi. 3ARK blew every tube in sight, and then dug up an old 201A, put 10 volts on the filament and 1000 volts on the plate, worked it that way until it blew, and then gave up. 3AWK expects to change QRA. 3BKQ has been experimenting too much to get traffic. 3RRH is building a new set at last. Hi. 3CTD worked WNP on 20 meters. 3DQZ is QRW school. 3ALU's plan of all originating more traffic is good, tho the total is high.

Traffic: 3BYN 264, 3DIH 233, 3BAU 225, 3DBM 220, 3RN 203, 3GZ 155, 3ALU 152, 3BAS 102, 3CFL 101, 3CNO 95, 3DDK 85, 3DSY 62, 3BOR 54, 3CMB 52, 3JB 41, 3CXD 41, 3HFA 41, 3AKO 41, 3DJV 35, 3DNL 35, 3CBI 25, 3RAC 24, 3AVB 18, 3CAU 17, 3AQU 17, 3BKM 13, 3SI 11, 3ALW 9, 3BAH 7, 3AZO 5, 3DHS 3, 3OQ 3, 3PL 3, 3DIA 2.

MICHIGAN—SCM, Dallas Wise, 8CEP—9EAY is putting in an all wave transmitter. 8DKX was quite active in the international tests. 8AUB says he will have more time to work the set now that they have decided not to hold the convention in Grand Rapids. 8DAQ has been going great and handled one 67 word message from WNP. 8AAF has been working in the 80 meter band and has a 50 watt on the way. 8AJL reports using 600 volts on his 201As and says they are working out good. 8CKZ will have a 150 meter fone set ready soon. 8RE keeps his bi-weekly schedule with su-2AK at Tela Honduras. 8DED has fifteen schedules per week and you can hear him most any time. 8VK is back on the air with a good kick and ready for all the traffic you can hand him. 8BRS reports trouble with filter condensers on 20 meters so is going back to 40. 8AMS is working 40 when he can find time between jobs. 9CSI has his xtal job completed working on 41.6. 8ACU reports nothing doing on the tests. 8DIV had the same trouble and is going back to 40 and 80. 9AYR was troubled with power leaks but has been trying fone with 9EGG. 8ZF has just started work on 80 meters. 8KN was not very active due to most of the ops working 8ZF. 8DSF is still using spark coil for plate supply. 8NQ will operate another station at New Baltimore soon. 9CEX handled a few during February. 8BCI is moving to Ada, Ohio. 8CAT has a chemical rectifier on the job now. 8CU of "Cherry Tree Farm" foned in that he is back on the air again and going strong. 8BRV and 8DFO have been busy working on a new receiver using the UX222.

Traffic: 8CHT 18, 9EAY 17, 8DKX 24, 8AUV 36, 8DAQ 274, 8AAF 56, 8AJL 29, 8CKZ 17, 8RE 15, 8DED 321, 8VK 132, 8BRS 4, 9CSI 17, 8ACU 3, 8ZF 51, 9CEX 20, 8DSF 151, 8NQ 18, 8BCI 35, 8CAT 8, 8ZZ 12, 8CEP 23.

INDIANA—SCM, D. J. Angus, 9CYQ—9EZ, the station at Culver Military Academy is now an ORS and going big. 9EVA reports fine work on 20. 9AIN the banner traffic station of Indiana does it with schedules and plenty of time. 9AEB after 8 years of faithful work has at last worked his first 7. 9AGW says that borax in his rectifier makes his sigs more penetrating. 9DXH is back on the air again. 9CVX is using a 222 in receiver and reports FB. 9QS wants schedules as he is back on again. 9FQ is doing some very fine traffic work. 9ETV is a new station at Nappanee. 9EHI is coming back on the air with a 250. 9EXW (ex Army) has started up with 40 meters. 9EF entertained 9 of the Chicago gang a few days ago. 9ESH is very active at Michawaka on 80. 9DBJ is going to join the navy. 9CLO has 5 crystals so he can QSY. 9CMV lost their 500 and their 50 watt transmitters. 9DUZ, RM, has resigned and R. O. Ellis, 9ASK at South Bend, was elected to take his place at a meeting of the hams of South Bend, Michawaka and Elkhart. 9ASX is now route manager for northwestern Indiana.

Traffic: 9AIN 765, 9EZ 228, 9CMV 161, 9CBT 146, 9CRV 141, 9FQ 95, 9DBA 67, 9CYQ 31, 9CLO 30, 9BCM 26, 9EF 25, 9DBJ 23, 9EGE 21, 9DPV 18, 9DHJ 18, 9BYI 18, 9BZZ 12, 9ASX 10, 9QS 10, 9RS 9, 9CVX 8, 9APG 7, 9DWE 6, 9DXH 5, 9CSP 4, 9AGW 4, 9AEB 2, 9EVA 9, 9CSC 2.

WISCONSIN—SCM, C. N. Crapo, 9VD—9DLD keeps on climbing due to remarkable cooperation from the stations he is linked up with. 9DTK says his old tube is getting feeble and shaky but the gang still send in R9s. 9EBO believes in publicity and because of this originate a lot of msgs. 9EK-XH says the new Burgess engineering circular No. 15 on Airplane Radio Apparatus is ready for distribution and will be sent to those asking for it. 9CDT will soon be in the RPL. 9DLQ is still going strong but says 40 meters is pretty crowded. 9CCK is on the job 5 days a week on 7200 kc. 9DEK is keeping three schedules on 82 meters and wants an ORS. 9CYU didn't want to be left out so reported via Western Union. 9ABM is waiting for the next Milwaukee QSO party. 9BPW was sick for two weeks which lowered his traffic total. 9EEF works on 42 and thinks traffic is best there. 9DJK sent in his first report of 55 msgs. 9ESM has rebuilt his transmitter and says its working fine now. 9ARE is going to Dodge Institute at Valparaiso. 9DND has schedules with 9DLQ. 9EMD is on the job again with two schedules on 80 meters. 9SO has been busy with tests and worked oo-1AJ at Polynesia. 9AZN reported via 9DTE. 9AZY had tough luck this month and blew his fifty watt. 9EWY reports for the first time via 9DTE. 9BWO says he is fooling around with a converter on 80 meters. 9ASL tells me that he has the original bay-wire outfit. 9CJU has schedules with 9ABM Tuesdays and Saturdays. 9COI reports that

the Madison Club had its transmitter at the Madison Radio Show and transmitted messages which made quite a hit. 9CIB now 9EYU has his 852 working on 20 and 40. 9EHM had trouble with landlord on account of his transmitter and is moving. 9EQP is a new station at Milwaukee using a 201A on low power. 9CVI working on 20 and mostly Saturday afternoons. 9DCX says its 40 below in Chippewa and still the plate gets red. HI. 9AFZ has been on the 15 mc band lately and hears lots of fones there. 9BIB tried hard during the tests but no luck. 9CFT worked three OAs one morning. 9EQL says not doing much but wants some schedules. 9DZZ sent in a report for the first time to help us out. 9BJY not doing anything, rectifier on the blink.

Traffic: 9DLD 408, 9DTK 263, 9EBO 220, 9EK-XH 214, 9CDT 171, 9DLQ 145, 9CCK 124, 9DEK 114, 9CYU 114, 9ABM 112, 9BPW 87, 9EEF 78, 9DJK 55, 9ESM 53, 9ARE 45, 9DND 35, 9SO 27, 9EMD 30, 9AZY 25, 9BWO 17, 9CJU 20, 9COI 11, 9EYU 10, 9EHM 10, 9EQP 7, 9CVI 7, 9DCX 7, 9AZN 25, 9EWY 20, 9ASL 17, 9EVE 7, 9AFZ 7, 9BIB 4, 9ELD 4, 9CFT 3, 9EQL 2, 9DZZ 2, 9BJY 1.

KENTUCKY—SCM, D. A. Downard, 9ARU—The Louisville, Ky., New Albany and Jeffersonville, Ind. hams celebrated the departure of 9WR for Hartford, Conn. where he will be one of the ops at new 1MK, with an all night hamfest after which an inspection trip to WYW, the Army station at Bowman Field, was made during the wee small hours. After his hand came in contact with the antenna lead-in to the set at WYW, a certain ham in Jeffersonville says, "Them ain't blisters—just black paint from painting my mast". HI. 9EYW is a promising new station. 9BAZ has an arc perking. 9MN is sporting a new UX222 in his receiver and says it eliminates power leak QRM 9BAN works Mexico in Spanish. HI. 9ENR celebrated Washington's birthday by working his first "six". 9RGA is in the air on 40. 9AID is QRW with a new job and doesn't get a lot of time for brass pounding. 9OX says he is on spasmodically. 9BWJ is getting back in shape after losing his mast and tonsils. 9ARU is working everything he hears on 40 meters. 9DDH has a new TG-TP transmitter. 9DLU is getting out OK with his breadboard transmitter. 9DQC is on 80 with an 852 and sync rectifier.

Traffic: 9OX 98, 9BAZ 52, 9MN 24, 9BAN 22, 9ENR 9, 9ARU 8, 9BEH 4, 9RGA 3, 9AID 2.

ILLINOIS—SCM, W. F. Schweitzer, 9AAW—This reporting month includes the traffic reports of 71 stations. The last reported call issued was 9FCD. At a meeting of the CRTA traffic cup committee they decided to award 9DXZ with the beautiful traffic trophy. 9DXZ won the trophy by handling the most messages in Illinois for three consecutive months. FB, OM. 9AAW is having their DC generator repaired and will soon have it on the air along with the 500 cycle incinerator. 9ACU reports the YL's QRM but still operates on 21 and 38 meters. 9AD reports Prof. Way of the Physics Dept. of Knox college is one of the ops at 9KU. 9AEG using a 210 worked on 6HG. 9AFA is still keeping schedules with WNP with fone on 20 meters. 9AEB is using a new chemical rectifier and sync for plate supply. 9AFF handling mainly army traffic reports everything going honkey dorey. 9AGG was not in operation much this month. 9AHJ with 2 210's worked many foreigners this month. 9AHK, an old timer in the game, is just getting into the traffic end. 9AIJ burned out his old power transformer and is now in the market for a new one. 9ALK reports the YL's keeping him too busy for traffic. 9ALW is attending Armour Institute and will not be in Morrison for some time. 9AMA knocked us all dead with his traffic report this month. FB, OM. 9AMN is using a new third harmonic antenna. 9AMO is keeping many schedules and reports 9DFE is selling out. 9APY hears 9AAW R3. He also reports three hams on in Waukegan. 9AQA forgot to tell us that when he burned his hand on the 1500 volts, he knocked his 250 watt on the floor with dire results. 9ASE has 4 schedules and is working all sorts of DX. 9AWX is keeping several schedules but finds DX bad on 40. 9BHM is laid up in bed with Staphylococcus infection in his back. 9BIZ is putting in his time on Xperimental work. 9BLL is keeping 4 skeds on 84 meters. 9BLS reports the wind blew his Zap antenna down, and he is using an indoor antenna on 20 meters now. 9BMZ thinks QTC the Illinois traffic paper is the berries. 9BNI is keeping two schedules and operates from 6:30 and 7:30 am and pm. 9BRX is attending Armour Institute and finds little time to pound brass. 9BSH reporting for the first time is using a 50 watt and is planning to put in 250

Watts. 9BTX despite the fact that he is taking pipe organ lessons pounds the brass as well as the ivories. 9BVH is operating on 38 and 78 meters. 9BXB has his new 852 working now and is getting some real DX. 9CCZ is changing his xmitter to operate on 40 meters. 9CIA made 30 points in the international contest only operating one evening. 9CKM can't find much traffic bound for Oregon, Ill. 9CNB is re-built and is operating regularly now on 39 meters. 9CNP reports for the first time and is using a remote control and breakin. 9CNY using fone on 150 meters handled a few msgs. 9CUH has increased power to 15 watts and still is keeping schedules with 4VZ. 9CUO sure gets a kick out of the ham game and reports the QRM on 80 is bad. 9CZL is having terrible interference from three 66,000 volt power lines running through his town. 9CZT was off the air most of the month because he moved to a new location. 9DAF reports 20 meters FB for DX. 9DBI reports a new ham 9EPK starting in at Mt. Carmel. 9DCK is keeping schedules with 9DBI and 4KV. 9DGA is trying to operate a 20 meter fone. 9DKK is using a 204A tube on a Zep antenna. 9DOX on 85 meters is keeping schedules with 9CYQ. 9DSSO being off the air since October is back on again with a 210. 9DXZ keeping five skeds reports traffic not so heavy this month. 9EAI reports QRM from work. 9EAJ has a schedule with POB in Brazil and has also worked FQ, PM, NQ, NT, etc. 9EAU is offering a \$15 reward for the information of the wicked one who broke in and stole his 50 watt and transmitter. 9EGX reports his new 210 went to the happy hunting ground. 9EHK has a new call 9DJ assigned at the hospital at Maywood. 9EJO is the first nu to work Afghanistan. 9ELR will be off the air for some time. 9EPG finished his new xmitter with the copper coil inductances and Zep antennas. 9EPX visited 9AWX and 9AJM in Joliet the other day. 9EREH expects to be on the air with crystal control in a short time. 9EYA another new man in the ham game, reports there is nothing like it. 9CNY started off. Good stuff, OM. 9FO, crystal controlled, is operating on 19.7, 39.4, and 77 meters. 9FZ is modulating his xmitter in the center tap. 9KA's xmitter went on the fritz when his rectifier gave up the ghost. 9KB is on almost daily and keeps schedules with 9BXJ. 9MI-PU is operating on 38.5 meters and reports everything going OK. 9RK got his rectifier going at last and is exciting a Zep antenna. 9RP worked 12 oz and on stations in the Tests. 9ZA is still operating.

Traffic: 9AMA 701, 9BXT 323, 9BJL 232, 9AMO 205, 9BZO 169, 9APY 105, 9DXZ 96, 9BXB 92, 9BMZ 80, 9DKK 70, 9CZL 70, 9EAJ 60, 9ASE 62, 9CKM 57, 9DSU 56, 9CNY 45, 9BLL 43, 9DCK 42, 9CUO 38, 9AEG 36, 9MI-PU 35, 9AHK 34, 9DGA 33, 9EJO 31, 9BNI 31, 9CNP 30, 9EPX 27, 9CUH 25, 9AFA 23, 9AWX 21, 9DOX 20, 9CIA 19, 9CNB 19, 9AQA 19, 9AAW 17, 9EREH 17, 9EYA 16, 9AFB 16, 9AMN 15, 9RP 13, 9AD 12, 9ACU 12, 9DBI 12, 9CZT 12, 9CNH 11, 9HSH 10, 9ZA 9, 9ALK 10, 9EGX 10, 9AHJ 9, 9IZ 9, 9BHM 9, 9AFF 8, 9EAI 7, 9FO 6, 9HLS 6, 9KB 6, 9RK 4, 9ALJ 4, 9AGG 4, 9BIZ 4, 9EHK 4, 9EPG 3, 9CZK 3, 9DAF 3, 9KA 3, 9DSO 2, 9BVP 2, 9BRX 1, 9CCZ 1, 9AVL 1.

DAKOTA DIVISION

NORTH DAKOTA—SCM, G. R. Moir. 9EFN—9BPR is using a Colpitts circuit in his xmitter now, 9CUT had 2 fingers badly burned with 1500 volts. Tough, OM. 9BRR is also using a Colpitts xmitter now and says it sure is FB for steady note. 9DYA was off for a week getting his storage battery charged, but is going good now. 9BJV has been QRW to do much traffic work. 9BVF put up a Zep and it seems to work OK. 9DM is using a Zep and getting FB results with a 7½ watt on 40. Traffic: 9BPR 72, 9CUT 2, 9BRR 71, 9DYA 7, 9BVF 79, 9DM 52.

SOUTH DAKOTA—SCM, F. J. Beck. 9DB—The traffic is picking up again with most of the stations active and many keeping schedules. 9DWN leads again working schedules on 80. 9BCJ ran up a bunch of points during the tests but had a fire the last day. 9DQR has an 852 going FB on traffic. 9ADQ and 9EUH have good sigs on 40 and are starting skeds. 9DNS, 9AJP, 9DES are all on 40 with lots of punch. 9BOW, and 9HRI ran up a few points in test and keep a couple of skeds. 9NM had the misfortune to burn out his dynamotor half way through the tests. 9DLY shielded his xmitter and worked oz first try. FB, OM. 9CJS reports new station in Bryant, 9FAZ. 9DB works DX when power leak goes off air. 9BOT is going to farm regularly. 9DIY is QRW with new 222 R.F. amp.

QST FOR APRIL, 1928

9AGL has outfit going FB on 80. 9TI is building a new station and working on 222 amp. 9EIJ is getting out FB on low power. Practically all the stations in the state have enrolled in the S.Dak. A-A secondary net, 9DES and 9EUH handled 40 msgs. for the power company to 9CAJ at Pipestone, Minn., during a sleet storm which took down all wires, antennas, etc. 9DWN assisted in relaying messages.

Traffic: 9DWN 180, 9BCJ 98, 9DGR 43, 9ADQ 36, 9EUH 33, 9DNS 27, 9DES 40, 9AJP 32, 9BOW 22, 9NM 20, 9DLY 15, 9CJS 14, 9DB 11, 9BOT 9, 9BRI 4, 9DIY 2, 9AGL 1.

NORTHERN MINNESOTA—SCM, C. L. Barker. 9EGU—The contest being put on by the SCM in this Section is creating no small amount of interest and some lucky boy will be the proud possessor of one of the new shielded grid tubes for handling the largest number of bona-fide msgs. between Feb. 25 and Apr. 26th. Everyone is going after it with the right spirit and the old gang seems to be pepped right up. 9BIW, a new ORS, burned out his B battery charging generator so has been off the air. 9AOK takes full lead in traffic this month. 9EGU has tried TP-TG with 208A and 852. 9ABV replaced his 210 with a new 50 watt and is surely after the prize tube. 9CWN still uses the 210 with a new chemical rectifier. 9EGF and 3 other "range" hams paid a three day visit to the Duluth gang and report a fine time. 9KV is another QTZ convert on 39.97 meters. 9CF was one of the hosts of the "range" gang. 9CKI is on with a MO-PA set, but can't get rid of his key thumps, such as he tries. 9DPB, another new ORS, has been working with 20 meter phone with wonderful success. 9CJY is installing a new TP-TG transmitter. 9EHO is working on a MO-PA system. 9CTW has his new mercury arc installed with fine results, and changed to TP-TG circuit. 9AKM was very busy but is working to get operating on 20, 40 and 80 meter bands. 9ADS installed a new transmitter. 9RMX got his old set going again on 20.5 meters. 9BMR is getting ready to move his set to another part of the house, when he builds onto the house soon. 9EGN operates only once in a while, as he says its too far from U. of M. to his home to drive home to operate often. 9CWA tried TP-TG but paralyzed his 75 watt. 9BAY almost forgot to report this time. Careful, OM.

Traffic: 9AOK 107, 9ABV 64, 9CWN 53, 9EGF 42, 9KV 38, 9CF 30, 9DPP 24, 9CJY 19, 9EHO 14, 9EGU 12, 9CWA 35, 9BAY 17, 9CTW 12, 9BMT 8, 9AKM 4, 9ADS 4, 9BXM 3, 9BMR 2, 9EGN 1.

SOUTHERN MINNESOTA—SCM, D. F. Cottam. 9BYA-9EFK Acting—9COS keeps six schedules and is on both 20 and 40. He has been appointed RM. 9COS is strictly a traffic station operating in very limited time. 9EFK is now on 20 and 40 and hopes to be able to QSY 30 also. 9DGE reports a nice bunch of traffic and is on with 3 ops, and says schedules will be welcome. 9BTW has been QSO 8 countries in two nights with one CX-310. 9EFO has been assigned an additional call 9EZM. 9DOP is on 20, 40 and 80 and says he can stand some skeds. 9DBW has had time to try the UX222 and says its fine stuff on DX volume and signal to static ratio. He also reports 9EOH and 9EPE at Dundas, Minn., going strong. 9BHZ has been heard with a pretty note as usual. 9DHP still works 1AWE regularly on 20 meters and has been QSO nr and na. 9ELA has everything for a 50 watt xmitter at Marshall High School. 9CLK a non-ORS is on 20 with a 310 and has been QSO sb. 9CIX prefers a 50 to his former 250. 9AIR is dusting off the old portable for this summers local DX. Hi. 9DMA has been QSO fo. oa, oz, sv, sb, etc. 9XI would be on the air but the generator is blown, receiver sold, chief on very QRW, etc. 9DBC is going to A.T. & T. school at Waukegan, Ill. for a couple of months. fo-A3M was heard working 9BKX giving him a good report. 9DEQ is inactive. 9RB-ex-9DUL will be active in Marion, So. Dak., soon. 9EAH has a new 210 now and is on 20 meters.

Traffic: 9COS 166, 9EFK 76, 9DGE 74, 9BTW 52, 9EFO 38, 9DOP 22, 9DBW 17, 9BHZ 17, 9ELA 16, 9DHP 12, 9CLK 10, 9CIX 8, 9GH 7, 9AIR 4, 9DMA 2.

DELTA DIVISION

ARKANSAS—SCM, W. L. Clippard, Jr. 5AIP—Prospects look much better for the Arkansas gang this month. 5ABI came across with the largest single total for some time. 5AQX is the new fellow in Hot Springs. 5JK and 5SS each had a stick blown down. Tough luck, OMs. but 5ABI's 50 watt also blew after working an ep. Hi. 5AIP is on daily but not much traffic. 5AVA rebuilt.

Traffic: 5ABI 56, 5CK 19, 5JK 11, 5AIP 9, 5AVA 5, 5SS 2, 5AQX 2.

LOUISIANA—SCM, C. A. Freitag, 5UK—5AOZ put up a new 30 foot mast especially for the International Tests but got no results. 5PM says, "Not much excitement this month. Messages can be delivered anywhere now. Weather conditions not very good." 5IE is rebuilding his transmitter into a TP-7G self-rectified circuit using two UX-210 tubes. 5RD is keeping two schedules which are going fine, altho he is QRW school. There is only one of the gang here who is interested in 5 meter work (5NE) and his transmitter is not yet completed.

Traffic: 5QJ 18, 5AOZ 1, 5PM 25, 5IE 7, 5RD 7, 5UK 9.

MISSISSIPPI—SCM, J. W. Gullett, 5AKP—The amateur outlook in this state is very bright as several new stations are being heard on the air now. 5YD is on 20 meters now and says they will have a good message total for the month of March. 5LY is now on 43 meters and wants all the gang to listen for his signals. 5AYB is now transmitting on 40.2 meters and is doing good work. 5ANP is transmitting on 40 meters. 5AJJ who has a boat equipped with radio has put up for the winter. 5AGS is heard on the 40 meter band now and we are glad to hear his familiar call again. 5FQ has a UV-240 on 40 meters and reports working oh-6AVL. 5AKP has a 50 watt Signal Corps tube on 20 meters and is working real DX.

Traffic: 5AKP 81, 5AYB 37, 5ANP 14, 5AJJ 12, 5FQ 22.

TENNESSEE—SCM, L. K. Rush, 4KM—Three new ORS are in operation. Let's have those reports. 4SP sends in a good report and reports going to 20 recently. 4LX with a crystal has been QSO with oa oz, oo, WNP, fo, sh, etc. 4TD has had QRM from business. 4ABR finally hooked his brother 6DOK and has a sked with him now. 4ADI says he will be on in full force very shortly. 4ACP has actually handled some traffic. 4ABZ handles lots of traffic and is high man for the month. 4HK is going to install a mercury arc and 852. 4FX comes second in traffic figures. 4KM and 4KX are still here. 4CU and 4ADH is dormant. 4GL handled more traffic than has been put thru in this state for some time but the report didn't get here in time. 4PI showed thru lots of traffic last month. The Knoxville amateurs put on a traffic contest with a 210 as prize. 4ABZ copped the prize with about 140 msgs. He plans to build another set to take to his home out of town. 4ABR and 4ADI are getting along OK. 4ABR turns his first good report in.

Traffic: 4ABZ 89, 4FX 57, 4LX 26, 4HK 22, 4ACP 16, 4ABR 14, 4SP 10, 4TD 2, 4ADI 2.

HUDSON DIVISION

NORTHERN NEW JERSEY—SCM, A. G. Wester, 2WR—2CP, the RM, again makes the BPL. 2WR is on the air and is QSO on all bands. 2BY, 2ANG and 2MD are new ORS. Some ORS still insist on reporting no messages handled and they will be dropped shortly if no traffic is handled. Stations that can handle 4REL broadcasts, please communicate with the SCM. 2AT is back from a trip and on the air again. 2CP handled traffic with all nine districts on 80 meters and notifies all stations that the primary object of 2CP is a traffic station only. 2DX lives up to his call and works DX. 2EY still has trouble with the RI re license renewal. 2JC steps all over the globe and handles traffic, too. 2FC is having a hard time finding time to operate. 2KA is desirous of getting some skeds on 80 meters. 2ASZ will be heard now as a new transformer has arrived which kept him off. 2CJD installed his power supply and relays all in metal cabinets with a result of no more QRM to the BCLs. FB. 2AGN is QRW school and also his aerial came down. 2ANG had no luck during tests but had fine QSO's right after. 2CGK has a transmitter working but also cannot find time to operate it. 2MD, our new ORS, had a fine traffic total. 2BIR is in line for a WAC certificate. 2IS expects two good schedules for traffic. 2AVK rebuilt the transmitter and is having fine results. 2ADL is going South on another trip shortly and will be off the air for a brief period. 2BAL is very QRW due to arrival of a new operator. 2JX works all Europe with an indoor aerial and counterpoise. 2AOP has a phone on 180 and is organizing a 180 meter club which already has five members all active on that wave. 2GX had fine results working Africans and Zedders in the tests on 20 meters. 2BY has had several 2nd and 3rd district hams call at her station to inspect the works. 2JG has applied for an ORS and handed in a fine traffic report. 2ABE still has trouble with

antennas coming down. 2BDF, another applicant for ORS, is keeping a schedule with 8TH and handles plenty of Boy Scout traffic.

Traffic: 2WR 1, 2AT 12, 2CP 263, 2DX 18, 2JC 52, 2FC 2, 2KA 6, 2ASZ 9, 2CJD 7, 2AGN 10, 2ANG 15, 2MD 71, 2CTQ 11, 2CJX 58, 2BIR 46, 2AVK 3, 2ADL 40, 2BAL 2, 2JX 37, 2AOP 21, 2BY 61, 2JG 32, 2ABE 1, 2BDF 31.

NEW YORK CITY & LONG ISLAND—Asst. SCM, J. B. Kilpatrick, 2EV—Manhattan: 2BCB won Aero transmitter coils in Army-Amateur contest. 2BGO has a new QRW now. 2BNL now using RAC in place of B batts. 2BOX put up new Hertz antenna and it's working PB. 2KR is using a 204A now and working real DX. 2OV is taking a portable to Calif. this summer. Brooklyn: 2ADZ is waiting for the lighting company to change his DC to AC. 2BAZ burned out his transformer and has been rebuilding. 2BDM is still looking for good skeds. 2BO seems to be getting out FB now. 2CRB hopes to win a couple of good binding posts in the international tests. 2PF says he reduced BCL QRM to minimum by putting RF chokes in house line.

Long Island: 2ATZ was heard in Europe on 80 meters. 2AJE is away attending Rensselaer Poly. Institute. 2AYB has been stepping out in great style. 2AWQ has had a bad power leak. 2AYS worked two EG's with indoor antenna. 2BSL is rebuilding his portable. 2CTP is working Europe with a UV202.

Bronx: 2ALP has been sick but is OK now and going strong.

Staten Island: 2AFV handled the most traffic this month and is working WNP on 20 meters at times.

Traffic: Manhattan: 2ANX 18, 2BBX 10, 2BCB 36, 2BGO 31, 2BNL 10, 2BOX 24, 2CZR 42, 2EV 11, 2EE 39, 2OV 10, Brooklyn: 2ABP 21, 2ADZ 25, 2AND 50, 2APB 31, 2BAZ 7, 2BDM 54, 2BO 31, 2CRB 24, 2PF 18, Long Island: 2ALZ 66, 2AJE 1, 2ALS 15, 2AVB 37, 2AWQ 7, 2AYS 7, 2BSL 3, 2CTP 20, 2TY 5, Bronx: 2AET 7, 2AHC 39, 2ALP 25, 2BAD 23, Staten Island: 2ABO 24, 2AFV 109.

EASTERN NEW YORK—2ABY reports a new ham in the person of 2BLI. 2CNS is now at his new QRA, 2 Livingston Ave., White Plains, N. Y., and is using an indoor antenna and counterpoise. 2BOW cannot seem to raise any foreigners.

Traffic: 2ABY 99, 2CNS 10, 2BOW 99.

MIDWEST DIVISION

IOWA—SCM, A. W. Kruse, 9BKV—The RM reports everything perking fine and a nice list of schedules throughout the state. FB. 9DRA is the star traffic man this month, with 9EJQ right behind him. 9DZW turned in his usual fine report and handled some WNP traffic. 9BKV is using ICW with good results. 9CZC says traffic seems to be as plentiful as ever. 9CUX is a new ORS and finds lots of traffic on 80. 9PB reports everything perking FB on 40 and 80. 9DEA made the BPL and no schedules! 9DGW blew his 50A and rigged up a couple of 201-As and a 250 volt MG but results were punk. 9BCA and 9EXX handled lots of traffic at the Fort Madison Radio Show. 9BTX, 9FB, 9EJ, 9CUX, 9DLJ, 9RIP and 9AAW also handled great batches of messages for the Show. 9EHN has a new Zepp antenna and reports fine results on 40 and 80. 9CS did fine work on 40 by keeping several skeds. 9CGY works a lot of sixes. 9EIV turned in a good report for a starter. 9EHR is putting in a spark coil CW for emergency work. FB. 9AMG is leaving for college but expects to be on this summer. 9BWN reported by radio and says he is too busy to handle much traffic. 9EIV gets A. C. and RAC reports from her DC power. Hi. 9CJL says he's got spring fever. 9ECO is using a current feed Hertz with good results. 9AYH and 9DPL pound away when they have time. Don't forget the Midwest Convention at Ames, April 18th and 14th. Let's all go.

Traffic: 9DRA 504, 9EJQ 344, 9DZW 298, 9BKV 299, 9CZC 285, 9CUX 259, 9DEA 228, 9PB 216, 9DGW 214, 9DGW 82, 9BAC 200, 9EHN 152, 9CS 78, 9CGY 62, 9EIV 52, 9EHR 48, 9AMG 46, 9BWN 46, 9EIV 45, 9CJL 42, 9ECO 17, 9AYH 6, 9DPL 1, 9EXX 58.

KANSAS—SCM F. S. McKeever, 9DNG—The International Tests seem to have been the main interests in Kansas this month. 9DRD, 9DIH, 9CV and 9DNG-9AEK were among stations entered. 9DRD worked Africa in tests so a WAC certificate will be his soon. 9DNG-9AEK worked all the continents. 9CFN has several fine skeds in all directions. 9HL, and 9CKV are two of the most consistent traffic men now. 9BII reports a new 852 as do 9CLR, 9BUY, 9BPL and 9CPY. 9CFW, 9CNT and 9COR are on the air but not very active. 9LN was complaining be-

cause he could not get out and then pulled an RS from SA1 9EBM which is steadily coming to the front. 9BET is QRW washing machine business.

Traffic: 9DNG 175, 9BUY 5, 9BPL 3, 9BHR 46, 9CPY 5, 9BII 12, 9HL 81, 9COR 11, 9CFN 47, 9CNT 19, 9BGX 5, 9CFW 12, 9CKV 52, 9EBM 12, 9LN 17, 9JU 17, 9CLR 8, 9BET 1.

NEBRASKA—SCM, C. B. Diehl, 9BYG—Our observer says he'll resign if there isn't more business in his line soon. 9CJT, 9AWS and 9CGQ fell flat again this time. 9ANZ hit good in the international test with a score of 9. 9QY working with 20 meter phone says FB. 9EEW is still repairing BCLs. 9DI is very busy with his school work. 9BOQ had a long siege of illness and a death in the family. Sorry, OM. 9CHB says that if any one gets half as much kick out of an ORS as he does, all the radio in the world would be ham radio. 9BBS is working to perfect his filter between licks on the railroad. 9CDB is rebuilding his entire station. 9BQR has a terrible time with QSS caused from power line and QRM from power leaks, etc. 9EBL blew his plate transformer. 9EGJ turns in first report which is a dinger. 9AGD comes up for air and spouts 40 for a change. 9DVR after testing with the BCLs finds that his set does not touch any of them except a few single circuits.

Traffic: 9ANZ 15, 9QY 10, 9EEW 5, 9DFR 7, 9BYG 2, 9CHB 11, 9BBS 31, 9EGJ 46, 9AGD 40, 9DVR 25.

MISSOURI—SCM, L. B. Laizure, 9RR—9DOE and 9BHQ led in traffic in St. Louis this month. 9BEQ tried the tests but had too much power leak QRM to do much. 9BEU combined DX and traffic work. 9BHI was on 20 mostly and traffic suffered. 9DLB worked the 80 band and handled a good total. 9BMU increased his total over January. 9DZN had no traffic due to school and X section QRM. 9ZK kept a 50 on 81 meters and another 50 on 21.4 meters but the 250 on 41.6 was QRT due to blown tube. 9DUD is now an OBS. 9DKG hit the BPL for deliveries. Schedules helped raise his total. 9BOE was lost this month. 9ARA handled a lot of test messages but reception was hindered by power leaks. 9CRM had an excellent traffic report and got R6 report from London on 80 meters. 9CCQ reports several new hams and a good traffic total. 9DAE hit the BPL with 5 skeds in effect. 9BUE is recovering from a siege of illness. 9BQS has been tied up by job QRM and also was off while building Haynes type chem. rectifier. 9LI had a good month but QRM from school. 9LU kept skeds with 9ENU for basket ball game scores and had some good DX. 9ASV received his ORS and put in a sked with 5AXX. 9EUB is a new traffic station in Joplin. 9ERR is a new station in Stockton, operated by the father of 9CDF. 9CDF is temporarily absent working W.U. job in Kansas and carrying portable transmitter. 9ERR and 9BUE are on 150 meter band. 9BVC, the new 60, turned in a good off-wave operation report. 9AJW and 9ERM have a station going in Fulton handling traffic. 9AVS and 9DZP continue active but reports are nil. 9ENU hit the BPL this month for good deliveries. 9RR also had a good month but was unable to operate enough to be a BPL member. 9LD and 9ENU secured 9FAU as the call for their new station at Overland Park, Kans. 9ADR is QRT going to school and operating 9FKU. 9EMH clicked with Asia this month. 9ACA is still QRT after moving. 9DQN doubled his traffic this month. 9DOJ appears on the traffic sheet after an extended absence. 9AYL and 9AHZ were QRW with tests. 9DLL moved and blew two 210s and 20 mikes of condenser. 9D put in most of his time with X work. 9WV and 9BSB were on considerably but traffic did not materialize. 9RR made two skeds and kept them for two weeks then job QRM obliged QSK. 9ABO is the call assigned to the N.R.F. 100 watt station. 9DQN was appointed A-A station. 9DRY is on frequently. 9EUR of Denver visited the hams in K.C. during the last week of February. The new ham column was dropped from the K.C. Post and QSY'd to the K.C. Sunday Star, thanks to 9EMH.

Traffic: 9DOE 140, 9BEQ 80, 9BEU 19, 9BHI 15, 9DLB 39, 9RMU 12, 9ZK 26, 9DKG 120, 9BUE 10, 9ASV 10, 9EUB 4, 9LJ 25, 9LI 16, 9BQS 1, 9DAE 330, 9CCQ 33, 9CRM 154, 9ARA 94, 9DQN 21, 9ENU 101, 9EMH 2, 9DOJ 46, 9RR 208, 9AJW-ERM 14.

NEW ENGLAND DIVISION

CONNECTICUT—SCM, H. E. Nichols, 1BM—1VB, 1CTI. 1ASD have made the grade for BPL this month and deserve most honorable mention for their efforts in keeping traffic on the jump. 1VE and 1IM report traffic coming through very nicely on

schedule operation. 1VE is displaying a new AA appointment. 1BWM and 1CTI have recently completed a map of active ORS in Conn. which is FB. 1BHM and 1BJK report things moving very nicely in New Haven and with the AA work, 1BJK sure is helping the Electric Co. out. 1MK has finally got into operation again and from the sound of that powerful signal can understand why they went up on the 80 band. RP who hails from the West and used to be old 9WR is the new op. We sure welcome you, OM. 1MY has finally decided the eighty meter band is pretty fair for local DX and has started some schedules. 1ATG has recently come up to the best traffic band and is handling a goodly bit of traffic and we are pleased with his results. 1ADW and 1OS have been keeping the Danbury section of our state in fairly active condition.

Traffic: 1BQH 2, 1BGC 7, 1OS 13, 1AMC 14, 1BLE 14, 1NE 18, 1TD 24, 1MK 26, 1MY 23, 1BHM 33, 1ADW 48, 1BWM 52, 1AEF 54, 1BJK 72, 1ATG 80, 1IM 81, 1AOT 82, 1ASD 85, 1VE 112, 1CTI 204, 1VB 265, 1AMC 13, 1BNS 148.

MAINE—SCM, Fred Best, 1BIG—1CDX sent in a good total which shows what a real schedule will do for a ham. 1BUB is working both the 40 and 30 bands with good results. 1AIT is back on 81.5 with a fine note and a wicked punch. 1BAY, a new ham, turned in a mighty fine total this time. 1AJC turned in a fine report, showing that Portland is at last on the map when it comes to traffic. 1BFZ says he has been kind of neglecting the 80 meter band. 1AQL is on from 6.30 p. m. to 7.00 daily. He reports the new call letters of the Queen City Radio Club as being 1AKR and says that new members are coming in all the time. 1AUR says that there is all sorts of activity in Livermore Falls, with 1AQD, 1AHY, 1AXP and 1IP on the air. 1ASJ found that he could work Europe with lowpowered set, so he has temporarily laid off the traffic game. 1FP reports that due to his new job he will not be able to be on so much now. 1ATV reported by radio that his transformer has been burned out the early part of the month. 1BIG is hard at work getting an USNR organization under way and desires to hear from Bangor and Portland hams who are interested in putting their respective cities on the map with a real honest-to-goodness USNR unit.

Traffic: 1BIG 203, 1CDX 64, 1BUB 54, 1AIT 50, 1BAY 45, 1AJC 31, 1BFZ 18, 1AQL 10, 1AUR 2, 1ASJ 2.

NEW HAMPSHIRE—SCM, V. W. Hodge, 1ATJ—Traffic this month was scarce due to the many stations taking part in the Tests. 1IP pumped out a bunch with his 201A, and worked Kansas City with an input of 2.3 watts. 1AEF, in spite of a blown tube, worked good DX and handled his share of traffic. 1ANK is a new station reported by him. 1BFT reports a bunch of stations and ops at NHU. One of them, 1IH made 66 points in the Tests. 1ANS says he didn't report last month as his OW cleaned out his shack and he couldn't find anything left to report. H. LAOQ is working a few on 20 and 40. 1ASR has been authorized by the Fed. Radio Comm. to work in the new 10 meter band. 1BFT, 1IP, 1ALY and 1AEF are enlisting in the Naval Reserve. 1JN reported direct to HQ this month. The SCM hopes to meet the NH gang at the Convention. See you there, OM.

Traffic: 1IP 168, 1AEF 120, 1ATJ 80, 1AOQ 51, 1ASR 33, 1ANS 24, 1BFT 23, 1JN 28.

EASTERN MASSACHUSETTS—SCM, E. L. Battery, 1UE—Eight stations make the BPL with 1FL as the star traffic pusher. 1AKS, 1CRA, 1LM and 1WV all turned in enviable reports. 1SL has been appointed as Official Observer. 1BVL, 1AXA, 1ADM, 1ABA, 1ACH, 1BW, 1RY, 1KH, 1WV and 1ON all took part in the International Tests and nearly all had good luck. 1AKS is operating at WIM. Schedules are still desired by 1YC. 1BVL worked fo-A7U and fo-A4E. 1ABA got R8 from New Zealand FB. 1ADM had his 60 foot mast up again but it had another downfall. He will be back on 30 soon now that the tests are over. 1KH and 1WV, the rivals, worked too much DX to list. DX reported good by 1BKV. 1NK says he will be on more regularly now so you traffic men should watch for him. 1ACA says 80 is getting as bad as 40 as far as QRM goes. 1BDV finally got Zep feed working, but school QRM keeps him off the air quite a bit. Two new hams are being tutored by 1AHV. 1NV still finds time to pound now and then. 1APK has been appointed Monitor Station in A-A Radio System. YLs take some of his time, says 1IN. The BCLs have 1AVY on the jump, fixing their receivers. 1ASI has rebuilt and is keeping some skeds. The

fact that he was QRW accounts for small totals says ICRA—look at his total, gang. Naval Reserve drills are going pretty smoothly now with 1VR, 1MR, 1RL, 1AQE, 1LM and 1UE taking part. 1KY, the RM, wants to know what is wrong with the ORS. 1FL has lots of schedules. Plans are being made at E.M.A.R.A. for the New England Convention to be held in Boston at the Elks Hotel Apr 20 and 21st. It should go over big and will surely go over with the cooperation of the gang. Let's all plan to attend and meet one another.

Traffic: 1FL 501, 1CRA 335, 1LM 198, 1WV 196, 1KY 135, 1KH 61, 1ACH 36, 1UE 65, 1ABA 141, 1YC 47, 1SL 27, 1AGS 24, 1ASI 23, 1AHV 25, 1ON 7, 1AXA 114, 1AKS 361, 1NK 8, 1RY 9, 1BKV 11, 1BVL 8, 1APK 16, 1ACA 48, 1NV 12, 1ADM 2.

WESTERN MASSACHUSETTS — SCM, A. H. Carr. 1DB—1AJM is quitting the ham game. Sorry to hear it. OM. "Kit" Duval is operating the station at the YMCA under his own call 1AMW. 1AKZ says he would like to know what part of the 20 band some 9's hear Aussies at 8 am. 1AMZ has been on the air regularly in his vacation periods. 1ANI has joined the Naval Reserve net. 1APL kept a bunch of skeds as per usual and had a fine traffic total. 1AZD says he is just catching up on lost sleep after the contest. 1BIV has at last got back on the air again and says he hopes to be on regularly. 1BKQ is now the call of the radio club here and they have several ops. 1ANI says anybody desiring skeds, write to him. The Springfield Radio Assn. have their new station nearly ready. 1PY has moved but says he will be on the air again soon. 1IL of Springfield, Mass., is a new ORS. We all wish him the best of luck.

Traffic: 1AJK 3, 1AJM 38, 1AKZ 30, 1ADO 15, 1AMZ 13, 1ANI 93, 1APL 151, 1ASU 2, 1AZD 266, 1AMW 6, 1BIV 7, 1BKQ 7.

RHODE ISLAND—SCM, D. B. Fancher. 1DB—Sickness in the family has kept 1AMU off the air this month. 1MO says that the tests put a crimp in his traffic this month. 1AWE's DX reads like a geography, and his traffic total isn't so bad either. 1BQD scored 27 points in the Contest and his traffic suffered. 1EL sends his traffic report but no news so don't know what he is doing. 1BAT hooked WNP this month and got the bulk of his traffic on 40. 1AQP handled some foreign traffic. 1BVR has gone back to the Hartley circuit as the other couldn't be made to work satisfactory. 1BIL handled some emergency traffic during the big Fall River fire. F. B., OM. Our star station this month is 1BLS, the new station at Newport. 1AAL had to build a new rectifier as it broke down the first of the month.

Traffic: 1BLS 71, 1BIL 33, 1BVB 31, 1AQP 27, 1BAT 24, 1EL 17, 1BQD 14, 1AWE 13, 1MO 8, 1AMU 4, 1AAL 10.

VERMONT—SCM, C. T. Kerr. 1AJG—Will the stations that were entered in the last tests notify 1AJG how many points they had as there are some prizes here that were donated and will be awarded by the SCM when your report is confirmed. 1IT has been appointed Asst. SCM. 1AJG is now on 80 meters. 1BBJ is in NYC now but will go west for another month and we sure will miss George's DC note perking through on AA stuff. 1BD has the only crystal xmitter in the State and using an in-door antenna. 1ATU was QSO on 20 meters. FB. 1AD is now on the 80 meter band and has skeds with 1AJG. 1A00, a new ham in Richford, perks out FB and is applying for an ORS. 1FN scored 3 points in the recent tests using a Zep antenna. 1BJP maintains good contacts on 83 meters. 1EZ is our 20 meter experimenter and does good work on fone. 1BEB is doing 1BBJ's job in his absence. 1BCK is an AA station with lots of traffic coming through from him. 1NH perks out fine on low power and more power to him.

Traffic: 1NH 31, 1BEB 21, 1EZ 9, 1BPJ 37, 1FN 9, 1IT 120, 1ATU 3, 1BBJ 29, 1AJG 51.

NORTHWESTERN DIVISION

MONTANA—SCM, O. W. Viers. 7AAT-QT—7AJU leads this section again this month and reports that he will soon return to the west coast to pound brass on the sea again. We'll miss you, OM. 7EL has trouble going east and would like a schedule with some of the eastern gang. 7DD says his crystal set works nicely on 84.8 meters. 7FL handled a few but is cramped for time. 7ZU is on 84.5 meters when he isn't too busy. 7AFM couldn't find a reporting card in time so jotted the report on a "gram" blank and sent it in anyway. 7AFW has been on the sick list but is doing a little

work now. 7AFP from Red Lodge got his 210 on and worked a few. 7AHG has built a new TP-TG transmitter, but she still refuses to talk. 7OW is still getting on the receiving end of the programs from eg-5SW on 20 meters. 7AAT-QT now has a 900 cycle supply for the 352 and will soon be on with a 210 and a 500 volt MG. Those, in this part of the country, interested in copying the official broadcasts from this section may find the following a help. 7AAT on 38.2 meters at 5 pm MST every day except Sundays. 7AFM on 40 meters 9 to 11 pm daily ex. Sat. 7EL, 41.6 m. Mons. at 9 pm MST and Thurs. at 7 pm. 7DD, 1 pm 21 meters, 5 pm, 42 meters, 11 pm 83 meters, 7AAW. Mon. Thurs. Sat. and Sun. 2:30 pm 41.75 meters. 7FL Mon, 40 meters 7:30 pm. Fridays, 40 meters 7:30 pm, Sats. 21 meters, 2:30 pm.

Traffic: 7AJU 39, 7EL 21, 7DD 20, 7AAT 14, 7AFM 11, 7FL 6.

OREGON—SCM, R. H. Wright. 7PP—7AEC takes all the honors this month. 7AEX is using TG-TP circuit. 7UN is using 20 meters entirely, says that he can't work anything on 40. 7PL, a new ORS, is a promising traffic station. 7OQ held four days of regular contact with SS Guide enroute to Hawaii. 7HV a new amateur at Toledo, is using a UX210 supplied with B batts. 7FU has installed ICW to relieve the BCLs of key clicks. 7ABH says he worked three Africans in two days the long way round. 7MH is QRW with school at present but will be on regularly this spring.

Traffic: 7AEC 364, 7MH 46, 7OQ 27, 7ABH 21, 7FU 20, 7PL 13, 7UN 13, 7AEX 7, 7AKK 5, 7HV 4.

WASHINGTON—SCM, Otto Johnson. 7FD—New ORS are 7BM, 7BB, 7ACA, 7QG, 7BR, 7MP, 7DF, 7EK, 7VK and 7AG. Tommy Baird, 7VL, of Spokane, has been appointed RM for Eastern Washington and it is expected that traffic totals will begin to show a healthy increase. The small totals this month are due largely to the Tests but next month will be another story. The new ORS are all live wires and it is hoped that the nice certificate will inspire them to make the BPL the first month. Old ORS who were not reappointed but who believe they are entitled to a ticket are requested to write the SCM. Better cooperation will mean more and better ORS.

Traffic: 7QG 32, 7KO 31, 7VL 14, 7TX 12, 7AFP 9, 7MP 8, 7TZ 7, 7IV 7.

PACIFIC DIVISION

LOS ANGELES—SCM, D. C. Wallace. 6AM—6AM and 6BSN make the BPL this month. 6BSN is keeping some good schedules and one message handled from Phoenix covered 16,000 miles before it reached Fresno. 6ZBJ is keeping some good schedules. 6BZR is still rebuilding and is putting up a Hertz sun. 6QL had a chat with OM Russell of am-3AB. 6RFP handled several messages from China. 6AWQ extends a general invitation to the gang to come to Lake Arrowhead and pound brass to their heart's content, day or night. 6DKX located a private C. F. Moore at Manila, P. I. within ten days, after mails and cables had failed during period since Sept. 20, 1927. The U. S. Army Recruiting Officer in Los Angeles referred the boy's parents to 6DKX. 6BZC put in more power there but has been off the air most of the month. 6BJX says QRM from other work leaves little time for radio and that 6DDX (ex-on-5AP) was a big success in a play. 6BJX has had a visit from 6DDX's YL. 6DOW is a new contributor with his first report but is going to report every month from now on. 6COT has a sister attending Redlands University, and gets the news to her in ten minutes through 6BFP. 6ANN, after trying all kinds of antennae, is at last sold on the Zep. 6DPK is off the air temporarily because of change of QRA. 6BXD missed reporting because he got married. 6DGT got a new 50 watt set going and hopes to get in more traffic and DX. 6CUH handled a message for a business man in OH who wanted his wife in LA to meet him in SF on a certain date. 6HDKI told him that the man was very tickled with the PB service. 6ABK got 18 points in the contest and thinks the contest was sure FB. 6BTS had transmitter trouble but will be going full force again this month. 6ALZ says XKV5 is a lumber scow off the coast of Nicaragua, and wants to work the gang. 6AIR's tube went west and he is rebuilding. 6DEG is working on a short wave super-het. 6DPY says a radio club is being started in Bakersfield by him and 6WZ. 6BVT is trying to get a sked with Hawaii. 6CLK, 6BHR, 6AIO, 6PY, 6BRO, 6OF report as usual. 6AM finds the screen grid

receiver is great. His 6 phase transmitter was described in February QST. He has also been acting as chairman inductive interference committee for the Radio Trades Assn. of Southern Calif.

Traffic: 6AM 128, 6BSN 115, 6ZBJ 68, 6BZR 68, 6QL 57, 6BFP 48, 6AWQ 45, 6DKX 44, 6BZC 43, 6BJX 41, 6BGC 25, 6DCH 22, 6CHT 20, 6AGR 19, 6DOW 16, 6COT 16, 6ANN 16, 6DPK 16, 6BXD 15, 6DGT 12, 6CUH 11, 6CAG 11, 6AKW 11, 6CQM 10, 6ID 10, 6CZT 10, 6BVT 9, 6CMQ 9, 6SJJ 8, 6ABK 8, 6BTS 7, 6ALZ 7, 6ALR 6, 6DEG 6, 6DPY 3.

SANTA CLARA VALLEY—SCM, F. J. Quemont, 6NX—Nearly all the stations entered the tests this month but notwithstanding the traffic seemed to move the same as other months. 6AMM was badly handicapped by power leaks, but the PI sked still held up. 6BCH was second in traffic this month and is showing a gain each month. 6BMW got his crystal going on 20.8 and reports everything FB. 6BMW is the RM. Write him for skeds, and he will also check your QRH. 6BYH reports that between the tests and a QRE, hasn't much time for traffic. Hi. 6BAX was QSO plenty of DX this month. 6AOD, the new 00, is working the three bands but reports DX ND. 6CJD is still traveling around but hopes to get located soon. 6BNH was QRW this month. 6BVY seems to have retired from the traffic game. Let's hear from you, OM. 6NX was commissioned Ensign in the USNR this month.

Traffic: 6AMM 300, 6BCH 54, 6BMW 30, 6BYH 29, 6BAX 21, 6AOD 7.

EAST BAY—SCM, P. W. Dann, 6ZX—Well gang, by the time this goes to press, you will probably be acquainted with the new SCM, J. Walter Frates, Jr., 368-62nd St., Oakland, Calif. It is earnestly requested by the outgoing SCM that you fellows bury your hammers and get behind Frates 100%. I sincerely hope that you ORS will make a better showing for the month of March than for Feb. You fellows elected Frates to the SCM job so get behind him. With your entire support, he'll make the East Bay Section THE Section but there'll be no room for the laggards. 6ALV is going to Alaska. 6BBJ entered the International Tests and is building 20 meter CW so not much doing. 6RPC also in tests but also has skeds with na-7KN. I want to thank those who assisted me while SCM of the East Bay Section and again request that all get behind the new SCM and assist him in making the East Bay Section the best ever, and help put over the coming A. R. R. L. Convention. 6CGM complains of a bad power leak. 6BUX got the old 50 on for the second week of the Tests but just as he got all set, his power transformer blew. 6AMI sold his MG. He says 80 is better than 40 for night work. 6COL has a 20 meter Zepp that works FB. 6CLZ will be on more regularly in about two weeks but still has had QRM from U. of Calif. when it comes to studies. Hi.

Traffic: 6RPC 24, 6ALV 8, 6CGM 80, 6BUX 40, 6AMI 70, 6COL 8, 6CLZ 1.

ARIZONA—SCM, D. B. Lamb, 6ANO—6BJF reports several new hams in Phoenix. 6CDU reports again after two months missed. 6AZM says local QRM makes it almost impossible to work through. 6BWS says that 6DAU, 9ENM and himself have the best traffic hookup in this part of the country. 6CPX a new ORS although an old timer coming from Calif. attending the U. of A. 6ANO has been working some DX and handling some traffic. 6DWQ is ex-9ADI of Colo. Springs using a 204A in Hartley with recto bulbs. 6DSA is a new station but an old timer back of the key using a small set. 6DIE sports a mercury arc now and is proud of it. 6DRH says its very difficult to QSR Calif. on 80. 6BWS leads the state in messages this month. 6DRH is next.

Traffic: 6BJF 97, 6CPX 34, 6BWS 116, 6CDU 10, 6ANO 56, 6DRH 113.

SACRAMENTO VALLEY—SCM, C. F. Mason, 6CBS—The SCM reports enthusiasm picking up. Three stations reported this month. That is better but there is still room for lots of improvement. The club meetings are getting bigger each time.

Traffic: 6CDK 8, 6DON 15, 6CIS 12.

HAWAII—SCM, F. L. Fullaway, 6HCFQ—The annual winter fade-out effect seems to have cleared up somewhat and as a result, there was more activity among the hams. 6AVL, working on both 20 and 40, has the high traffic score. 6DJU has been experimenting with zepelin antenna and 20 meters with good results. 6BDL got in part of the international tests but had trouble with his generator. 6DPG has built a 201A self-rectified 20 meter transmitter. 6DCU is trying 20 with no luck. His 50 blew so he hit it and made it work. Hi. 6CLJ is on

19 and 38 with 250 watts. 6CFQ is now on 20 with very good results. 6DEY is building a xtal control xmitter with a 500 watt power amplifier. 6DB keeps a regular sked with his relative 6KS in L.A.

Traffic: 6AVL 114, 6BDL 29, 6DB 26, 6CLJ 23, 6DPG 18.

NEVADA—SCM, C. B. Newcombe, 6UO—6LB has his xmitter working on 19.5 meters now and reports good results. 6ABM is not on much lately as he has been too busy.

Traffic: 6ABM 11, 6LB 21, 6CHG 19, 6UO 20.
SAN DIEGO—SCM, G. A. Sears, 6BQ—Now that 6BXI has a WAC he has sold his fifty and uses 15 watts. 6AJM leads the Section in the recent Tests. 6BAM finds lots of traffic on the 30 band. 6EC keeps daily sked with nm-INIC and handles a pile of tfe. 6BQ still finds time to handle some traffic and sticks to ultra-audio xmitter. 6BYZ keeps busy trying to line up more skeds in Orange County. 6EC has been appointed 00. 6BWI is building a new 50 TP-TG. 6CNK keeps two skeds. 6DAU has been sent to sea and resigns as ORS. Sorry to see you go, OM. 6FP has cleared up a pile of trouble for the BCLs and amateurs in San Diego and vicinity. 6OX was heard on the air again recently. 6BAS plans on trying out the 10 meter band. 6BFE is QRW digging ditches. 6BDE has a 3rd district station recently. Supervisor of Radio for the 6th Dist., Mr. Linden, held examinations in the Federal Bldg., San Diego, recently and was greeted by a full house.

Traffic: 6BXI 216, 6AJM 183, 6BAM 158, 6EC 125, 6BQ 98, 6BYZ 48, 6BWI 22, 6CNK 18, 6DAU 14, 6FP 14, 6OX 9, 6BAS 6.

PHILIPPINES—SCM, J. E. Jimenez, 6PIAT—The SCM sends in the Philippine report for the last three months, listing just traffic so it goes as follows:

Traffic: November: 6PIER 593, 6PIDR 362, 6PIDL 136, 6PIAT 27, 6PIZ 10, December: 6PIER 664, 6PIDR 332, 6PIDL 168, 6PIAT 28, 6PIZ 18, January: 6PIER 719, 6PIDR 103, 6PIDL 144, 6PIZ 16, 6PIAT 3.

ROANOKE DIVISION

NORTH CAROLINA—SCM, R. S. Morris, 4JR—4DQ is going up to 80 as too much "pse QSL cul 73" on 40. 4AB seems to be taking all honors for traffic lately. 4VH is trying to catch up with 4AB but missed again. 4ADJ is increasing the capacity of his Edison battery plate supply. 4OC had fine luck in the international tests. 4EC is now located at New Bern and punching the key at 4EA. 4EA is going strong with a 250 watter. 4OH had trouble with his plate transformer during the tests. 4JR has been QRW tests and convention. Traffic: 4AB 116, 4VH 78, 4DB 60, 4EC 19, 4JR 9, 4EA 8, 4DQ 1.

WEST VIRGINIA—SCM, H. S. Hoffman, Jr., 8HD—8VZ did some fine work on schedules using one 852, working 6BN for ten consecutive evenings. 8ACZ is on 175 meters and also on 20. 8AUL took an international test message from ni-GREN. 8CLQ worked fo-A5T during internationals. 8DPO working west coast with new set. 8BJG back for vacation and heard on several times. 8BNZ and 8OK reported rebuilding. 8DEW getting out good. 8HD when not QRW from school work has sked with 4KF. Several of the gang anticipate being at the Charlotte Convention. 9EI visited Huntington and 8ALG visited 8HD.

Traffic: 8VZ 407, 8ACZ 91, 8BPA 18, 8HD 8, 8AUL 5, 8DEW 5, 8CLQ 4, 8BBM 4, 8BJG 3.

VIRGINIA—SCM, J. F. Wohlford, 3CA—3CEL had to close up, blew last fifty watter and can't find any more. 3KU QSKd all skeds for the tests, had rotten QRM from power leaks and made 90 points and 49 foreign QSOs. 3JT blew his UP-1016 and had to close up most of the month. 3WM made 80 points in tests and about 35 foreign QSOs. 3TN also QRX for tests but had no luck. 3AQY and 3ARB are new stations at Ocean View. A new ham will be on at the Naval Operating Base, Hampton Roads, soon. 3EC has been handling some traffic. 3CEL claims no traffic but works around among the hams every night. 3BGS is preparing for the new power set. 3KG is also waiting on the new line for his new transmitter. 3AG continues to reach out after them at spare times. 3NM is QRW exams and had to cancel all skeds. 3PO is a new ham at Charlottesville. 3IE sends in his report through 3NM and handled a few messages. 3CKL has his xtal control set going now on 40 meters. 3CA is working on a new transmitter and will be

back soon. 3BZ attended the board meeting at Hartford and now has the bug again. 3BDZ is still tinkering with his xtal set. He and 3CKL are enroute Charlotte convention.

Traffic: 3KU 180, 3CEB 88, 3JT 25, 3WM 5, 3TN 64, 3EC 25, 3BGS 8, 3AG 10, 3NM 23, 3EI 4, 3CKL 21, 3CA 119.

ROCKY MOUNTAIN DIVISION

COLORADO—SCM, C. R. Stedman, 9CAA—9EAM comes forward again this month with his regular pile of msgs. FB work, OM. 9CAA is still looking for a mercury arc rectifier. 9DQD is on a transcontinental route now and says traffic is generally going ahead. 9ENM is kept busy training BCLs to become hams via the code class. 9DRV is going to try 80 meters—maybe. 9DQV has been experimenting and so was not on much. 9CCM has to cover her set up every time it snows so it won't get all wet. 9CAT put in a motor generator set and hopes to set the world on fire. 9UDE has been too busy with the international tests to do much traffic work. 9CAW finally got his receiver working in first class shape but the wave of the transmitter jumps all the way from WIK to WIR. HI. 9DGI has been on but says no traffic. 9EEA was in Hartford attending the Directors meeting. 9EJW is as active as ever. 9BYC is rebuilding for 40 meters.

Traffic: 9EAM 284, 9CAA 98, 9DQD 67, 9ENM 20, 9DRV 18, 9DQV 7, 9UDE 5, 9CAW 16.

SOUTHEASTERN DIVISION

ALABAMA—SCM, A. D. Trum, 5AJP—5AKK sent in a fine one about Birmingham. 5AX is doing splendid work out at Robert's Flying Field. They have a fifty watt set under the call of 5RR, 5AS, the old Morse op, is xing on 20 with indoor antenna system. 5PD is off the air until his license returns. 5MI is on again with 60 watts. 5SO with the old reliables Bell and Ansley are on now with an 852 with 2000 AC. 5ARG, the ship op, is coming along fine using a Hertz and getting out splendid on a 210. 5AXN has a 200 watt Telefunken going fine and working all countries. 5WQ not only works his radio good but plays a mean moaning sax. 5DT is in love and the fellows call him the "Love Bird". 5AKK just returned from Atlanta and says that the gang there couldn't have treated him more royally. 5AR is going to be inactive for a while longer. 5UY is using a freak transmitter consisting of a 210 built in a cigar box with the usual loading coils on a 140 ft. ant. with 200 volts battery DC on the plate. 5AYL is doing his bit at Huntsville. 5AAD is coming back in fine style. He had the pleasure of a visit from 4HQ of Pensacola on Naval Reserve Duty. Montgomery is going strong. 5ADA has been working in spare time but finds time to work his set. 5ATS just got his new transformer which he ordered after burning out a perfectly good generator and says he is set for a good month. 5ATJ, a new ham, is doing his share of good work. 5JY had the misfortune of having his battery go west on his receiver. 5AJP is in a dormant state.

Traffic: 5AAD 26, 5AX 32, 5AS 16, 5PD 4, 5ARG 12, 5AXN 32, 5WQ 16, 5UV 68, 5AYL 25, 5ADA 21, 5ATS 26, 5ATJ 3, 5JY 35.

FLORIDA—SCM, C. E. Ffoulkes, 4LK—The SCM is very pleased to see the large amount of traffic handled this month. 4ACV and 4PU dropped in to see the SCM this month, also 8BZZ of Zanesville, Ohio, and WSQ and WSP. 4BL leads the gang in traffic this time. Traffic has picked up with 4TK since installing his mercury arc rectifier. RL of 4LK is "In the Navy Now" and hopes to make the Academy. 4OB is the proud owner of a WAC certificate now. 4CK gets R9 reports in Europe. An 852 is stepping out for 4AAO now. 4BN handled traffic for the So. Florida Fair. 4MS made a talk over COA on ham radio. 4RK is leaving for the North very soon. 4ABJ is sitting behind a couple of 301As. Very glad to hear from 4CH who worked en-OGG. 4KC says 80 is the berries. 400 has a murder-cycle now. 4NE is back on the air after a long illness. 4HY says he still has hopes of getting a WAC.

Traffic: 4BL 101, 4TK 70, 4LK 68, 40B 65, 4CK 64, 4AAO 56, 4RN 40, 4MS 30, 4RK 22, 4ABJ 15, 4CH 14, 4KC 10, 400 6, 4NE 4, 4HY 4.

GA.-S.C.-Cuba-Porto Rico-Isle of Pines—SCM, H. L. Reid, 4KU—Georgia: 4RN in bad with power interference and only made 99 points in the international tests and his best DX was oa-6SA. 4KY had a nice report and has five skeds arranged. 4ABS sends us the dope on the Columbus gang. 4NQ received a fine letter of recommendation from the Corps Area Signal Officer about the low wave work he has been doing lately. 4FE lost his plate transformer and is rebuilding pending the arrival of a new one. 4PA is being reported in England with a 201-A with 160 volts on the plate.

Porto Rico: 4KD sends us the dope on the PR gang but claims that they are not coming through as they should. 4AAN handled news of Lindbergh's Caracas to St. Thomas flight to nu-2UO via xnu-KGAA, the Yacht "Aras." 4JE and 4KT have been busy with arrangements for broadcasting Lindbergh welcoming through WKAQ. 4KT ran a Radiola 17 with loud-speaker for the public. 4UR had the misfortune to get a few ribs broken and has been unable to be on. 4KD is still rebuilding and is ready for a two weeks vacation in San Juan. 4AAN is going to put on a 50 watter with MG. 4XH is the experimental station of the Bull Insular steamship company at Loiza, P. R.

South Carolina: 4AAM has taken over his Dad's drugstore and has changed his skeds to midnight. 4EL says traffic is certainly humming his way.

Traffic: 4EI 146, 4AAM 17, 4ABS 34, 4KY 186, 4RN 78.

WEST GULF DIVISION

SOUTHERN TEXAS—SCM, E. A. Sahn, 5YK—One of our new stations is 5RV of San Antonio. We are glad to get your most interesting report, OM. 5SC, the club station is in his back yard. 5ATM of Lufkin, Tex. is another newcomer. He says there are two others, 5AWW and 5AZL in that city. 5ALA reports another ham, 5CO, in Refugio. 5ALA is working with two 210s using 850 on plates. 5EW is working mostly on 20 meters now but says he has little time to operate. 5AMG reports that his tubes went west but that he will have more presently. 5ZU says that he can be on only after 11 pm and has to get up early so he does not have very much time for work. Your SCM is working frantically to go on the air again himself and hopes to be with you soon as 5GW.

Traffic: 5ATM 11, 5ALA 5, 5RV 74.

OKLAHOMA—SCM, K. M. Ehret, 5APG—The First West Gulf Div. Convention held February 10th and 11th proved a great success and indicates a greater development of amateur radio in the Division. 5ANL still keeps skeds. 5AMO is RM, taking the place of 5FJ who has gone to Washington to attend radio school. 5ANT arranged more skeds and hopes to have an 852 doing its stuff soon. 5AIR reports having a great time at the Convention and helped a man find his mother via amateur radio. 5AYO handled considerable traffic and gets a real punch out of his 210. 5VH had flu and his traffic total dropped as a result. 5AZG has moved and had to crate his set temporarily. 5AFX gets out fine now with a pair of 852's. 5AAV built a chemical rectifier after trading his sync and seems to get as good results. 5APG keeps naval reserve skeds. 5SW finally dropped down to 20 meters and reports results FB. 5QL tore down his big set after the Tests and is going to rebuild.

Traffic: 5APG 14, 5AAV 10, 5AFX 15, 5ANL 19, 5AMO 24, 5ANT 60, 5AIR 9, 5VH 12, 5AYO 32, 5SW 14, 5QL 66.

NEW MEXICO—SCM, L. E. Radka, 5TT—Conditions in general seem very poor, altho the msg. total and stations handling traffic are better than previous months. It seems impossible to inject any "pep" into the inactive stations in this Section. Come on, fellows, if you expect this section to stay in existence, do your part and get things started. 5APB reports traffic dropping off. He keeps daily skeds with 5TV but says he is bothered with skips because of the short distance. 5RO is rebuilding the old xmitter. He reports three active stations in Las Vegas at present. FB, OM. 5TV, with his low powered transmitter, is again high man in traffic totals, but complains of no DX. 5BH is keeping skeds with 9CDE and reports traffic very slow.

Traffic: 5TV 26, 5APB 22, 5RO 12, 5BH 16, 5TT-LG 2

CANADA

MARITIME DIVISION

NOVA SCOTIA—SCM, W. C. Borrett, 1DD—This is the first time for three months that the Nova Scotia Section has been included in the Maritime report, due to the fact that only 1AE has taken the trouble to send in his report. The SCM cannot make up reports from his imagination. 1AE has schedules with VCJ, VCB and VBY and has done most of his work on 52.5 meters. 1AR, 1DJ, 1DD, 1AC, 1AW, 1CC, 1DQ are all located in Halifax at present but activity is rather small. Perhaps the time is ripe for a young convention. The SCM would welcome suggestions from Nova Scotian members of the ARRL as to how to revive interest.

Traffic: 1AE 42.

ONTARIO DIVISION

ONTARIO—SCM, W. V. Sloan, 9BJ—9BZ GOES OVER THE TOP DURING INTERNATIONAL TESTS AND LEADS DIVISION BY SCORING OVER 90 POINTS. VCB AND VBY, FAR NORTH CANADIAN STATIONS MAKING REGULAR USE OF 52.5 METERS. Southern Dist: 8IA turns in a rather brief report this month as the fellows are all too busy collecting points in the International Contest. 3RG reports a new man active in Leamington, with a xtal controlled set, 3UD has been settled again now for a few weeks. 3IA joins the ranks of ROTAB's by hooking with eb-4AU, 3CS again leads the way this month and has rolled up a real list of DX worked. 3CM is busy working on a new plate transformer. 3DZ is having a real tussle with his tube trying to drag it down to 20 meters. 3AD would like schedules on 40. He is on steadily now and handling traffic. Central Dist: 3BL has at last got his N. E. 250 on the air and is getting out in good shape. 3DY has been on the 200 meter band a great deal this past month. 3EG has been prevented from hamming much because of business QRM. 3BL has been active as usual, but this month we have no details. 9AL started out with high hopes in the Tests, but we understand that difficulties cropped up and spoiled his fun. 9BJ has been operating regularly on 52.5 meters, and keeping schedules. 3FC came on once during the Tests and worked eg-5BY on 20 meters for an exchange of messages. 3DV has been experimenting with transmitting circuits, but finds the Hartley is best for him. 3DC has a new Belgian tube working in his CX set, 3AI has been having wonderful success on 80 meters, using a MG for plate supply. 3BT has been confining his attention to phone work and DX is lost in the "Vale of Despond". 3RU is a newcomer who is expected on the air very soon. 3DB is heard occasionally on 40 and 20. Eastern Dist: 3XM has had to go to Montreal in line of business but Mrs 3XM is now a full-fledged operator so she is carrying on his radio work at home. 3JW is planning a new station in a room donated for the purpose by the Blind Association of Ottawa, where he plans to be on the air very soon. 3MD has been on very little during the past month and 3XQ has been in Montreal for most of the month. Northern Dist: 3NI and 3HE are both on 52.5 meters regularly from their stations. 3FP pounds brass at every opportunity and can always be relied on to turn in a good traffic total.

Traffic: 9BJ 69, 3CJ 31, 9AL 53, 3DY 24, 9BJ 16, 3GN 10, 3FC 9, 3AI 9, 3DV 9, 3DC 9, 3IA 4, 3BT 4, 3AZ 4, 3EL 4, 3CB 2, 3CS 2.

QUEBEC DIVISION

QUEBEC—SCM, Alex Reid, 2BE—This month's Hamfest was held at station 2AD, a very enjoyable time being had by all. The movies of last summer's picnic was a great success and had to be repeated many times, also the Girl from France drew a great deal of attention from 2HV and 2BG. We wish to thank 2AD for the wonderful evening he gave the gang, and also 2AC for his donation of smokes. 2CA, our newest station, has already been QSO-eg-6RG. 2AX has added a new transmitter to his collection and worked five foreigners in one day. 2BR has added another 210 and also uses tube rectification. 2HV is QRW installing a number of emergency sets for his company. 2AD expects to be using fone on 20 meters soon. 2FO

QST FOR APRIL, 1928

has sold out his entire outfit, but still insists that he is not through with the game. 2AC is changing his set from YL to OW. Congratulations. 2BJ has been QSO England.

Traffic: 2BE 52, 2AL 17, 2BR 19, 2BB 13, 2BG 6.

YANALTA DIVISION

ALBERTA—SCM, A. H. Asmussen, 4GT—4AH after rebuilding, turned in a fine msg total due to having skeds in all directions. 4FF is second best and gets very good DX using two 201A's. 4CU is third and has worked some nice DX. 4FB is a new ham and turns in fourth best total. He lives in the country and without assistance built an xmitter using 201As and B batts. 4CC is getting out very well. 4GL is another new ham doing nice work. 4AF gets good reports on his fone from local BCLs. 4HM has rebuilt and it is the neatest and best in this section. 4HA has a very good antenna. 4GJ another new ham that may head the list as he is an old Morse opr. 4GD is in the radio business. 4AE, the Calgary Club station, together with the rest of the local stations report good results from their code practice skeds. 4BV is the new Secy. of the AREA.

Traffic: 4AH 66, 4FF 27, 4CU 22, 4FB 20, 4CC 16, 4GL 11, 4AF 9, 4HM 9, 4HA 6, 4GJ 5, 4GD 5.

BRITISH COLUMBIA—SCM, E. S. Brooks, 5BJ—5AL again enters the BPL with 60 deliveries. 5BL is a runner up and has skeds on 80. 5GO says 20 is FB and worked se-2AS in daylight. 5BR's total dropped this month on account of very few people on the island and it is hard to originate msgs. 5AD has a new ORS and is rebuilding for the spring rush. Hi. 9AJ tested out on the 14th and will be on regularly soon. The gang at 9AJ are going to build a new clubhouse. 5GF is all ready to bust ether again. 5CT is thinking of rebuilding again. 5CO says its hard to get skeds. 5AR contemplates going to Oregon. 5AT is still at 5AJ's key and is QSO OZ. The radio club of Victoria will be on soon with an H tube. 5CP still knocks 'em over. 5BJ is getting the shack fixed up.

Traffic: 5AL 83, 5BL 54, 5GO 45, 5BR 22, 5AD 14, 5CO 2.

PRAIRIE DIVISION

MANITOBA—SCM, D. B. Sinclair, 4FV—The only points made here during the Tests were 3 gained by 4FV when he clicked with oa-7CW. 4DU hooked nr-2EA but he QSSed out before messages could be exchanged. 4AW is on the road again so he is off the air indefinitely. 4DP actually handled some traffic. 4DW has been messing around with phone and reports working New York with it. 4GI has junked his low power 208A and now has 500 watts input to a 250. 4CT spends most of his time on 52.5 keeping a schedule with Red Lake. FB. 4EY has been up north installing transmitters so he has been QRT most of the month. 4FV is trying to keep a schedule with nr-VBY at Port Churchill on 52.5 meters but with out much success. 4GG blew about three sets of Kenotrons. 4MY now proudly signs 4GQ after his CQ's. Both 4GG and 4GQ put out a nice signal on 20. Any person who cannot get traffic on the air these days is not trying, and if he is not trying, he does not deserve an ORS. Also, if your fellows do not buck up on your reporting, there will be a lot of lost ORS certificates next month. This is just a word of warning, gang.

Traffic: 4DP 20, 4CT 18, 4EY 12, 4GG 5, 4GQ 8, 4FV 104.

SASKATCHEWAN—SCM, W. J. Pickering, 4FC—4HS has been appointed ORS but will be off for about three weeks studying and will be on later with more power and looking for traffic. 4CK sends in a picture of his shack. 4IH says he hears lots of oz and oa stations but can't connect. 4BM is still waiting to add the 1st and 5th Can. dists to his list. 4CB reports working VCB three weeks in succession. 4EV is having lots of fun with his low-power set but is getting out well. 4AV is off the air at present and is dabbling in the BC game. 4FH is on the air and getting out very well. 4FC has not been on very much having been busy building a new BC receiver. 4FK is at present operating 2-210s in the 80 meter band.

Traffic: 4HS 37, 4CK 23, 4IH 19, 4BM 9.



AUSTRALIA

We have recently received a copy of another magazine that is devoted in its entirety to amateur radio. "CQ" is issued by the New South Wales Radio Transmitters' League and distributed free to its members each month. No. 1 of Vol. 1 is a twelve-page brochure containing much in-

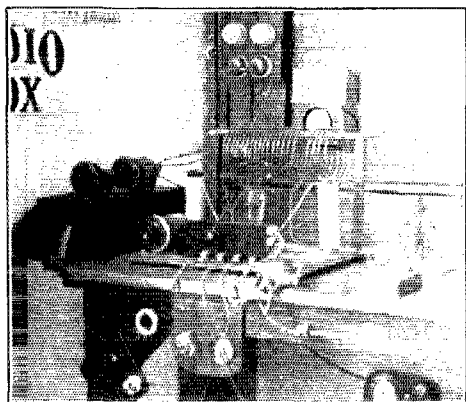

THE ABOVE PHOTOGRAPH SHOWS A VIEW OF 0a5DX LOCATED AT FORESTVILLE, SOUTH AUSTRALIA.

A single UX-210 is used in a loosely-coupled Hartley circuit. A step-up transformer and a 24-jar chemical rectifier supply about 18 watts of energy to the plate. Various antenna systems have been tried but, so far, a third harmonic affair has proven to be the best. A separate aerial is used for reception which allows break-in operation to be had at all times.

interesting material. Our best wishes for a long and active life go to "CQ" and the N. S. W. R. T. L., an organization that has added one more emblem in the form of a diamond to the long list already in existence.

"We have been alternating between very hot spells followed by copious rainfalls all over the eastern Australian states for the past couple of months and DX is patchy.

"During these last few weeks there has been a noticeable advent of European stations at around midnight our time. Signal

strengths have been quite good and many Australians have worked EG, EB and others. On the nights these stations have been heard well, I have noticed that low-powered outfits find it difficult to raise NU stations. I worked e11NO one night at midnight our time after vainly trying to raise some NU stations for half an hour.

"Signals from AC stations are coming in well but the AJ signals have not been heard for two months until last week. AI stations are now QSO Australians nightly and receive us mostly on indoor antennas which gives them a better signal static ratio. FO signals have been consistent for some months but are hard to raise owing to their habit of working each other after DX calls. Phone experiments have come strongly to the fore in all Australian states probably owing to the many spells of bad QRN and patchy DX.

"Short-wave sets are now being observed here and there on ships trading to Australia. Broadcast programs on short-waves have been exceptionally fine these last three months. The English station, 5SW, at Chelmsford has been relayed nightly by Australian 2FC and is well worth listening to.

"The matter of power as used by amateurs is an interesting study. Australians consider 100 watts as very big business indeed, the average man who works all continents being parked round about the 40-watt mark while the majority are using between 10 and 20 watts. It is cause for much comment when NU cards come in with descriptions of quarter-kilowatt tubes, etc. The favorite here is the 210 although a few of the high powered chaps are using the English T250. Many orders have already been placed for the UX-852 but, so far, only a few specimens are in operation. None has, as yet, reached Queensland."

—Russell F. Roberts, 0a4PN.

ENGLAND

"The following is some information on DX doings in England.

(Continued on Page 58)

Correspondence

The Publishers of QST assume no responsibility for statements made herein by correspondents.



"Calls Heard"

2940 Winchester Ave.
Ashland, Ky.

Editor, QST:

What we need is a new "Calls Heard" section. Give these birds who work in "no hams land" a chance to see their calls in print. Once should be enough to take the kick out of sneaking a call outside of the band or doing without a wavemeter of some sort.

During the last several years, I have noticed that there are quite a few hams that think that if their signals are not at the very bottom of the band that DX will be nil. Most of our wavemeters are none too accurate at the best so why take any chances on getting down to the exact bottom when a half a meter above it will be just as good and maybe a lot better for your hide.

Let everyone take it upon himself to be a cop of the air and make a list of all calls that are heard either below or above the band and save them for the infamous "Calls Heard" section. If you find your call listed in this section, don't be a sorehead but rather consider that someone has done you a favor (which it really is). Remember the Amateur Spirit!

—H. R. Lickens, 9ACS.

(Attached to this letter was a list of fifteen calls of stations operating off wave. All were heard more than once during one afternoon and evening. Would you like to see such lists?—Assist. Tech. Ed.)

Testing and Off Wave

40 Norfolk Road
Chestnut Hill
Brookline, Mass.

Editor, QST:

In connection with station operation there are two things in particular that we amateurs should concern ourselves with more than we seem to at present; namely, testing and off-band operation. Listen in any night around six o'clock and count the number of stations on the 40-meter band who are not working or calling, but just testing, making series of long dashes while, I suppose they see just how many tenths and a fraction thereof, register on their antenna ammeters or whether their "growler" gives them a steady note. Necessary? Possibly, but think of the suffering listeners and at least do that kind of testing out of busy hours. There are too many

times now when we hear that familiar remark, "sorry OM and QRM" without adding unnecessary QRM. I shudder to think what the reduced 40-meter band will sound like if this keeps on.

Off-band operation should be inexcusable. If a wavemeter cannot be bought for lack of funds, it costs little to make one accurate enough to assure operation within the allotted limits. The unfortunate part of it is that in most cases it is the newcomer who violates this regulation and does not realize how he may be spoiling foreign DX for someone else. Undoubtedly, he is blissfully unconscious of the fact that he is right on top of the foreigners who come in now just above and below our 40-meter band. The great majority of us are pretty careful about this but remember that the off-band station sticks out like a sore thumb and is a sure mark for criticism and worse.

Whenever I hear a station CQing above the 40-meter band where I listen frequently, I very often call him and tell him he's over the top and this is usually a sufficient hint for a rapid QSY. He gets no QSL card out of me, though, for that QSO although I do QSL all others 100%. Recently I did this to a "lid" station evidently with no result. I doubt if he could copy five per and for all I know may still be pounding away there on 45 meters blissfully unconscious of his error. For these kind we shed a bitter tear.

—Miles W. Weeks, n1lWV.

For 1929

105 South Marquette Street
Ironwood, Mich.

Editor, QST:

After reading the ins and outs of the Washington Radiotelegraphic Conference, especially with reference to the amateur and then reading comments on same in the succeeding issue of QST, I am prompted to express an opinion.

There is no doubt that we fared badly from the standpoint usually taken by the amateur but on the other hand, I hope that one distinct advantage will be made clear by the rules as laid down by the powers that be, and that will be that we will, in the future, have to have high efficiency transmitters operated with just as high a degree of intelligence if we expect to get results. It means that the day of the broad tuning, poorly adjusted transmitter with the sloppy wave is over. I further

AT LAST!

A Real Radiophone Transmitter —at a reasonable price!

*Employs
Low Power*

*Surprisingly
Long Range*

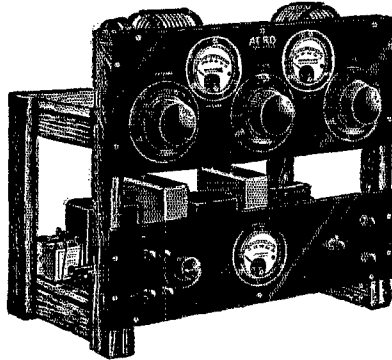

Easy to Build

Easy to Operate

*For All Low Wave
Work*

*The Aero Radiophone Transmitter
—Ready to Plug Into Electric Light Socket*

Here is a low power radiophone transmitter that every true radio fan will want to own. An extremely efficient circuit, designed by some of the best known parts manufacturers, that is producing wonderful records on the government licensed low wave bands. Simple to operate, easy to build, its cost is no more than that of a good broadcast receiver!

500 to 1000 Miles on Phone—Several Thousand Miles on Code

The New Aero Radiophone is a thoroughly tried and proved transmitter. As installed at station 9DBM, Chicago, the results on 20 meters have been remarkably good. Reports varying from R-5 to R-7 have been regularly received from these typical stations: 1BBM, North Harwich, Mass.; 1ASF, Medford, Mass.; 1SW, Andover, Mass.; 2BSC, Glen Head, N. Y.; 3AKS, Philadelphia; 3CE, Baltimore; 4MI, Asheville, N. C.; and 8CVJ, Auburn, N. Y. In every instance the quality of speech has been reported to be very fine.

Adapted to code work, the Aero Radiophone Transmitter has produced outstanding results. From a location not of the best, all U. S. districts have been worked with CW on the 40-meter band, as well as NC5ZZ, Vancouver, B. C.

Outstanding Performance Assured by Carefully Selected Parts

Only the best quality parts have been incorporated into the Aero Radiophone Transmitter. Products of the

following manufacturers—all with a national reputation—are specified exclusively:

Aero Products, Inc.,
Chicago, Ill.
Allen D. Cardwell Co.,
Brooklyn, N. Y.
Herbert H. Frost, Inc.,
Elkhart, Ind.

Polymet Mfg. Co.,
New York, N. Y.
Silver-Marshall, Inc.,
Chicago, Ill.

Tobe Deutschmann Co.,
Cambridge, Mass.
Yaxley Mfg. Co.,
Chicago, Ill.
Westinghouse-Micarta,
Chicago, Ill.

Investigate NOW—Write for FREE BOOKLET

The Aero Radiophone Transmitter is worthy of your careful investigation. Send your name and address at once for complete illustrated, descriptive literature showing schematics, and listing parts, prices, etc. Simply ask for Supplement A. Do it today, and learn how easily you can get into the fascinating field of radiophone transmission. Address

Aero Products Inc., Dept. 16R, 1772 Wilson Ave., Chicago, Ill.

NOTE *The parts for the Aero Radiophone Transmitter are standard parts and are available at all dealers—when completed is ready to plug into your electric light socket. All have been carefully chosen to give the maximum in transmitter performance. Complete drilled and engraved foundation units are also available.*

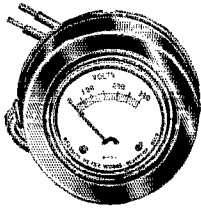

R. R. PANEL Radio Meters

R. R. Meters No. 346 with resistance of 1000 ohms per volt to measure "B" Eliminators, Bias Resistors and Batteries. They are accurate to 2½ per cent plus or minus.

No. 346

Cat. No. Type Price

Panel Voltmeters

| | | |
|---------|---|--------|
| No. 326 | For reading DC voltages, 0-6 volts | \$1.65 |
| No. 335 | For reading DC voltages, 0-8 volts | 1.65 |
| No. 310 | For reading DC voltages, 0-10 volts | 1.65 |
| No. 316 | For reading DC voltages, 0-16 volts | 1.65 |
| No. 337 | For reading DC voltages, 0-50 volts | 1.65 |
| No. 339 | For reading DC voltages, 0-100 volts | 1.75 |
| No. 342 | For reading DC voltages, 0-150 volts | 1.75 |
| No. 340 | For reading DC voltages, double reading, 0-8 volts, 0-100 volts | 2.25 |

Panel AC Voltmeters

| | | |
|---------|---------------------------|--------|
| No. 351 | For reading 0-15 volts AC | \$2.25 |
| No. 352 | For reading 0-10 volts AC | 2.25 |
| No. 353 | For reading 0-6 volts AC | 2.25 |

Panel Milliammeters

| | | |
|---------|-----------------------------------|--------|
| No. 311 | For reading 0-10 milliamperes DC | \$1.95 |
| No. 325 | For reading 0-25 milliamperes DC | 1.85 |
| No. 350 | For reading 0-50 milliamperes DC | 1.65 |
| No. 390 | For reading 0-100 milliamperes DC | 1.65 |
| No. 389 | For reading 0-300 milliamperes DC | 1.65 |
| No. 394 | For reading 0-400 milliamperes DC | 1.65 |

DC Pin Jack Voltmeters

| | | |
|---------|--|--------|
| No. 306 | For No. 25 and No. 28 Radiolas, 0-6 volts DC | \$2.50 |
| No. 308 | For No. 20 Radiola, 0-6 volts DC | 2.50 |
| No. 307 | Desk type voltmeter with cord, 0-6 volts DC | 2.50 |

Tube Checker

| | | |
|---------|--|--------|
| No. 210 | For experimenter, professional set builder, dealer and service man. Consists of 0-6 DC voltmeter, 0-10 DC milliammeter, grid bias switch, rheostat, socket and binding post, instruction sheet | \$6.50 |
|---------|--|--------|

Cord and Plug

| | | |
|--------|--|--------|
| No. 21 | for connecting meters in A and B leads of a receiver without any disconnections. Terminals correspond with posts on No. 210 tube checker | \$1.85 |
|--------|--|--------|

"B" Eliminator Meters

| | | |
|---------|--|--------|
| No. 346 | For testing B battery eliminators, grid bias voltage across resistors, batteries, etc.; 0-300 DC scale | \$4.50 |
| No. 347 | For same as No. 346, except scale is 0-500 | 5.50 |
| No. 348 | For testing AC current supply line, portable, 0-150 volts | 4.50 |

Write for Free Catalog

B. C. L. RADIO SERVICE CO., INC.
220 FULTON STREET, N. Y. C.

Please send at once your meters, catalogue numbers..... for which I will pay the postman the price as advertised in *QST*, plus a few cents extra for postage.

NAME

ADDRESS

CITY STATE

BRUNO 'Book of Hook-Ups,' 25 cents

believe that if every amateur should henceforth so adjust his transmitter that it send out a good, very sharp, clean cut wave, and of a good tone, we would find that we were not much more crowded in the forty-meter band than before. I certainly believe it is possible to find plenty of room for all in the wave bands given us under the new regulations if we go about it correctly.

Proceeding along this line, I am telling every operator with whom I communicate if his wave is broad and also anything else which happens to be the matter with his signals. In practically all cases so far where frank comment was given, it was taken in the constructive spirit in which it was given. Why can't all amateurs give a frank, yes, even hard-boiled criticism of the other fellow's signal? We all need it.

L. W. Van Slyck, 2EMB.

Ten Per

Duncan, B. C.
Canada.

Editor, *QST*:

I would like to add a few words to this "Beginner vs. Old-timer" controversy. It's all very well to say that we should help the beginners but when one has traffic to move or only a short time available to operate, "pse QRS" doesn't sound very encouraging.

Why don't those chaps Mr. Robbins mentions as being "barely able to get their ten per" stay off the air another month or so until they have had a little more code practice instead of cluttering up the air to no purpose and then kicking about the "speed demons." Where are these latter anyway? As far as I can see, the 25 to 30 word man is a scarce article in the amateur bands these days. I am afraid that conditions have changed in the other direction and the average amateur speed has deteriorated. That is why I disagree with Mr. Hanson as to the best way to treat the BCL who wants to "graduate." It is far better to help him a little in learning the code properly than to wait until he gets on the air and have to put up with his QRM and QRS.

Most of us have had experience with the two-faced type of BCL Mr. Hanson refers to. Surely, however, they are in the minority and we dodge more trouble by friendship in the BCL ranks than we incur in spite of such friendship.

W. F. Reeves, ne5CT.

Tangible Sympathy

P. O. Box 211
Boissevain
Manitoba, Canada

Editor, *QST*:

About ten months ago I became interested in amateur radio and since then have read each issue of *QST* from cover to cover. I note that there are some who feel that they have not been getting a square deal. Perhaps a few words concerning my own experience will help to give them a

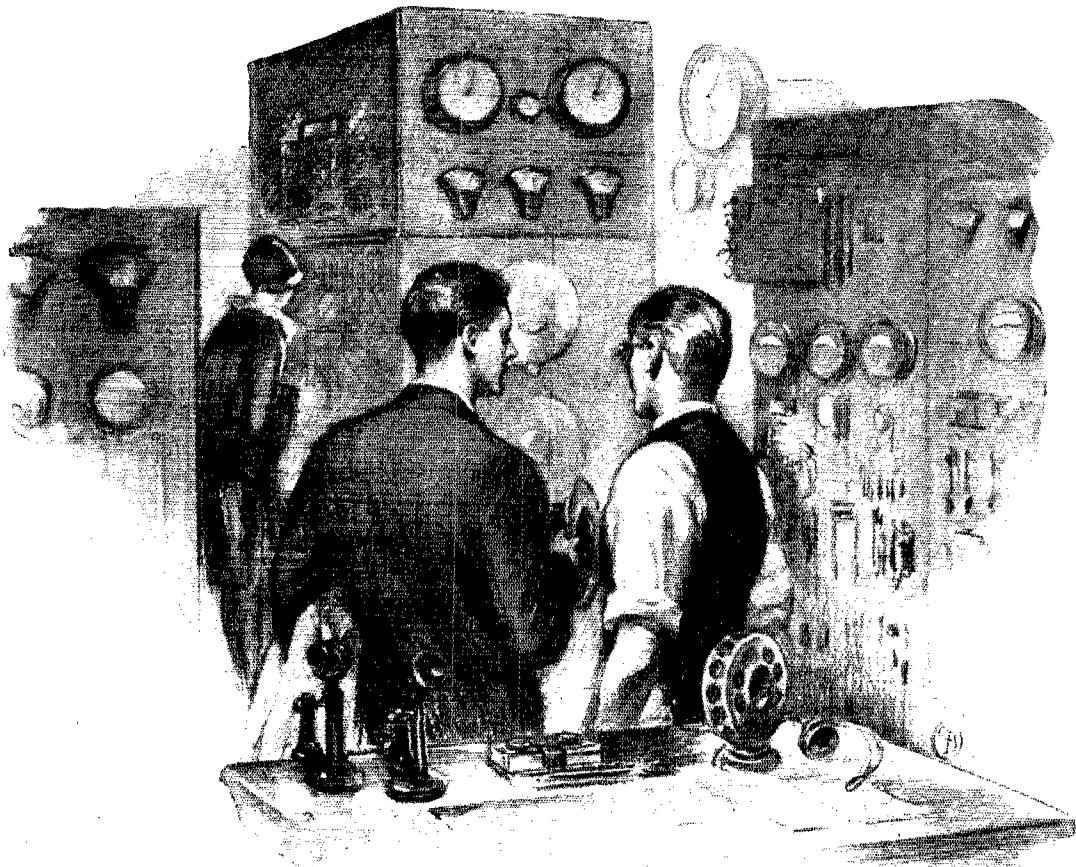

On the transmitting end—too

In the largest broadcasting stations of the country, in amateur transmitting and receiving sets as well as in high grade radio receivers for home use—you will find Faradon Capacitors the condensers of proven durability.

Twenty years of electrical engineering skill combined with highest quality materials have made Faradon Capacitors the standard of electrostatic condenser long life and reliability.

Faradon engineers stand ready to cooperate on special equipment which cannot be taken care of by the more than 200 types of Faradon Capacitors ready for prompt delivery.

**WIRELESS SPECIALTY
APPARATUS COMPANY**

Jamaica Plain : Boston, Mass., U. S. A.

Established 1907

*Electrostatic
Condensers
for all
purposes*

Faradon

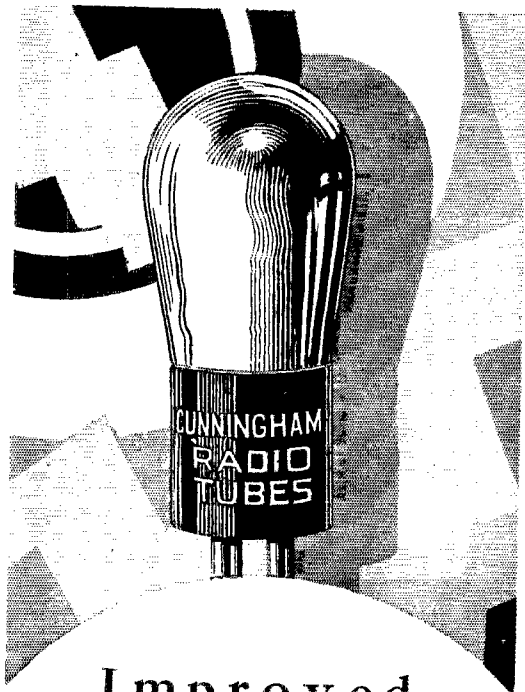

Improved Reception

There is marked improvement in your radio reception when new Cunningham Radio Tubes are performing their special tasks in the various sockets of your radio.

Don't use old tubes with new ones—use new Cunningham Tubes throughout.

E. T. Cunningham, Inc.
New York Chicago San Francisco

Cunningham

RADIO TUBES

better and brighter outlook on the matter. While I cannot handle much more than ten per as yet, I find that all the amateurs with whom I have clicked so far have been very patient. To my "QSC?" they would reply, "Keep at it OM, we all had to learn. Glad to click with you any time and glad to QSR." Do you blame me for feeling that they are all regular fellows?

Just a couple of days before Christmas, our home was gutted by fire and we lost everything even to our clothing which was rather hard on us because of the cold weather. Shortly afterwards we received a check from the Winnipeg Radio Traffic Association as a tangible expression of their sympathy. Is this not a combination of kindness and regular fellowship in the amateur world?

—Stuart R. Talbot, nc4AR.

Attention! Ocean-Hoppers

U. S. Military Academy
West Point, N. Y.

Editor, QST:

During 1928 there will undoubtedly be more trans-oceanic flights and the fliers will be torn between their need for radio and their desire to save weight. If they decide to take radio, and for their own safety they should, there will be further quandary: whether to use short waves or long.

Because the long waves around 600 meters are immediately picked up by surface ships, they are the most useful. That is, provided any ships are nearby. The

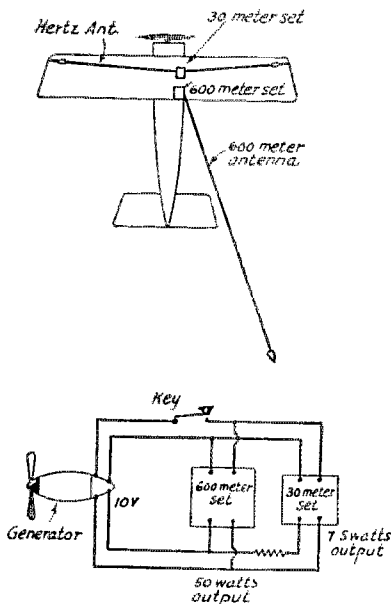

ocean is quite a large place and, off the main steamer tracks, surprisingly lonely. If the airplane gets into one of these blank spots, long-waves are of no avail.

For short-waves, on the other hand, the limits are much wider. Even a low-power

MORE SPECIAL OFFERS



UNI-RECTRON POWER AMPLIFIERS



MODEL AP-935

AS the Uni-Rectron stands it is a super power amplifier, which can be used in connection with any radio set and loud speaker. Binding posts are provided for input to the Uni-Rectron and output to the speaker. Requires no batteries for its operation. It obtains its power from the 110 Volt, 60 Cycle alternating current lighting circuit of your house.

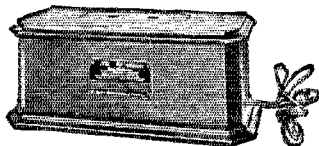

The UX-210 super power amplifying tube and the UX-216B or 281 rectifying tube are used with this amplifier, which cannot overload. From the faintest whisper to the loudest crash of sound—R.C.A. Uni-Rectron amplifies each note at its true value. High and low notes are all treated alike.

The volume and quality delivered will be a revelation.

Also by removing the input and output transformers it can be used as a source of power for an oscillating or transmitting tube, furnishing power for all circuits, grid, plate and filament and is the cheapest form of Power Supply for Amateur Transmitting purposes ever offered.

LIST PRICE \$88.50
(Without Tubes)

SPECIAL at \$19.⁷⁵ EA.

JEWELL HIGH RESISTANCE VOLTMETER

0-250 VOLTS D. C. (3 Readings)

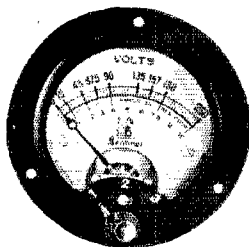

A high grade, accurate, reliable instrument.

Just what you want for checking the true operation of your "B" Eliminator or any source of plate voltage which cannot be obtained from ordinary low resistance type meters.

Can be permanently placed in the set which will enable the user to apply desired plate voltage accurately to each circuit of his receiver. By means of the front switch three readings can be obtained without disconnecting any wires, namely; the detector circuit, the radio frequency or intermediate circuit,

and the maximum or output circuit including last audio tube. Requires little current to operate due to its high internal resistance. Flush Panel Mounting. Zero Adjuster. *New and packed in original cartons.*

List \$22.00 Ea. SPECIAL at \$4.⁷⁵ EA.

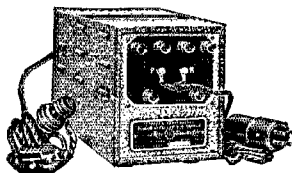

TIMMONS Combination Power Amplifier and "B" Supply

This high quality compact unit used a U. X. 216B or 281 tube for rectifying and a U. X. 210 super power audio tube as an amplifier which gives distortionless and true natural reception with wonderful tone quality and volume.

Besides being a super power amplifier this Combination also is a complete "B" Battery Eliminator furnishing all the "B" current required by the regular tubes of the set. No adjustments required and no output transformer or similar auxiliary equipments needed. For use with A. C. current 110 volt, 60 cycles.

They have been approved by Popular Radio and Popular Science Laboratories.

Every unit is new, packed in original factory sealed carton.

LIST \$70.00 EA.
(Without tubes)

PRICE ONLY \$23.⁵⁰ EA.



KENOTRON RECTIFYING TUBES

(TYPE T. B. 1)

MFD. BY GENERAL ELEC. CO.



These rectifying tubes operate on a filament voltage from 8 to 10 Volts and draw 1½ amps. They will safely stand an A.C. input voltage up to 750 Volts and pass plenty of current and voltage for the plate of the Transmitting Tubes.

They are also very efficient rectifiers for use in "B" Battery Eliminators.

STANDARD BASE
NEW IN ORIGINAL CARTONS

PRICE ONLY \$1.²⁵ EA.

AMERICAN SALES CO., 21 Warren St., New York City

TRANSMITTING TUBES

We rebuild them and guarantee them. We also guarantee that they will arrive to you from our Factory without damage. Special crates are the solution of the Problem.

We Build a 50-Watt Tube

Type 203, using a Tungsten filament at 10 Volts and normal plate current of 150 Mils at 1500 Volts on the plate. It is low priced at \$20.00.

We Make Rectobulbs

a hi-voltage Rectifier Tube—handles power up to 250-watt tubes—a small investment gives you a carefree plate supply—the note from the Rectobulb Rectifier is distinctive and pleasing and gets results—they handle 250 Mils at 3000 volts and have a UX base with plate Terminal on top end.

Also low priced at \$15.00 each (includes fuses)

We Produce Inductrons

a short wave coil—sealed in a Vacuum and with a UX base for plug in—simple, durable and efficient for your receiver: coil for each band at \$2.50 each.

WE REPAIR UV-203 at \$15

UV-204 at \$50

UV-203A (Tungsten Fil) \$19

UV-204A (Tungsten Fil) \$50

Water cooled Tubes and Rectifiers: ask for prices. All work Guaranteed against defects. No charge for Crates when cash accompanies order.

NATIONAL RADIO TUBE CO.

(6EX) 3420 18th St. San Francisco, Cal.

(A ham institution)

transmitter will carry across the Atlantic with R3 when a high-power outfit can only duplicate the performance with R6. And R3 is loud enough, if many people want to listen to it. A low-power short-wave transmitter aboard a trans-ocean plane will almost certainly be picked up by stations on both shores. But it will miss the nearby ships, if any, and landlubbers a thousand miles distant cannot do much about a plane down on the water.

The ideal system would be a combination of both long and short waves. Immediately the air-going brethren raise their eyebrows and say, "more weight." But very little more weight. Say that a fifty-watt set is going to be used on long waves. The generator must supply 150 to 200 watts of filament and plate power anyway. An extra 30 watts will not overload it. A simple but stable (large capacity across tube elements) 7.5-watt oscillator will weigh something like a gallon or two of gasoline, including its single wire Hertz antenna in the wings. As both transmitters run together and use the same key, there is no extra trouble in their operation. The diagram illustrates the essentials of the idea. I think it worth the serious consideration of anyone who contemplates flying an ocean this summer.

—William H. Wenstrom, 1st Lieut.,
Signal Corps. U. S. A.

Short Circuits

1001 East Main Street
Madison, Wisc.

Editor, *QST*:

I have recently made a discovery which I think should be passed along for the benefit of those who, like myself, wear metal-rimmed spectacles. Since being forced to wear them, I have had trouble in hearing DX signals. I now have discovered that my ears have been shorted out by the metal frames and that a piece of spaghetti over each of the ear hooks removes this difficulty and makes an efficient and low-loss pair of eye pieces. Of course, in some cases there is a high resistance short through the skull, but institutions are provided for such extreme cases.

—Don Mix.

Appreciative

Box 5
Niagara-on-the-Lake
Ontario, Canada

Editor, *QST*:

I am a beginner and wish to use this medium for expressing my thanks to all those who have been QSO nc3AY. Without an exception, these operators have been both courteous and willing to lend a helping hand.

Whether it is that the letters appearing in the "Correspondence" section of *QST* are having their effect or not we will probably never know but I must say right now that I have yet to meet a snobby operator.

—Albert Davey, nc3AY.

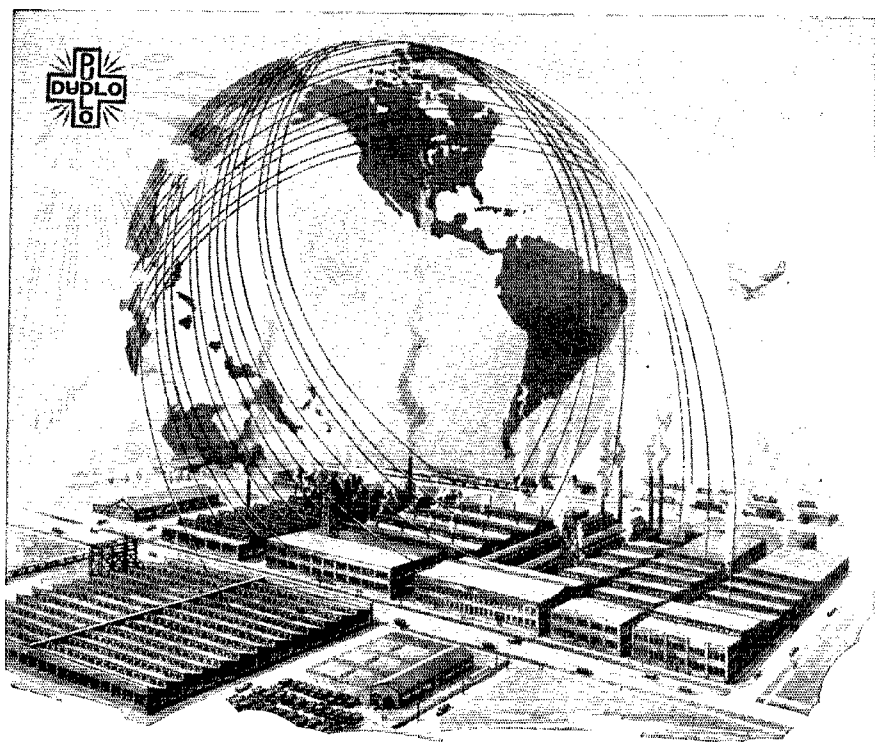

A World-Wide Service

Every civilized nation in the world uses products from
the Dudlo factories

MAGNET WIRE *and* COILS

made in this plant at Fort Wayne, Indiana, are built into electrical units employed in all forms of communication and transportation as well as in the thousands of electrical conveniences in modern homes and commercial buildings everywhere. The Dudlo insulated magnet wire produced in a single month would encircle the globe a hundred times.

Electrical and Radio Manufacturers may draw upon the broad experience gained from this international service by coming to Dudlo engineers for assistance on their wire and coil problems.

DUDLO

DUDLO MANUFACTURING COMPANY
FORT WAYNE, INDIANA

Division of the General Cable Corporation

56 EARL STREET
NEWARK, N. J.

160 NORTH LA SALLE STREET
CHICAGO, ILL.

4153 BINGHAM AVE.
ST. LOUIS, MO.

274 BRANNAN ST.
SAN FRANCISCO, CALIFORNIA

"World's Largest Radio Parts Plant"



NEW A Complete Line of SHORT WAVE PILOT Precision Equipment

COILS The most beautiful set of plug-in coils you've ever seen, with a method of mounting that saves space and makes wiring easy.

CONDENSERS New spaced-plate variable condensers for tuning, and regular types for oscillation control. Low-losses, precision construction.

MIDGETS Low-loss midget condensers in three sizes, for all tuning and circuit controls. Handsomest little midgets you've ever seen.

SOCKETS All types for all purposes. Finest designs and workmanship. Special types for all tubes.

DIALS Drum types with wheel or knob controls, illuminated vernier dials, and plain types. Most complete line ever offered.

RESISTANCES All values in rheostats, potentiometers and resistances, from 4 ohms to 3,000 ohms.

QUALITY These and the many other new PILOT parts are precision-made, of the finest materials, designed in accordance with latest scientific practice.

PRICES PILOT precision parts are amazingly low in price. Look at PILOT prices and you will see your radio dollar grow to a two-spot.

Send Stamp for Catalog

RADIO DESIGN QUARTERLY
103-Q BROADWAY, BROOKLYN, N.Y.

Special designs for new traffic receivers using Pilot short wave equipment, and broadcast sets with A. C. and battery tubes. All details, diagrams, beautiful photographs. Edited by M. B. Sleeper. SEND 25c FOR FOUR ISSUES. No extra charge for foreign countries.

Name
Street
City State

WNP

The Hotchkiss School
Lakeville, Conn.

Editor, *QST*:

I had the privilege of being a member of the Rawson-MacMillan-Field Museum Expedition in 1926 and again during the summer of 1927. As you probably know, Commander MacMillan and his men are now in Labrador for the winter.

During both summers that I was in the North your men did us all a very great service in making it possible for us to communicate almost regularly with our friends at home. Since my return I have received numerous messages from my shipmates who are now in the North through members of the American Radio Relay League.

I am writing to ask you to extend to those members of the League who have been so helpful to us my hearty thanks and appreciation of their kind and helpful service to us. I am sure that all the members of Captain MacMillan's crew feel the same appreciation.

With hearty good wishes to all the members of the American Radio Relay League.
—Joseph N. Field.

I. A. R. U. News

(Continued from Page 58)

"5HS has hooked up with foA3Z on 23 meters after trying for months. He is still working the fifth and sixth districts regularly. 2HK has now got a crystal set going and finds it FB. He has not much time to operate it, though. 5YK says he is working general tests with NU but cannot find any real DX on 23 nowadays. 5YX has been QSO foA3Z on 23 meters with ten watts input. He has now got a 32-meter permit and says NU is local. Other 23-meter stations who always seem to be QSO NU are 2BM, 2NH, 5BY, 6IA and 6VP. 2NH and 5BY also work on 45 meters a great deal as does 6RB who is working quite a few skeds with the U. S. A. 6QB-6LT has been raising 'em on both 23 and 45, his best DX being ne8WG in Hudson Bay while using only nine watts. FB! 2HJ managed to hook nu1AQT on 23 meters—his first and, so far, only NU. He has not yet gotten over the shock. The U. S. A. gang has been coming over on 40 very consistently but the 20-meter band seems dead all week although there are a good many on Sundays. There seems to have been a burst of activity among the Fos on 20 lately and A3Z is no longer the only one heard. However, there are very few stations in other DX countries that are audible. At a recent meeting of the R. S. G. B. we had the pleasure of a talk from xoa5MA who told of his adventurous trip on the *E. E. Sterling*.

"Just one other thing. I understand that there was a bunch of U. S. hams among

Your Sigs QSA

with

THORDARSON

TRANSMITTING EQUIPMENT

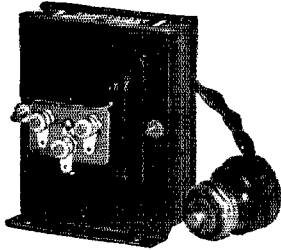

FILAMENT SUPPLY TRANSFORMERS

[Completely
Shielded]

- T-2180**—Secondary: 5 volts, center-tapped. Capacity: 15 V.A. Dimensions: 3½"x2¼"x3¼" high. Weight, 2½ lbs. Price \$5.00
- T-2230**—Secondary: 7.5 volts, center-tapped. Capacity: 35 V.A. Dimensions: 3½"x3"x3¾" high. Weight, 3½ lbs. Price \$7.50
- T-2382**—Secondary: 12 volts, center-tapped. Capacity: 80 V.A. Dimensions: 3½"x4½"x4" high. Weight, 5 lbs. Price \$10.00
- T-2383**—Secondary: 12 volts, center-tapped. Capacity: 175 V.A. Dimensions: 4½"x5"x6" high. Weight, 12 lbs. Price \$15.00
- T-2370**—Secondary: 1.25 volts, no center tap. Capacity: 20 V.A. Dimensions: 3"x2½"x3¾" high. Weight, 2¼ lbs. Price \$5.00
- T-2504**—Secondary: 3 volts, center-tapped. Capacity: 35 V.A. Dimensions: 3½"x3"x3¾" high. Weight, 3½ lbs. Price \$7.50
- T-2445**—Secondary No. 1: 1.5 volts, no center tap, 12 V.A. Secondary No. 2: 2.65 volts, center-tapped, 10 V.A. Secondary No. 3: 5 volts, center-tapped, 5 V.A. Dimensions: 2¾"x5¾"x4¾" high. Weight, 5½ lbs. Price \$10.00

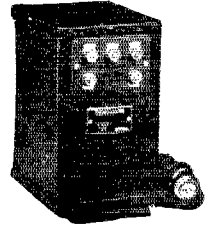

PLATE SUPPLY TRANSFORMERS

[Steel Case, Crackle
Finished, Compound
Filled]

- T-2385**—Secondary: 550 V. and 750 V. each side of center tap. Capacity: 100 V.A. Dimensions: 5"x5¼"x6" high. Weight, 8½ lbs. Price \$16.00
- T-2387**—Secondary: 1000 V. and 1500 V. each side of center tap. Capacity: 300 V.A. Dimensions: 7½"x5¾"x7½" high. Weight, 20 lbs. Price \$22.00
- T-2388**—Secondary: 1500 V. and 2000 V. each side of center tap. Capacity: 500 V.A. Dimensions: 7½"x6½"x8½" high. Weight, 27 lbs. Price \$30.00
- T-2389**—Secondary: 1500 V. and 2000 V. each side of center tap. Capacity: 1000 V.A. Dimensions: 7½"x7"x9½" high. Weight, 40 lbs. Price \$40.00

FILTER AND PLATE REACTORS

R-196—30 Henry, 80 M. A. 1000 V. insulation, shielded. Dimensions: 2½"x2½"x8" high. Weight, 2 lbs. Price \$5.00

T-2353—6 Henry, 150 M.A. 3000 V. insulation, open frame. Dimensions: 3"x3¼"x3¾" high. Weight, 3 lbs. Price \$7.50

T-2071—30 Henry, 150 M.A. 3000 V. insulation, open frame. Dimensions: 2¾"x3¼"x6" high. Weight, 5 lbs. Price \$16.00

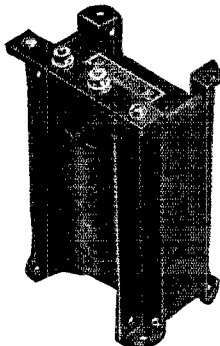

T-2027—30 Henry, 300 M.A. 3000 V. insulation, open frame. Dimensions: 5"x3½"x8" high. Weight, 14 lbs. Price \$22.00

T-2073—30 Henry, 500 M.A. 3000 V. insulation, open frame. Dimensions: 4¼"x5½"x9½" high. Weight, 24 lbs. Price \$30.00

T-2099—Double Filter Reactor, each reactor 30 Henry, 120 M. A. 1000 V. insulation, compound filled steel case. Dimensions: 3¼"x4¾"x5¾" high. Weight, 8 lbs. Price \$14.00

THORDARSON ELECTRIC MANUFACTURING CO.
Transformer specialists since 1895
WORLD'S OLDEST AND LARGEST EXCLUSIVE TRANSFORMER MAKERS
Chicago, U.S.A.

Achieve SUCCESS! in Radio

*Not by half-knowledge
—but by complete
thorough training*

**New course gives finest
instruction obtainable**

You Can Learn at Home!



R. L. DUNCAN,
Director,
Radio Institute
of America and
author of several
volumes on Radio.

Good pay from the start, rapid advancement, and phenomenal success—a life profession of fascinating brainwork—that is what Radio holds for the man who knows his subject *thoroughly*. Since 1909 Radio Institute of America has trained thousands to become successful in the many branches of Radio. Why don't you seize this opportunity to get into the commercial radio field where **REAL MONEY** is waiting for you?

New Course Finest Ever

Prominent radio men have enthusiastically greeted RIA's new course as the most complete and up-to-date offered today. A complete kit of first quality equipment is furnished **FREE WITH THE COURSE**—parts for making many practical radio circuits—the Peerless Signagraph and key and buzzer for code instruction.

**RIA backed by RCA, G-E
and Westinghouse**

You get all the benefits of instruction conducted by RCA and sponsored by RCA's associates, G-E and Westinghouse. Our employment department is at the service of graduates.

Study at Home!

Moreover you can **STUDY AT HOME**—when you please and as long as you please.

This new booklet describing the course is just off the press. If you want to learn more about the well paying positions in this fascinating profession send the coupon now for your copy.



RADIO INSTITUTE OF AMERICA
Dept. D-4 326 Broadway, New York City

RADIO INSTITUTE OF AMERICA Dept. D-4
326 Broadway, New York City

Dear Mr. Duncan:

Please send me your new catalog. I want to know more about your new radio course.

Name

Address

the American Legion crowd that was in London last September. How is it that none of these fellows turned up at the Second Annual Convention of the R. S. G. B. which took place on September 31st and October 1st? It really was very remiss of them not to come along, they would surely have been very welcome.

"Very kindest regards."

—K. E. Brian Jay, eg2HJ.

FRANCE

Mr. C. Conte whose regular list of "Calls Heard" appears elsewhere in this issue tells us that conditions during the month of January were favorable. Reception of signals from the U. S. A. was better than it has been in quite some time. Best conditions occurred on the 14th and 15th and R6 signals from 6AHP, 6BGH, 6CCL, 7DF, 7DL and 7GJ were the best that were heard. It is a very rare thing for him to receive signals from the sixth and seventh districts. This looks as though conditions were improving and that DX may be back again soon.

GERMANY

"During the past month conditions seemed to be more favorable here in Germany for European and DX work on the 40-meter band, whilst on 32 meters we noticed many dud nights.

"Concerning the Washington resolutions, we fear that the traffic in the band from 7,000 to 7,300 Kc. will be rather difficult to manage and we would propose that the 75

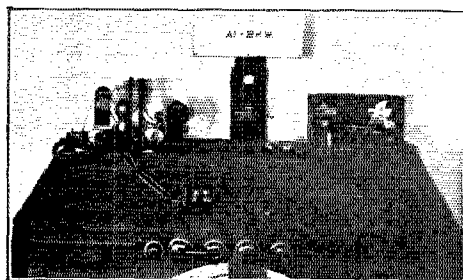

ai2KW HAS HELPED TO GET A WAC MEMBERSHIP FOR MORE THAN ONE NU AMATEUR SO A PICTURE OF THE "WORKS" BEHIND THAT CALL SHOULD BE OF INTEREST TO MOST.

The transmitter uses a 20-watt tube in a Hartley circuit. The input is normally about 60 watts and the reports are usually, "pure d. c." A half-wave voltage fed Hertz is connected directly to the oscillator inductance. The receiver is a O-V-2 affair employing capacitive control of oscillation. A separate antenna is used for it.

to 85-meter band which is now nearly abandoned for such be used for European night work. Night time DX work should be allowable in the 40-meter band while during daylight we could do our European work within these precious 300 Kc. In addition to work in these bands, strenuous efforts are necessary for the thorough investigation of conditions on 20 meters, at

Royal personages in China ride in a palanquin shielded from the public gaze.

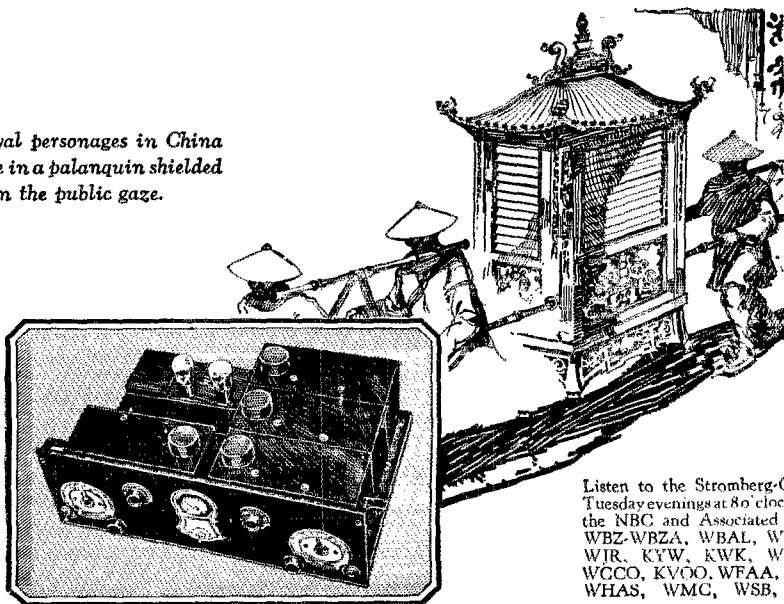

Listen to the Stromberg-Carlson Sextette Tuesday evenings at 8 o'clock E.S.T. through the NBC and Associated Stations: WJZ, WBZ-WBZA, WBAL, WHAM, KDKA, WIR, KYW, KWK, WREN, WTMJ, WCCO, KVOO, WFAA, KPRC, WOAI, WHAS, WMC, WSB, WBT, KOA.

TOTAL SHIELDING *protects* Stromberg-Carlson TONE

HOME from the theatre—with your companions of the evening! The realistic tone of the Stromberg-Carlson will bring you dance orchestras as though the players were in the same room.

The full beauty of Stromberg-Carlson's famous tone so admired and so envied, could never be attained without shielding—scientific "Total Shielding"—correct electrically and mechanically—shield-

ing designed by the pioneer manufacturers of shielded receivers. This shielding completely isolates each radio frequency and detector stages—allowing the building up of the enormous amplification needed for tonal exactness.

Music is reproduced as it was produced at the broadcasting studio—every original vibration, from lowest bass to highest treble overtone given its true timbre and value.

Your nearest Stromberg-Carlson dealer's address may be learned from his advertisements in your newspapers or in your telephone directory.

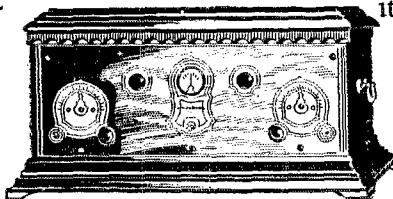

Stromberg-Carlson Receivers complete for A. C. house current operation, East of Rockies \$295 and up; Rockies and West \$315 and up; Canada \$365 and up.
No. 633 A. C. Stromberg-Carlson, illustrated.

Stromberg-Carlson Telephone Mfg. Co., Rochester, N.Y.

Stromberg-Carlson

MAKERS OF VOICE TRANSMISSION AND VOICE RECEPTION APPARATUS FOR MORE THAN THIRTY YEARS

Say You Saw It In QST—It Identifies You and Helps QST

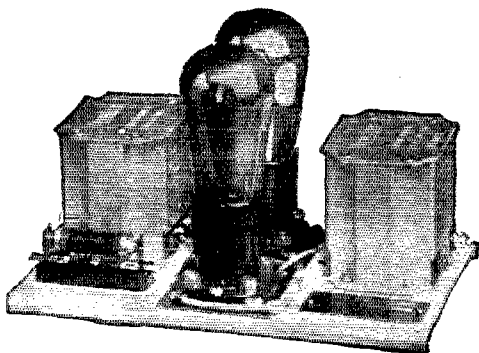

AmerTran Push-Pull Power Stage Type P—List price \$48 complete with two UX-171 tubes, \$54 with two UX-210 tubes. The unit is licensed under R. C. A. Patents and must be sold complete with tubes.

A Complete Push-Pull Power Stage

Increasing Clarity, Reality and Volume

Here is an AmerTran wired unit that meets the demand for a power stage that may be easily assembled in the average receiver.

It contains an AmerTran type 161 input transformer *wired to two power tube sockets, a 50,000 ohms mounted resistance, and an output transformer of the type required by the power tubes and speaker. AmerTran has considered all factors before offering this new power stage to the public, and that is the reason for the fine results obtainable. It is designed for specific tubes and speakers, and used as instructed, will produce a very high standard of performance.

For best tone quality, this power stage should be preceded by an AmerTran DeLuxe audio transformer, and the output connected to a high-grade speaker. The parts are firmly secured to a strong metal base, provided with mounting holes, and the whole unit is neatly finished. Complete information together with data on other AmerTran products will be gladly sent free on request.

**AmerTran Input and Output transformers have finest high permeability alloy core laminations and excellent frequency characteristics.*

American Transformer Co.

174 Emmet St., Newark, N. J.

Chicago, Illinois, AmerTran Sales Co., 53 West Jackson Blvd. Cambridge, Mass., AmerTran Sales Co., 552 Massachusetts Ave. Pittsburgh, Pa., Herr-Harris Co., 910 Fulton Building. San Francisco, Cal., W. I. Otis, 905 Mission Street.

"Transformer Builders for Over 28 Years"

the same time not neglecting the new 10-meter band that deserves special attention.

"It might be of interest to many to know that three Munich amateurs are about to begin experiments in the use of picture telegraphy on short waves. They suppose that they will be able to transmit their QSL cards to any amateur who is in a position to receive and interpret their signals which employ the Dieckmann system. Anyone interested in the matter is requested to write to ek4UAH directly or through the QSL Section, D. F. T. V., Berlin W. 57, Blumenthalstrasse 19.

"Some of the Hamburg amateurs are busy grinding their own quartz crystals. Quite good success has been obtained generally and interest in this work is increasing every day, newcomers this month being 4ABI and 4AN.

"We wish the three London amateurs the best of success in their tests on skip distance and wish to say that we are always ready and pleased to cooperate with all OMs abroad arranging schedules for experimental or scientific work."

—D. F. T. V.

NORTHERN IRELAND

"DX conditions generally seem to have improved and become more stable during the last month. NU signals come through well on most nights and the 20-meter band seems to be regaining its popularity. The South American stations are also starting to come in well between 30 and 40 meters and the South Africans are sometimes very good on the 20-meter band. Conditions concerning India and the Far East have been improving since December.

"6YW has been doing excellent work on 32 meters with very low power and a badly screened aerial. His DX includes nx1XL, (on 45 meters) AWL in the Mediterranean, AQS in the Arctic, aq1LM at Baghdad as well as a report of being called by nu8BPQ. 6WG has been working NU stations regularly with about ten watts input which is obtained from a hand-driven generator. 5WD has made a good start from his new QRA which is 6 Springmount, Captain Street, Coleraine, N. I. He, also, is using a hand-driven generator to supply power to his transmitter which is on 45 meters.

"There has been much good work done by the other low-powered stations but most of them find it difficult to attract attention from the NU stations when working on 45 meters. 6MU has been working ai2KX regularly on schedule and conditions have improved sufficiently to allow occasional phone work to be accomplished. It is expected that 2KX will come home to England during April. 2IT is working occasionally on 21.5 meters and is always QSA in the U. S. A."

—E. Megaw, gi6MU.

IRISH FREE STATE

"The Wireless Society's station signing gw12B has been doing good work lately,

32 Pages Bigger!

THE new edition of the RADIO AMATEUR'S HANDBOOK has 32 pages more than the last edition. That's because additional information has been inserted in all parts of the book and everything has been brought right up to date. Two hundred and sixty-six pages of dope, data and details—all for one dollar, postpaid anywhere.

OF course you can struggle along with the old edition—or it's even possible that you can do without the Handbook entirely—but why handicap yourself when it costs only a dollar to have the new Handbook in reach whenever you need some radio information?

*This is
easier than
writing a
letter* →

AMERICAN RADIO RELAY LEAGUE,
Hartford, Conn.

Here's my dollar—you know what I want.

Name.....

Address

JUST OUT!

See it For 10 Days FREE

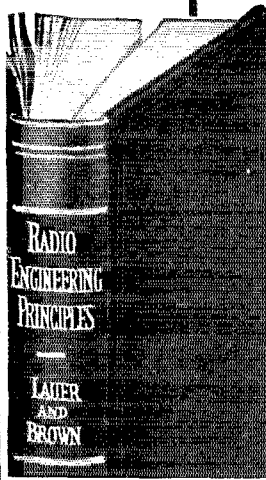

Four Good Reasons Why You Will Want to Examine This New Second Edition of **Lauer & Brown's**

RADIO ENGINEERING PRINCIPLES

301 pages, 6x9, 227 Illustrations
\$3.50 net, postpaid

1. The book covers in detail the science and practice surrounding the 3-electrode vacuum tube;
2. It gives the principles involved in the functioning of all forms of radio apparatus;
3. In the development of principles, the electron theory is made use of;
4. Mechanical analysis are avoided—Mathematics is used only to indicate applications in problems of design.

This standard manual gives the latest and best basic data on all phases.

Some of the Topics

- radio-telegraphic transmitting circuits;
- ferro-magnetic or detuning modulation methods;
- mathematical theory of the balanced modulator;
- piezo-electric oscillators and resonators;
- etc., etc., etc.

having made contacts with stations in the 1st, 2d, 3d and 8th NU districts on a wave of 45 meters. A loosely coupled Hartley transmitter feeding a third harmonic inverted "L" antenna is used. Its plate supply comes from a 500-volt battery-driven dynamotor and the input is normally 10 watts.

"The station of the Grenfell Mission at St. Anthony, Newfoundland, ne8AE, has been worked on 45 meters with an input of between nine and ten watts. A schedule has been arranged between these two stations.

"Excellent DX conditions have prevailed on the band between 40 and 45 meters during the first half of January, stations in the 4th, 5th and 9th NU districts having been heard with signal strengths up to R7 between midnight and 0100 G. C. T. using a O-V-1 Reinartz receiver. We wonder why these stations never seem to call, "Europe" or even "DX." nu1BQT was worked as early as 2140 G. C. T. and from this time onward, signals from NU stations have been arriving in Dublin at fair strengths.

"Gw18B has been keeping his schedule with nx1XL in spite of terribly hard luck with his hand generator which has burned out repeatedly of late. He has also worked ne8AE, aaYX1 and a Canadian, all on the 45-meter wave.

"Gw17C has worked Egypt, FI, AG and Aq stations on 45 meters as well as WNP on 23. 11D continues to increase an already big list on NU stations in the 20-meter band. His best, so far, is a ninth district station.

"11B has been cutting some fine crystals and although he reports but very little transmitting activity, we have heard nu1BFK calling him on 40 meters. There seems to be but little work being done among other stations with the 20-meter band being the quietest. It is expected that 12B will be active on 23-meters shortly and will, of course, be seeking tests with NU, NC, etc."

—H. Hodgens, Hon., Sec.,
Wireless Society of Ireland.

ITALY

"Italian amateurs have been particularly busy during the month of January in their experiments with phone transmission on the 45-meter band. Almost every day at 1300 G. C. T. some fifteen of our stations located in all parts of Italy are carrying on friendly phone conversations. Remarkable results have been obtained with very low power by 1AS, 1AM, 1BS, 1DY, 1SA, 1GN, 1NO and 1MA.

"Special experiments on duplex telephony were carried on between 1GN, 1FP and 1AM and the results obtained were excellent. 1NO did some good DX work with fqPM, xep1MA at China and the Zikawei Observatory station at Shanghai operating on 24 meters.

"We are extremely interested in the International Tests to be run in February

McGraw-Hill FREE EXAMINATION COUPON

McGraw-Hill Book Co., Inc.,
370 Seventh Avenue,
New York, N. Y.

You may send me Lauer and Brown's RADIO ENGINEERING PRINCIPLES—New Second Edition, \$3.50 net, postpaid. I will either return the book, postage prepaid, in 10 days, or remit for it at that time.

Name
St. & No.
City
State
Name of Employer
Official Position
(Books sent on approval in the U. S. and Canada only.) QST, 4-1-28

DODGE RADIO SHORTKUT

With Appendix and Hints for Better Key Work. Fixes Signals in mind to stick—Kills Hesitation, Cultivates Speed and Good Fists—Produces Results. Slow Hams raise speed to 25 per in few evenings. Previous Failures quality and pass exam quickly. Beginners master code and pass in ten days.

DODGE HIGH SPEED METHOD

(Intensive Speed Practice)

Quickly puts 25 per Hams in 35-40 per class. Five Hams report made this gain in few evenings. One of them by 75 minutes total practice only.

DODGE MORSE SHORTKUT

Easily mastered by Radio Ops—Kills tendency to mixup or confusion. Either code used as desired.

REPORTS FROM USERS

Tell the complete story—Mailed on request. Radio \$3.50. High Speed \$2.50. Morse \$2.50. Money order. None C. O. D. Foreign add 50 cents.

C. K. DODGE, MAMARONECK, NEW YORK.

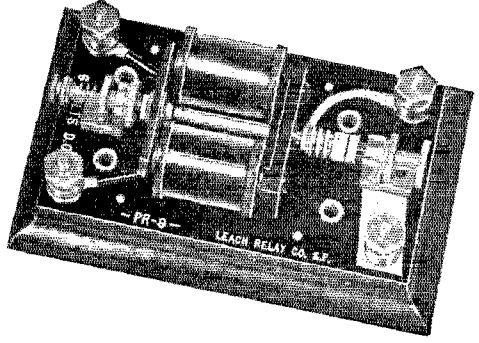
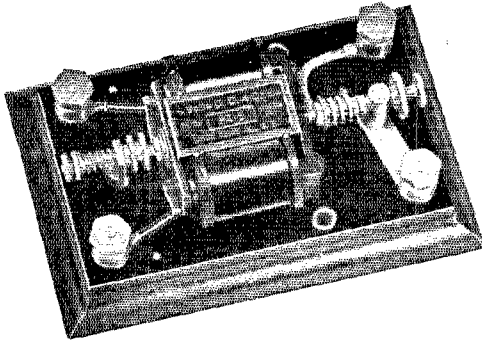

NEW RELAYS for your Transmitter

PR-5

Operates on 6 volts D.C. adjustable to all positions. 1/4" pure silver contacts. Lacquered brass finish. 3 x 5 1/4" x 1/4" Bakelite base. Maple sub-base. Recommended for 250 watts or less.

PRICE \$9.00

PR-9

Operates on 6 volts D.C. Adjustable to all positions. 3/8" pure silver contacts. Highly polished nickel finish. Engraved Bakelite base. Maple sub-base. Recommended for 250 watts or over.

PRICE \$12.00

THESE RELAYS ARE EXTREMELY FAST. THEY DO NOT LAG NOR DRAG.
MADE BY MAKERS OF THE FAMOUS "LEACH BREAK-IN RELAY"

LEACH RELAY COMPANY

693 MISSION STREET

SAN FRANCISCO, CALIFORNIA

DEPENDABLE! EVERLASTING! "B" BATTERY POWER

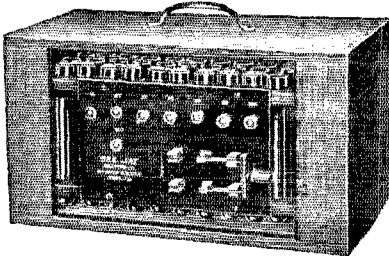

100 VOLT EDISON ELEMENT, NON-DESTRUCTIVE RECHARGEABLE "B" BATTERY WITH CHARGER
Shipped dry with solution \$12.00
140 VOLT WITH CHARGER \$17.00
100 Volt POWER UNIT with TUBE \$16.00
Free Sample Cell. See how it operates. A Sample of Perfection. Complete knockdown batteries all sizes at **REDUCED PRICES.**

180 Volt UNITS built to your specifications.
SEND NO MONEY—PAY EXPRESSMAN
Write for Free Illustrated 24 Page Booklet.

SEE JAY BATTERY COMPANY
915 BROOK AVE. Dept. A, NEW YORK CITY

YAXLEY

APPROVED RADIO PRODUCTS

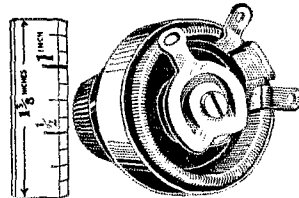

Junior Rheostat

A Junior Rheostat made to a standard. The most rugged and dependable design and material. Large radiating surface. Smooth operation. Furnished in all sizes in both rheostat and potentiometer.

Rheostats 75c each
Potentiometers to 400 ohms \$1.00 each
Switches, furnished separately, fit all Yaxley Junior Rheostats and Potentiometers 40c each

At Your Dealer's
Yaxley Mfg. Company
Dept. Q, 9 So. Clinton St. Chicago, Ill.

SPECIAL TO AMATEURS

Barawik's new amateur dept has everything that amateurs desire. The Barawik Radio Guide gives full details. Send for it.

FREE RADIO GUIDE

RADIO BARGAINS
Shows the latest wrinkles, newest developments in radio at startlingly low prices. Get the set you want here and save up to 50%. The best in parts kits complete factory-built sets and supplies. Orders filled same day received. Write for free 164-page copy NOW; Wholesale prices to dealers.
BARAWIK CO., 129 N. JEFFERSON DEPT 411, CHICAGO, U.S.A.



with
2GNM
for HAM PARTS
Pilot Short Wave Plug-in Coils
Range 20 to 200 meters



Coils are wound with No. 16 wire spaced the diameter of wire and wound on a thin celluloid form. The form touches the wire only at the extreme bottom insuring firm support and low dielectric losses

Coils with mounting and hook up ready to use, \$4.50

QSB? FLETHEIM FILTER CONDENSERS
Equipped with porcelain insulated terminals.

| | 1000 volts | 2000 volts |
|-------------|------------|------------|
| 1 mfd. | \$1.69 | \$2.39 |
| 2 mfd. | 2.39 | 4.09 |
| 4 mfd. | 4.19 | 6.59 |

SANGAMO .092 Mfd. 5000 volt Blocking Condenser \$1.49
AERO SHORT WAVE TRANSMITTING INDUCTANCES
20-40-80 Meter Coil Kits \$9.29
AERO SHORT WAVE RECEIVER TUNE COILS
13-130 Meters \$7.95
THORNTON POWER TRANSFORMERS (all sizes)
Type 2298 550 volts each side of center tap with two
7 1/2 volt 2 1/2 ampere filament windings. Eb for a 210
oscillator \$13.75

ELECTRAD WIRE WOUND RESISTANCES

| | 25 watt | 50 watt | 75 watt |
|-------------------|---------|---------|---------|
| 5,000 ohms | \$.69 | \$1.19 | 1.49 |
| 10,000 ohms | .85 | 1.39 | 1.98 |
| 20,000 ohms | | 1.49 | 1.98 |

Resistances with center tap 10% extra. All resistances in stock including 75 watt type. These resistances are Eb for gridleaks. 20% discount on all sizes.

Acme No. 12 solid copper enameled wire. Most efficient for short wave antennas.

CUNNINGHAM CX322 SHIELDED GRID TUBES \$5.45
Tyrman Tube Shields with Sockets for the SG Tube .58

EVERYTHING IN HAM PARTS
Full line Weston DC and AC Meters at 10% discount
MAIL ORDERS GIVEN IMMEDIATE ATTENTION
Lets Hr Ur troubles Om RADIO 2GNM

FANMILL
FANMILL RADIO CO. INC.
62 CORTLANDT ST.
New York City
A Safe Place to Buy Radio

and it is expected that quite a number of EI stations will participate."

—F. Pugliese, ei1FP,
Sec. Italian I. A. R. U. Section.

SOUTH AFRICA

"The South African Radio Relay League has been requested by the Postmaster General to put forward suggestions for a scheme to assist the Minister of Defense in providing Africa with a secondary means of radio communication in the event of trouble or disaster. A special committee at headquarters has been formed and is actively engaged in drawing up a scheme along the lines of the A. R. R. L. Official Relay Stations for submission to the South African government. As this has been one of our strong desires ever since the inception of our organization, we are, naturally, very happy over this turn of events.

"DX conditions have been excellent, being at their best around 1700 G. C. T. Boyce of A7A reports contacts with ai2KT, ai2KW, oa5CM and oa2YL. 20-meter transmissions are coming through well with such stations as ai2KT, af1B, eg5ML, nu1SZ, 1ASM, 1BW and 8CFR being heard most consistently.

"The accompanying photo is of foA3Z, the station operated by OM Hill at Port Elizabeth. The transmitter employs a 203-A tube in a tuned-plate tuned-grid cir-

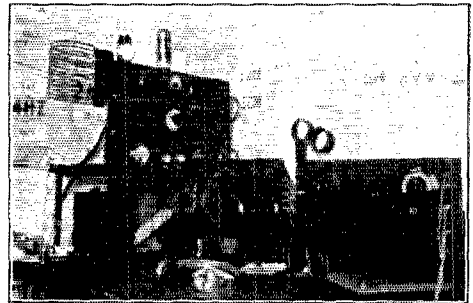

foA3Z

A New and Improved Volume Control for "AC" Circuits

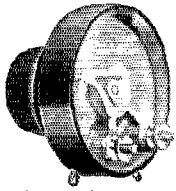

Centralab Radiohms RX-100 and RX-025 have been built with exact taper of resistance to give effectual control of volume smoothly, without jumps and sudden blasts.

When the RX-100 is placed across the secondary of one of the R. F. stages it surely and positively controls the volume from a whisper to maximum on all signals—powerful locals notwithstanding. This Radiohm will also control oscillation very effectively.

The RX-025 has the exact taper of resistance for a volume control when placed in the antenna circuit, or across the primary of an R. F. transformer.

One of these two Radiohms and the Centralab Power Rheostat are essential resistances for all "AC" circuits. They help to maintain the delicate balance of voltages throughout the circuit and in no way affect the balance between plate and filament current, so necessary to maximum efficiency.

Write for new folder
showing applications

Central Radio Laboratories
20 Keefe Ave. - - Milwaukee, Wis.

Centralab

cuit. The plate supply is obtained from a home-made transformer, the output of which goes through a chemical rectifier and filter circuit. The voltage applied to the plate is about 1200 and the normal plate current is around 140 ma.

"The power and filament transformer and rectifier are mounted under the operating table together with the A and B batteries for the receiver. The antenna which is used for both transmitting and receiving is of the inverted "L" type, 95 feet long supported between two 50-foot masts. A 5-wire fan counterpoise is used. The receiver next to the transmitter is a short-wave O-V-1 affair and the one to its right is a five-tube BC set.

All continents have been worked by A3Z who has 26 different countries to his credit.

VITROHM Transmitting Grid Leaks and Rheostats now cover the entire line of transmitting tube circuits. ¶The prices on these amateur products are reduced materially. ¶Your dealer should stock Vitrohm Transmitting Products. ¶If you have difficulty in obtaining them, write us direct.

| CATALOGUE NUMBER | PRODUCT | RESISTANCE | DISSIPATION | CURRENT | MAX. TUBE RATING | PRICE |
|------------------|-------------|-------------|-------------|----------|------------------|--------|
| 507-2 | Grid Leak* | 5000 ohms | 44 watts | 90 m.a. | 100 watts | \$2.00 |
| 507-3 | Grid Leak* | 5000 ohms | 200 watts | 200 m.a. | 1000 watts | 2.80 |
| 507-4 | Grid Leak† | 50,000 ohms | 200 watts | 60 m.a. | 1000 watts | 6.50 |
| 507-5 | Grid Leak† | 20,000 ohms | 200 watts | 100 m.a. | 1000 watts | 4.25 |
| 507-51† | Grid Leak* | 10,000 ohms | 200 watts | 135 m.a. | 1000 watts | 4.00 |
| 507-66 | Grid Leak** | 15,000 ohms | 200 watts | 120 m.a. | 1000 watts | 6.00 |
| 507-63 | Rheostat†* | 50 ohms | 50 watts | 1 amp. | | 5.50 |
| 507-59 *** | Rheostat*† | 20 ohms | 80 watts | 2 amp. | | 5.50 |
| 507-83 | Rheostat*† | 12.5 ohms | 60 watts | 2.2 amp. | | 5.50 |

* Center-tapped

† DeForest P or R. C. A. 852 Tube

De Forest H Tube

** Steps at 5M—10M—15M

for R. C. A. 852 or DeForest P Tube

† For Primary Control

*† Filament and Primary Control

Ward Leonard Electric Company

37-41 South Street

Mount Vernon, N. Y.

Master the Code

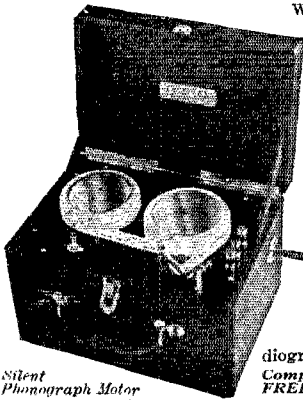

Wireless or Morse quickly at home with The

TELEPLEX

Code Instructor
No better method for self-instruction exists. *Quick-Easy - Thorough.* Endorsed by U. S. Navy and leading Technical and Telegraph Schools. The only instrument that **KE-PRODUCES** actual sending of expert operators. Sends messages, radiograms, etc. Any speed. **Complete course (6 tapes) FREE. 30 times as many**

Silent Phonograph Motor

words as any other instrument. Tapes cannot be memorized. Last indefinitely. Avail yourself of the TELEPLEX for a quick mastery of the code. Write for booklet RL.

TELEPLEX CO., 76 Cortlandt St., New York

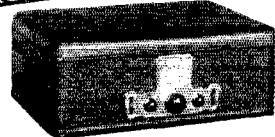
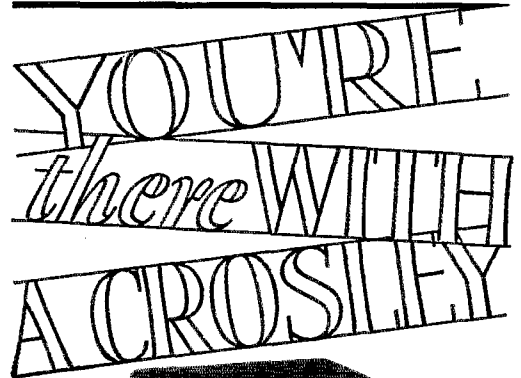

THE NEW CROSLEY JEWEL BOX

Genuine neodyne A receiver. 180 volts on plate of last tube gives full natural tone. Very sharp and selective. Write Dept. 18 for information

THE CROSLEY RADIO CORPORATION

Powel Crosley, Jr., Pres. Cincinnati, Ohio

Licensed only for Radio Amateur, Experimental and Broadcast Reception. Prices slightly higher in far western states.

Battery Type Bandbox, \$55
Dry Cell Bandbox, Jr., \$35

\$95.00

Power Tube Work

REPAIRING AND REEXHAUSTING OF ALL SIZE TRANSMITTING TUBES
PRICES UPON APPLICATION

Glenwood Laboratories

142 Market St. Newark, N. J.

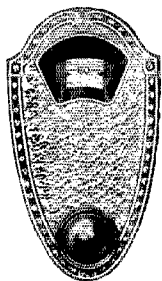

**NOW—
A Single
Drum Dial
by
National Co.**

New in design but with the familiar NATIONAL Qualities; famous Velvet-Vernier Tuning, and made to Use and to last. 360 degree motion allows attachment to all types of variable condensers.

Smaller Drum, with automatic take-up permits high position of sub-panel without cutting. Visible portion of dial inclined upward for easier reading.

Easily attached. Ask for type F—price, \$4.00. Type 23 Illuminator, 50c.

NATIONAL

TYPE F ILLUMINATED VELVET VERNIER DIAL
NATIONAL COMPANY, Inc. Malden, Mass.
W. A. Ready, President

He has won the S. A. R. L. trophy for the second time in the recent competition for it which is confined to stations in South Africa."

F. P. Marks, foA5F.

NEW QRAS

agRIL—Georgia Tifis Navtlug, Radio RIL, U. S. S. R. (by D. S. Hutchinson.)

auRABS—Tachkent, Turkestan. (eb4ZZ.)
WWD—St. George Island, Pribilof Ids. off Alaska. (nc5AW.)

nr2FG—Frederico Gonzalez, Box 384, San Jose, Costa Rica.

Calls Heard

(Continued from Page 58)

J. Bernfield, 14 Richmond Road, Wimbledon, London, S. W. 29, England.

1c1o 1bcw 1uw 1mv 1ahi 1cmx 1bjk 1bux 1adm
1bbm 1ajm 1aot 1ia 1vw 1bgl 1aoh 1a1r 1lv
1cmf 1azw 1asi 1lj 1cue 1ctu 1cpb 1asu 1aep 1byv
1aff 1akz 1ajh 1dm 1cjh 1ach 1ii 1ccz 1ben 1bgc
1xv 1apy 1aal 1qi 1ue 1fl 1anv 1gc 1vc 1ckk 1aba
1sz 1uz 1beb 1awe 1ff 1bgt 1kl 1ag 1cx 1abd 1bkr
1awm 1ahx 1ic 1ow 2cuz 2jn 2bbe 2apa 2aol 2mb 2px
2cc 2bdk 2cns 2bmr 2ags 2ahm 2amd 2au 2sy 2or 2pq
2aol 2aef 2cvj 2hv 2nm 2asc 2uo 2aib 2ada 2avb
2aue 2awx 2awq 2bda 2ahi 2cwm 2ih 2avw 2md 2bmr
2dr 2ayj 2amj 2eyx 2bck 2bad 2avr 2bum 2buy 2erb
2ow 2btq 2lw 2cc 2ceb 2ag 2sz 2gp 2mv 2di 2bgg
2pr 2hu 2buz 2nz 2qe 2aks 2bms 2ax 2gi 2aim 2dd
2qb 2ll 2hx 2ej 2xe 2pi 2aar 2af 2ju 2fv 2iz 2rq 2it
2ben 2ahe 2aly 2cmb 2axk 2afq 2evs 2alu 2cmg
2axn 2azg 2vx 2bni 2aj 2aga 2atv 2cip 2ces 2bas 2ske
2cae 2dae 2li 2cin 2cdf 2bwa 2ces 2ecq 2arg 2akg
2dgp 2scf.

G. D. Pine, 15 Hillside Avenue, Exeter, Devon, England

1aac 1aao 1abd 1abn 1acu 1adm 1ads 1aep 1ag
1ahv 1air 1a1s 1a1r 1am 1am 1anz 1aow 1ap 1ara
1ary 1ask 1asu 1atg 1au 1aur 1avf 1avl 1aw 1awe
1axa 1axx 1az 1azd 1azi 1azw 1bat 1bdi 1bed 1bex
1bez 1bgq 1bkr 1bux 1bv 1bw 1cd 1cjc 1ckp 1cmf
1cmp 1cmz 1cpe 1ere 1df 1di 1dm 1ev 1fl 1fm 1fn
1ga 1gh 1gi 1ic 1id 1ja 1jb 1jz 1kh 1kk 1le 1lj
1lt 1lu 1lx 1mn 1mo 1mr 1mv 1my 1nl 1nq 1qc
1ql 1rd 1rn 1ry 1se 1sk 1sw 1sz 1ud 1uw 1uz 1vz
1wz 1xaw 1xi 1xm 1xy 1yb 1zd 1za 2abf 2abg
2abp 2acu 2adl 2af 2afv 2ag 2ags 2agn 2agq 2ags
2agw 2ahb 2ahg 2ahm 2aib 2aia 2akx 2alu 2alv
2amf 2amg 2amh 2amj 2amn 2ano 2anz 2apb 2apd
2api 2apn 2aqw 2ard 2ary 2as 2ass 2atk 2atq
2atz 2aul 2aun 2avb 2avq 2avv 2avw 2awb 2awq
2ay 2aya 2ayj 2az 2bac 2bad 2bav 2baz 2bbc 2bbx
2bcb 2bcc 2bch 2bez 2bdc 2bhd 2bdi 2bek 2bew 2bfj
2bfq 2bgc 2bgt 2bj 2bmf 2bms 2bow 2box 2bs 2bsc
2bsl 2bua 2buc 2bum 2buo 2buy 2bvh 2bwi 2bxu
2bzo 2cc 2cdr 2ce 2erb 2cs 2ctn 2cty 2cuo 2cuq
2cuy 2cw 2cx 2cxl 2cys 2czr 2dg 2dh 2dm 2ef 2ev
2fa 2fm 2fo 2fs 2gc 2hc 2hh 2ie 2in 2jo 2lk 2md
2mf 2nm 2ns 2oe 2ol 2or 2ot 2ov 2pf 2pp 2ps 2pv
2rs 2sm 2sq 2tr 2ty 2ub 2uo 2us 2uz 2add 2aef
2afx 2ahl 2aib 2aim 2aid 2akv 2amx 2anh 2apx
2auv 2bms 2bph 2bqz 2bwt 2cbt 2cdv 2cf 2cfc 2ckj
2ckl 2cmg 2dg 2dh 2ep 2gp 2iu 2jo 2ke 2kr 2la
2ld 2ll 2lm 2ln 2m 2nr 2ob 2oc 2pd 2pe 2pf 2pg 2ph
2sh 2sj 2ss 2sz 2ta 2ut 2wm 2aar 2ac 2acz 2cu 2db
2dc 2ei 2ft 2fu 2ge 2gz 2hx 2iy 2ic 2iz 2kl 2ll
2mn 2nh 2ob 2oc 2od 2q 2qb 2z 2am 2rn 2rq 2si
2sl 2tk 2tr 2tu 2u 2uk 2vw 2xe 2ay 2ayl 2ql 2yb
2zal 2am 2vt 2adg 2adm 2agk 2ajt 2ake 2aly 2amn
2arg 2atv 2avg 2avu 2bok 2bou 2byn 2cdu 2cc
2ces 2ejm 2ckc 2cno 2epf 2eqj 2erp 2exd 2dij 2dkd 2dks
2dne 2dnh 2dno 2dxy 2sq 2kc 2li 2on 2pl 2wt 2xe
2ydg 2ydk 2ybw 2ybs 2yeg 2yim 2ykl 2ypp 2ypl
2yqz 2eyj 2en 2erd 2erj 2dbj 2ick 2ef 2ehn 2eld
2ellnc-lac ne-lad ne-lar ne-lbi ne-ldq ne-2be ne-2bg
ne-2bv ne-2fc ne-2gg ne-2ai ne-2bc ne-2co ne-2rg ni-2pz
nm-1j nm-1n un-1nic nq-4bj nq-2ac nq-7cx nr-2fg
nr-2gph nr-cto af-lb ag-rann al-2kt ai-2kw al-2kx
aq-ldh aq-lhf aq-ilm aq-lmdz fe-egex fi-1ta ai-lab fo-a3

THOUSANDS

WILL TELL YOU

Majestic

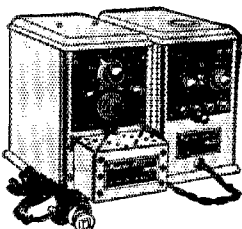

Dry "A" and "B"
UNITS

ELECTRIFY

ANY
RADIO SET

and give

BETTER RADIO RECEPTION

THAN ANY OTHER FORM OF
ELECTRICAL RADIO POWER

See your nearest dealer today—any good radio store. Try Majestics on your set and note the difference.

You plug Majestics in and forget them.

GRIGSBY-GRUNOW-HINDS CO.

4540 ARMITAGE AVE.

CHICAGO

Here is the New A. C. and D. C. Radio Set Tester



Model 537

A "UNIVERSAL" Aid to Radio Set Servicing

More Calls--Complete Set Owner Satisfaction--Bigger Profits.

Weston Electrical Instrument Corporation
602 Frelinghuysen Avenue Newark, N. J.

NOT merely an instrument—but a complete radio service man's equipment. With this outfit you can set yourself up in business—and a very profitable business, too. Dealers everywhere are looking for men experienced and equipped to service radio sets. With this outfit and the complete instruction book which is included with it you can be an expert with a little practice. It takes only a few minutes to make every test on a D. C. or A. C. set. Hundreds of men with only a few hours' self-training are making as many as twenty service calls a day, and making money on battery and tube sales besides. Let us show you how. Write for complete information.

WESTON RADIO INSTRUMENTS

BEN'S RADIO BARGAINS

MERSON 60 MFD COND. \$4.00; R. C. A. UV 712 audio transformer \$3.95; Faradon mercury condensers \$0.50; 2 MFD. fixed condensers 500 volt .95; Hoyt 2 in panel meters 0-6V; 0-3amp. \$1.45; Hoyt peep hole, all sizes. AC and DC V \$1.95; Wireless keys, heavy contacts practice key .69; Skinderviken trans. relay bottom .95; Milliammeters 200 mls. Hoyt \$3.75; Trans. Insulators 18 in. .45; 2 for .75; RCA 1856 fl. trans. 50 watt \$6.75; RCA 1658 fl. trans. 150 watt \$9.75; Plug in tip and jack for coils, etc. .15 pr.; Honey comb 3 coil mounts, gear type \$3.25; 5000 ohm pore. grid Leaks tapped \$1.75; Faradon ant. fixed .000025 cond. .45; Comp. AERO 3 tube short wave kit \$34.50; Comp. REL 3 tube short wave kit \$26.75; New improved Vibroplex Keys \$17.00; Cootie keys, new and better type \$5.50; High pitch adj. buzzers \$1.00; Wave-meter boxes, well made \$1.50; Small cabinet and panel 6" x 12" \$1.00 Radio Ben.

C.O.D. AND MAIL ORDERS FILLED—P. P. EXTRA
EVERYTHING FOR THE AMATEUR AT BEN'S

BEN'S 228 Tremont St., Boston, Mass.



GRIDLEAKS

| | |
|---|---------------|
| 15,000 ohm, tapped at 5,000 and 10,000 ohms with 85 watt capacity | Price, \$1.50 |
| 20,000 ohms, 85 watt for UX852 | 1.50 |
| 5,000 ohms, 85 watts | 1.00 |
| 5,000 ohms, 20 watt for one UX210 | .75 |

Postpaid

UTILITY RADIO CO.

80 LESLIE STREET EAST ORANGE, N. J.

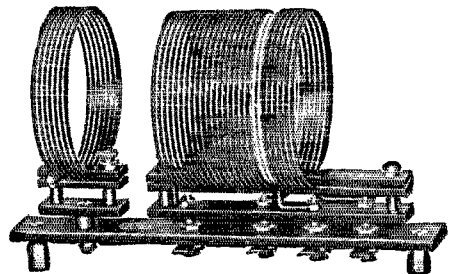

The NEW CHI-RAD Short Wave Coils

20—40—80 Meter Band

Designed by Chi-Rad engineers to meet the demands for an extremely efficient short wave coil. Complete with mounting, hardware and three interchangeable plug-in coils to cover 20, 40 and 80 meter wave bands. These coils are noteworthy for their convenience in design, neatness in appearance and sturdiness in construction. All plugs give positive contact.

| | |
|---|---------|
| Chi-Rad Short Wave Coils Compare for 20, 40 and 80 meter band | \$10.00 |
| Extra coil for broadcast band | \$ 4.00 |

Dealers and Set-builders—write for further details and discounts.

Chicago Radio Apparatus Co.

415 South Dearborn St. Chicago, Ill.

THE Great New VIBROPLEX

Reg. Trade Marks: Vibroplex-Bug-Lightning bug

No. 6

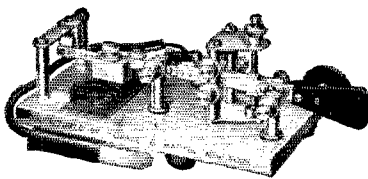

Japanned Base \$17
Nickel-Plated 19

More beautiful. More efficient. A great bug! Hundreds already sold.

Famous Improved Vibroplex

Used the world over because of its ease and perfection of sending. Over 100,000 users.

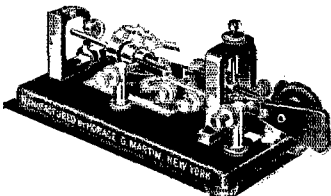

Special Radio Bug

Equipped with extra large, specially constructed contact points to break high current without use of relay

Japanned Base \$17
Nickel-Plated 19

\$25

Remit by Money Order or Registered Mail.

THE VIBROPLEX CO., Inc.

825 Broadway NEW YORK
Cable Address: "VIBROPLEX" New York

fo-g3v fo-a3z fo-a4x fo-a5x fo-a6n fo-a9a fq-pm
sa-bal sa-cb8 sa-dh2 sa-de3 sa-dr4 sa-dz9 sa-en8
sb-lad sb-laf sb-lah sb-laj sb-lak sb-lal sb-lam
sb-lao sb-lap sb-lar sb-law sb-lax sb-lbe sb-lbr
sb-lbw sb-lby sb-lca sb-lcg sb-lcj sb-lcl sb-lcm
sb-lic sb-lia sb-lar sb-lar sb-lar sb-lar sb-lar
sb-2al sb-2am sb-2ap sb-2ar sb-2as sb-2au sb-2ax
sb-2ay sb-2ia sb-2ib sb-2id sb-2ig sb-2ia sb-2ia sb-2ia
sb-svap sb-snf sc-lie su-lcd su-lux au-loa su-2ak
oa-2no oa-2rx oa-3wm oa-3xo oa-5ax oa-7cw op-lau
op-lhr op-3ac op-lat oz-lai oz-2go oz-3ag oz-3ai
oz-4ac oz-4ao oik rjc vidg wnp.

R. A. Rowden, 12 Pennsylvania Road, Exeter,
(England, Dec. 23, 1927 to Jan. 14, 1928)

(20-meters)

laem laff lajz lana larx lasf lask lavl laxa
lbeb lbed lbw lbwm lbyv lefo lekp lemf lfs lga
lic lkh lkj lkl lrw lsz lyy lxx lya lzn lzm lzo
2afw 2amf 2aut 2bad 2bal 2baz 2bhf 2bum 2amu 2evj
2eug 2gp 2jn 2md 2tp 2tu 2adm 2aib 2eei 2gw 2vg
4ob 4px 6ary 8abx 8adg 8afq 8ahc 8aly 8arb 8axz
8ayu 8bak 8cbi 8eel 8ecq 8ejm 8emb 8ddn 8dix
8did 8dne 8hx 8nt 8ou 8xe 9anu 9bqy 9erd 9dbj
ne-2al ne-2be ne-3mp ne-3ae ne-4pq fo-a3z oz-2xa
wnp.

(30 to 45 meters)

laaw lab labv labz lah lage lagi lajc lajz
lamu lanx lapq larv lasa lask lasu lavl lawm
laxq laxx lba lbcg lbed lbge lbjc lbke lbib lbif
lbis lbqd lbqs lbr lbfc lbu lbhw lbxc led lch leio
lejc lekp lelv lemf lemx lemy letp ldi lfo lho
lid lka llx lms lno loo low lro lrp lsi lwl 2abp
2abt 2acd 2adh 2adi 2arf 2ahm 2ain 2aip 2alu 2anz
2ann 2aog 2apd 2aqo 2arr 2atq 2ats 2avq 2awq
2bav 2baz 2beh 2bek 2bcu 2bev 2bew 2bdc 2bhd 2bdj
2bek 2ber 2bew 2bfj 2bhb 2bhf 2bhr 2bir 2bo 2box
2bse 2bvh 2cd 2ef 2em 2eu 2ev 2etp 2ena 2eb 2cvj
2ow 2ex 2ff 2fs 2gd 2gp 2hc 2ie 2ic 2jp 2mb 2mg
2og 2op 2ps 2qa 2sm 2sz 2tf 2uo 2wi 2ws 2acm 2ade
2aed 2afj 2af 2afw 2aib 2aih 2aim 2ajd 2amb 2anh
2ani 2apx 2as 2avk 2awf 2bom 2bnu 2bjd 2bse 2buv
2bwv 2ceb 2efg 2ekj 2dh 2ee 2ep 2ev 2fo 2fv 2gi 2gp
2hh 2iq 2ke 2kt 2nc 2nr 2pl 2pr 2qe 2qw 2ra 2sn
2sz 2vx 2wm 2aar 2acd 2acn 2adp 2acy 2acz 2adg
2ay 2bl 2bn 2cf 2cj 2db 2dl 2gg 2hx 2hz 2kw 2lk
2nh 2oc 2oh 2on 2oo 2pe 2pi 2qb 2rn 2rp 2rq 2rr
2si 2to 2tp 2xe 2yao 2ydo 2yge 2ayq 2ayx 2uae 2avs
2ke 2mx 2oc 2rd 2rg 2uv 2wz 2yb 2zg 2am 2ary
2sp 2afq 2ahm 2amy 2av 2aw 2axa 2axx 2bz 2bhx
2bjb 2bni 2box 2bo 2byv 2ccq 2cfl 2cfr 2cnn 2cvs
2cm 2cft 2civ 2dne 2dod 2don 2djp 2dsi 2ee 2gz
2il 2it 2sv 2zxe 2yab 2ybr 2ycl 2ydu 2adk 2aek 2ahz
2alo 2ala 2alk 2aok 2apy 2axf 2ayp 2azf 2bao 2bed
2bht 2bhm 2bpm 2bc 2bul 2buu 2bxj 2bza 2edi 2efn
2ecr 2eha 2eis 2epc 2er 2es 2fax 2gcd 2gde 2gdp
2gs 2dws 2dvi 2eaj 2ed 2eej 2eek 2ek 2ekw 2eb
2eld 2ell 2elm 2er 2eta 2ew 2gh 2hi 2ic 2kb 2ml
2nr 2oj 2pd 2pm 2qj 2rp 2rs 2sa 2wb 2za ne-lak
ne-lav ne-lbr ne-2ax ne-2be ne-3es ne-3ey ne-3rv ne-9bz
ne-8ae nd-bik nq-2cf nq-2kp nq-5ry nn-linc np-4an
ni-2sh ni-3ra ni-2bg ai-2kw ai-2kx ai-lhf as-lrra
fo-egex fi-lfw fi-lta fo-a3v fo-a8z fo-a4l fo-a6c fo-
a7d fo-9m sb-dc3 sb-lao sb-lap sb-law sb-lbg sb-
leg sb-lic sb-lcm sb-licr sb-licd sb-lig sb-2ax sb-2ay
oa-2dy oa-2tm oa-2vj oa-2dc oa-3af oa-3es oa-3kw
oa-3xo oa-5by oa-5wh oa-6wp oa-7ch oa-7ew op-lad
op-lbd op-lcw op-lgz op-lhr op-lmr oz-2ae oz-2bg
oz-2bp oz-3af oz-3ai oz-3ar oz-3au oz-3ar xoa-5ma
hval kfu pkh ril rjc tfa wmo.

ai-2KX, R. J. Drudge-Coates, Cambridge Barracks,
Rawalpindi, India

(Heard during January, 1928)

laqt laxa lekp lei lom lbuc lii 2awu 2lx 2ht
5mx 8alu 9erd 9epd 9bpm eg-2nm eg-2kf eg-2xy
eg-5aw eg-6yv egi-6mu.

ec-2YD, near Brno, Morava, Czechoslovakia.
(20-meters)

lcmf laj 2nm 2agn 2ahm 2tp 2aly af-1b ne-lar
ne-lad sb-lad sb-2fg se-2ah fm-8ip voq kzl 2xad
(40-meters)

lqb lxx lwj lsi lrv lbx lemp lajk lbed lajx
lekp 2ax 2pv 2tr 2md 2pp 2vo 2vs 2fs 2alu
2ary 2agn 2rb 2zf 2amx 2vb 2fu 2hd 4ob 5by 5atm
6bjh 6hz 8dz 8dz 8xco 9ael 9emj ag-rann as-lrra
fm-8ay fm-8jo fm-8rit fm-8sr fm-8chr fm-2ax fo-a9a
ne-8ae sb-lbg su-2ak oz-2ac oz-2me oz-3au pgo sad ael
wnp.

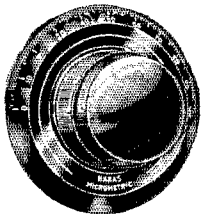

KARAS MICROMETRIC DIALS for Short-Wave RECEIVERS

2 Knobs—Rough Tuning and Vernier
Gold Inlay Markings—Look for Gold Band

Smooth, even tuning—free from backlash—is what you must have for successful operation of your short wave receiver! And that is just what you get from KARAS MICROMETRIC vernier dials! Easy to determine exact spot at which station comes in. Tune to 1/1000th of an inch; 63 to 1 vernier ratio; large knobs never tire hands. Instantly applied—no drilling, only one set screw!

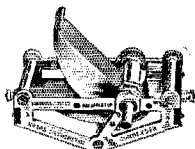

KARAS ORTHOMETRIC CONDENSERS

Ideal for short-wave receivers. Greater separation—broader tuning range.

.0001 .00014 .00025
List Price \$6.50 each

LIST PRICE \$3.50 EACH

Put Karas dials and condensers in your set today—and note the improvement! If your dealer cannot supply you, send your orders to us.

Send for Literature on 3-Tube Short Wave Kit

KARAS ELECTRIC COMPANY
4030D-N. Rockwell St., Chicago, Illinois

Unvarying Radio Insulation

impervious to dust—fumes—chemicals

FROM the day you install them, *PYREX Radio Insulators require neither inspection nor replacement.

Their constant electrical and physical characteristics are permanent.

They represent the true fusion of materials resulting in a homogeneous, nonporous insulator, uniform throughout its structure—high in dielectric strength—low in power loss. No "glaze" or coating to craze, check or decay. No pores to hold dust, soot or moisture.

And PYREX Radio Insulators are

indifferent to the corrosive action of water, smoke and acid fumes. Oil, grease and clinging dirt do not accumulate on their original diamond hard super-smooth surface.

PYREX Radio Insulators are specified in four branches of the United States Service, and in the country's largest broadcasting stations.

Write for "PYREX Industrial Glass Products"—a complete treatise on the special glasses from which PYREX Insulators are made.

CORNING GLASS WORKS

Industrial and Laboratory Division, Dept. Q-1

CORNING, NEW YORK

*Trade-mark Reg. U. S. Pat. Off.

BECOME A RADIO OPERATOR

See the World. Earn a Good Income
Duties Light and Fascinating.

LEARN IN THE SECOND PORT U.S.A.

Radio Inspector located here, New Orleans supplies operators for the various Gulf ports. Most logical location in the U.S.A. to come to for training.

Practically 100% of radio operators graduating on the Gulf during the past five years trained by MR. CLEMMONS, Supervisor of Instruction. Start training now for spring and summer runs.

Member of the A.R.R.L.—Call "5 G R"

Day and Night Classes—Enroll anytime—Write for circular.

GULF RADIO SCHOOL

844 Howard Ave. New Orleans, La.

Oscillating Crystals

Prices for Guaranteed SUPER-POWER CRYSTALS:

75.0-85.6 Meter, (3,500-4,000Kcs), band \$18.00

37.5-42.8 Meter, (7,000-8,000Kcs), band \$30.00

RESEARCH ENGINEERING COMPANY

915 Duff Avenue, Ames, Iowa

A Laboratory Product



**CRESCENT
LAVITE
RESISTANCES**

(For Distortionless Amplification)

Dual resistance for DeForest "H" tube \$8.50.
Consists of two units mounted on bakelite and connected in parallel. Please specify if your "H" tube requires 80,000 ohms or 20,000 ohms. All amateur apparatus in stock. Let us drill and engrave your panels.

Cresradio Corp., 166-32 Jamaica Ave., Jamaica, N. Y.



Trade Mark Reg'd Pat. Office

CONDENSERS

B-BLOCKS

VERITAS RESISTORS

Universally accepted as standard for the construction of Radio Receiving Sets, Resistance and Power Supply Amplifiers and Power Supply Units. Send 25c for new Power Supply Handbook.

Tobe Deutchmann Co.

Cambridge, Mass.

AMATEURS

The Most Interesting Field
for Experimenters.

Light Sensitive Cells

...AND...

Their Applications

PHOTO ELECTRIC CELLS

have been used in Television, Telephotography, Talking Movies and innumerable uses with:—

RADIO RELAYS

Our special polarized relay, a result of long research for a practical relay to be used with—Light Sensitive Cells—also used in connection with telegraph-printers, receiving time-signals and many applications in radio.

Write for further information:—

Photo Electric Devices, Inc.,
594 Fifth Avenue Brooklyn, N. Y.

A Simple Guide for Selecting Resistors

No matter how many claims are made for a resistor, you can always check up on its true worth by finding out who uses that particular make, and how it stands up under the rigid pressure of daily service.

We strongly recommend that you ask any one of the following companies about Harfield Resistors. They are but a few of a great number of concerns now purchasing Harfield Resistors in large quantities.

| | |
|--------------------------------------|----------------------------------|
| Stromberg-Carlson Telephone Mfg. Co. | Western Union Teleg'h Co. |
| Crosley Radio Corporation | Sonora Phonograph Co. |
| American Transformer Co. | Conner-Crouse Corp. |
| Fansteel Products Co. | Magnavox Corporation |
| Martin Copeland Co. | Electrical Research Laboratories |
| Splitdorf Electric Co. | Samson Electric Co. |

*[Tell us about the resistor you want
and let us make up a sample for you
with prices. Write to*

HARDWICK, FIELD, INC.

FACTORY
215 Emmet St.
Newark, N. J.



SALES DEPT.
100 Fifth Ave.
New York City

oa-4PN, Russell F. Roberts, Cambridge St., West End, Brisbane, Queensland, Australia

(Heard between Nov. 20, and Dec. 31, 1927)
1ab 1pp 1vc 2alu 3pr 5kg 5rg 5wz 5dhg 5agp 6am 6hm 6ap 6ave 6avj 6akw 6amm 6agg 6bvz 6bvv 6bpb 6egm 6enk 6dkx 6dch 6dqg 6dev 6dog 6dkt 6gn 6na 6uag 7hk 8tra 8hx 9wv 9wi oh-6dpg oh-6boe op-1ad op-1bd op-1hr oo-bam oo-geo ac-2ff ac-2cp ac-2ck ac-8na ac-8hb ac-8to ai-4dx ai-2kt ai-2kw ai-2gb eg-3kf ef-8fn ef-4bt ef-4bu ef-4no ef-4eo fo-a3z fo-a6p fo-a9a hlv wmo jav xoj zow xom agj arex pmz.

oa-5CM, Reg. M. Anthony, 3 High St., Unley Park, South Australia

1azd 1bux 1cmf 1emp 1de 1fl 1fs 1lx 2aed 2afr 2afv 2ahg 2aku 2alu 2azk 2bac 2bbi 2bfj 2ih 2hej 2bmz 2bph 2bqz 2bl 4lk 4si 4wn 5auz 5avs 5dm 5kc 5rd 5rg 5wz 5xm 6aak 6aej 6agz 6aix 6ajm 6akw 6alz 6and 6ary 6avj 6bel 6bef 6bfp 6bgb 6bjh 6bk 6bpc 6bpm 6brm 6brs 6cgy 6ch 6ck 6co 6wo 6ozm 6dag 6dan 6dki 6dkx 6dli 6dlm 6dmh 6dta 6ec 6emg 6fs 6go 6hj 6hm 6ju 6ty 6zd 7aae 7aax 7abh 7afo 7bzc 7ek 7lz 8amf 8axa 8axz 8bau 8baz 8bqm 8bwv 8ccw 8adq 8afe 8ajv 8ave 8bpm 8bpc 8bsz 8ckf 8ejn 8en 8ety 8cjr 8erd 8ard 8ef 8exe 8ff 8gy 8pu 8wb 8xl 8ws oh-6amu oh-6avl oh-6boe oh-6buc oh-6cqm oh-6dki oh-6dju oh-6dqg oh-6dqu oh-6dv od-pkl ac-2ck ac-hkg ac-8em ac-8hb ac-8na ac-8rj op-1hr op-1re aj-2bk ai-2kt ai-2kw ai-2kx ai-2bz ai-2jy fo-a3a fo-a3c fo-a3e fo-a3t fo-a3v fo-a3z fo-a4x fo-a5a fo-a6p fo-a6u fo-a7a fo-a7d fo-a7o fo-a8p fo-a8v fo-a8n fo-a9a fo-a9n fo-2sr fo-6ara fo-6sra fo-7sra fe-ogz xen-0cp ef-8eo ef-8fd ef-8jf ef-8fx ef-8yo ef-8zb eb-4bc ne-9ai smuk kfud.

KDOF-5PK, J. F. De Bardeleben, 723 Elizabeth St., Brownsville, Tex., on board SS Bessemer City.

(Heard between New Orleans, La. and Panama Canal)
1lbo 1mk 2sz 2uo 2pv 2erc 2afr 2me 2ag 3tn 3ac 3aj 3ebt 3bqz 3afw 3bjy 3gp 3aph 4tn 4ip 4wn 4fd 4cb 4ou 5gr 5yb 5aak 5pm 5ase 5aj 5rg 5ash 5ave 5axo 5ayb 6ty 6dfr 6ds 6awt 6zd 6cyr 6dkx 6dfr 7gr 7aat 7aln 8cwt 8ada 8bmq 8ccq 9efw 9dl 9ayp 9cx 9haz 9ff 9efe 9ep 9dy 9dme 9bz 9cee 9dku 9rp 9ejw 9erj na-1nic ndm nq-5ev ne-1ac nm-9a.

(Heard between Panama Canal and Hawaii)
2uo 2bfj 2aqf 2ash 5rg 7aln 7afv 7adb 7agb 7aba 9qy 9cph 9dak 9ctx oa-5ry nn-1nic nm-9a.

(Heard between Hawaii and Japan)
1xv 2uo 3rp 4si 4ow 4on 5aak 6cu 6chr 6dmm 6avl 6dv 6dlr 6dki 6dcu 6cag 6am 6aat 6nx 6we 6akw 6cfr 6iz 7cc 7acf 7uf 7wv 8ccw 9ox 9ahz 9axu 9aid 9cdw 9id 9cmz 9bqc 9dqu 9bht oa-1ew oa-2rf oa-4au oa-7cw oa-6am oa-2bf oa-4sk oa-3ai op-1dr op-3ac oo-dgk oo-ap4 aj-jex aj-jv xnu-6dhg fu9 fsm kf hza nvx ips sk-1 rep nigu ra-03.

KDVO, S.S. Samuel Q. Brown, in port at Amuay, Venezuela by Ben B. Skeete, (20-meters)

1atr 1ahy 1beb 1hv 1sz 1zz 2bbz 2bge 2ck 2gp 2vi 3akw 3jm 3aeb 4ec 4nl 5ar 5lp 5mk 6aat 6avj 6dev 6dc 6ear 6ary 6bf 6iny 6cxo 7vz 7fe 8dbe 8dzm 8cfr 8aub 8re 8dbj 8ajw 8wm 8dph 8ahm 9cuv 9cug 9dpw 9as 9eln 9anz ne-law nm-9a.

(40-meters)
1am 1lx 1beb 1aqp 1agw 2qu 2bew 2aed 2bda 2avg 2edm 2wv 2afs 2ecd 2hv 2gp 2aua 2bip 2ot 2an 2aby 2ach 2fg 2bay 2agw 2bcw 3ce 3sz 3ali 3anh 3ayk 3anf 3ua 3bui 4xz 4aar 4ky 4dq 4ox 4qz 4ed 4dt 4rp 4hr 4fg 5ia 5ac 5ab 5awg 5fb 5we 5mx 5avo 5ady 5ta 5apm 5aej 5vj 6brq 6hk 6chd 6hsn 6bpm 6ahp 6nw 6uf 6afs 6dog 6ec 6ahp 6adb 6iny 6czo 6bno 6eb 6bch 6am 6dwl 6bm 6biu 6bej 6hm 6au 6bjl 6ad 6dsu 7ff 8ebf 8axz 8aic 8dmz 8ec 8jb 8aig 8wo 8dfw 8si 8ahu 8hix 8cwr 9axx 9aok 9efz 9ewj 9ell 9dux 9bnh 9dke 9bqc 9hec 9bbw 9chs 9cuv 9dcb 9cm 9ayx 9bpn 9hi 9bad 9cwo 9cwa 9eft su-1fc nr-2ags sb-2ar ne-2be oh-6xk.

(80-meters)
1in 1bbj 1fl 1ait 1xv 1aef 1afb 1anh 1asd 2bic 2bfj 2dv 2cpg 2jx 2bcp 2aoo 2cp 2ab 2ast 2mt 2xg 2bse 2ec 2ev 2bex 2cyn 2exl 2alo 2bhl 2cbp 2epd 2dew 3uz 2jh 3xs 3asc 3aei 3cjr 3af 3zf 3ale 3zi 3adm 4cs 4lu 4fx 4bl 4ff 4sp 4en 5ua 5aqd 6aod 6don 8by 8dyk 8dte 8hvy 8buh 8jb 8mq 8cwr 8ano 8daq 8esw 8bnf 8don 8dds 9aaf 9cwo 9edo.

KOGR by 5SR-5PG Enroute San Juan, P. R. to Kingston, Jamaica

1arv 1bg 1ckp 1cm 1ewp 1nj 1an 1oz 1aba 1acm 2afv 2ags 2agw 2atq 2bps 2cvc 2exl 2dh 2fc 2jc 2md 2ns



\$4
Mesco Buzzer
set key and
buzzer, **1.95**

- No. 12 Enameled copper wire,
any length, ft.\$.01
No. 10 Enameled copper wire,
any length, ft.01½
Genuine Bakelite Panel
10x14½"1.50
Teco—50 Watt Socket1.45
Myers \$5 4½ volt Det. or
Amp tube, complete with
mounting clips95
Belden braid ¼ inch wide, ft. .06
Neon tube, type B, ultra
sensitive. Has sealed in
electrodes, positive contacts.
Best indicator for wave-
meter 1.50

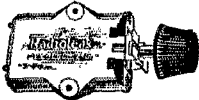

Bradley Leak, **2.95**
absolutely noise-
less and stepless,
2000 to 30,000 ohm re-
sistance. List \$5,
special \$2.95.

LEEDS

The Home of RADIO
45 VESEY STREET
NEW YORK

New York's Headquarters for
Transmitting Apparatus
When in Town Visit Our Store

Full Line of Acme -- Thordarson -- Jewell -- Flech-
theim -- General Radio -- Signal -- Bradley

SPECIALS

- Faradon U.C. 1803 Condenser cap. .000025-10,000 volts \$.95
Dubilier Mica Condenser .002 cap. 6,000 working volt 1.95
Dubilier 4 mfd. filter cond. tested at 1500V. D.C.
working voltage 500 1.75
General Radio 217D .001 cond. plain or with vernier 1.75
Dubilier cond. 1.7 mfd. 1,000V D.C. test; 650V. working
voltage 1.35
Dubilier cond. .5 mfd. 1,000V D.C. working voltage .85
R.C.A.—U.V. 1716 Super Het. transformer 1.45
DeForest audio transformer, built for 400 v. \$10 Het 3.45
Dubilier Duratron R. P. transformer 2.95
Ward Leonard Resistances; fits standard base receptacles;
sizes 300—600—900—1200 and 2000 ohms .95
\$15. Imported German head sets; very sensitive 3.45
Honeycomb Coils. unmounted, all sizes in stock at ½ price.
\$8 DeVeau adjustable arm micro-transmitter for panel
mounting 2.45
Heath condenser double spaced for transmitting .00025 cap 2.45
Dubilier buffer condenser .1 or .5 mfd. 400 v. D.C. each .50
Bristol 50 Henry choke 2.75
Western Electric modulation transformer 2.95
6.50 Acme .9005 enclosed condenser .95
Leeds 251 or 216B ½ wave rectifying tube 3.75
Leeds 213 full wave tube 2.95
Leeds 210 power tube 4.75

characteristics same as Cunningham tubes
MAIL ORDERS FILLED SAME DAY
10% Must Accompany All Orders

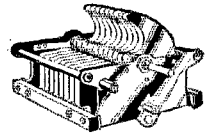

Cardwell con-
densers, double spaced for trans-
mitting, .00025 cap. **3.45**

- Electrad Wire Fixed Re-
sistance, type B, 25 watts, 2" long
5,000 ohm, centre tapped \$.95
10,000 ohm, centre tapped 1.10
Type C, 50 watts, 3" long
5,000 ohm, centre tapped 1.45
10,000 ohm, centre tapped 1.75
Type D, 75 watts
20,000 ohm, centre tapped 2.25



Flechtheim Condensers
all types 35% off list

RADIO OPERATORS WANTED

THE EASTERN RADIO INSTITUTE can train you
quickly and thoroughly because:

MODERN AND EFFICIENT METHODS
THOROUGH INSTRUCTION under staff of
LICENSED COMMERCIAL OPERATORS
MODERN APPARATUS including SHORT WAVE
TRANSMITTER

FIFTEEN years a RADIO SCHOOL
THE OLDEST, LARGEST and MOST SUCCESSFUL
school in New England. RECOMMENDED BY THE
A. R. R. L.

Day or Evening Classes Start Every Monday.

SPECIAL CODE CLASSES

Write for Illustrated Prospectus

EASTERN RADIO INSTITUTE

899 BOYLSTON STREET BOSTON, MASS.

QUARTZ CRYSTALS

Why not grind your own crystals? Guarant-
eed non-twinning. Cut to correct axis.
Sizes from 1.5mm. to 4mm. thick, ¼ in. to
1 in. square or round. Price \$6.00 each.
Prices of other sizes on application.

MASTER OPTICAL 'O., Inc., 19 W. 36th St., N. Y. City
Specialists in Quartz Optics

SIX PHASE

Mercury Arcs—Ready for you now. Give your
station that distinctive 360-cycle note that
makes 'em sit up and take notice. Output prac-
tically all D. C. Needs no filter. Great for that
DX phone. Single Phase Arcs unbeatable. No
words describe the six. Your rectifier problems
solved.

RECTIFIER ENGINEERING SERVICE
4837 Rockwood Road, RADIO 8ML, Cleveland, Ohio.

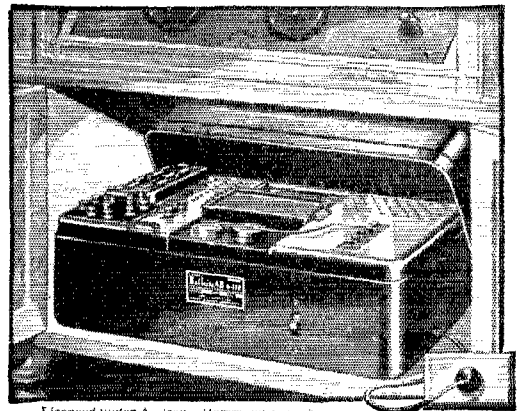

Licensed under Andrews-Hammann patent

The truest and clearest AC Electric
Radio is a standard set equipped with
Balkite Electric "AB" \$64.50 and
\$74.50. Ask your dealer.

Balkite

Radio Power Units

PRECISION!

Sangamo engineering of Audio Apparatus is followed up by precision production methods gained in nearly 30 years' precision instrument manufacturing. In Sangamo Transformers and Impedances the set builder and manufacturer is thus assured of that precise matching of each unit to the designated tube so necessary for superior tone quality.

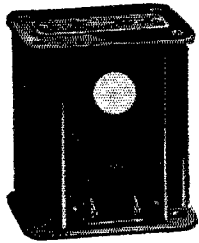

The "Yellow Spot"
Designates the Sangamo Type "A" Audio Transformer used for cascade amplification. This transformer has the flattest curve (most uniform amplification) available in any transformer at the present time. Look for the transformer with the yellow spot.

"Light Blue"
The Light Blue Spot identifies the Sangamo In-pull Transformer for push-out amplification. Has high inductance primary to secure high amplification on low frequencies. Accurately divided secondary gives almost identical frequency characteristic curve on each half. "Type B"—known by the light-blue spot.

"Dark Blue"
Output Transformer for push-pull amplifier having an impedance to match UX-210, (CX-310) and UX-112, (CX-112) tubes. Maximum transference of energy on low end of the musical scale.

Also makers of Sangamo Mica Condensers, moulded in Bakelite—made accurate and stay accurate.

"Green"
Same as above except impedance matches UX-171 and CX-371 tubes.

"Red"
The Red Spot designates the Sangamo Type "E" Output Impedance, keeps heavy D. C. "B" current from loudspeaker windings. Tap provided for matching impedance to UX-171 (CX-371) or UX-210 (CX-310) tubes, also UX-112 (CX-112).

"Orange"
Used for impedance coupled amplification, auto-transformer coupled amplification, or as impedance in plate circuit of detector tube to prevent feedback, oscillation or "motor-boating" in transformer coupled amplifier.

2xs 2zv 2ya 2za 3add 3adh 3afw 3anh 3au 3aua
3aqq 3bph 3gt 3hf 4aar 4abj 4abz 4ack 4acs 4acv
4adg 4anh 4ani 4bl 4bu 4cfv 4eat 4ft 4gg 4hx 4jr
4mi 4nh 4pj 4qy 4zr 4ta 4to 4ul 4wn 4vo 5ael 5adn
5adv 5afw 5an 5ann 5anw 5apo 5aq 5arf 5ase 5atn
5awu 5axq 5aye 5ek 5fh 5jk 5lv 5nc 5oc 5rj
5ry 5te 5uv 5wf 5yb 5az 5bz 6dl 6dy 6gp 6hm 6xi
7aa 7aw 7dk 7ek 7ii 8awo 8axx 8axz 8ayu 8bj
8bac 8brt 8byt 8cau 8ccs 8ccw 8cjj 8cdd 8dal 8dbc
8dcm 8ddz 8djj 8dmf 8dpo 8dsy 8ef 8fd 8gb 8it 8pl
8to 8agz 9aio 9ajr 9baz 9bbw 9bgq 9bhz 9bls 9bcb
9bqc 9buh 9cev 9cf 9cgg 9cia 9civ 9erd 9etz 9evd
9ezh 9dcl 9dfg 9drf 9efq 9ehr 9eih 9eio 9esm 9ewp
9fa 9lp 9pd 9ra 9uc 9yd.

KUJX, S.S. Liberty Bell, c/o R. J. Cotton, 1795
Lincoln Ave., St. Paul, Minn. Genoa, Italy.
(20-meters)

1aep 1bsu 1bxz 2ff 2bum 3hf 3apx 3cec fo-a3z
fo-af.

(40-meters)
1ac 1bw 1kh 1kw 1lc 1mv 1wl 1wy 1xz 1aao
1aex 1ale 1atj 1ayv 1bhs 1bqt 1com 2ol 2rs 2tp 2vd
2adl 2agv 2alu 2aqa 2ats 2bch 2bdc 2bir 2bl 2cty
2cqq 2enz 2ay 2ec 2ec 2nr 2oc 2wm 2abl 2aih
2ais 2akv 2awf 2bns 2cin 2id 2il 2oc 2oy 2rk 2si
2az 2ayl 2in 2yv 2air 2aua 2axx 2axz 2bni 2bpo 2brh
2ccw 2cpe 2dne 2don 2hi 2abu 2han 2dod aq-bd
eb-4cb eb-4cd eb-4cm eb-4dd eb-4di eb-4hp eb-4kb
eb-4vw eb-4ro eb-4rv eb-4td eb-4fd eb-4fr eb-4hj
eb-4lk eb-4md eb-4ng eb-ear23 eb-4bw eb-4ct eb-4fp
eb-4gi eb-4az eb-4flm eb-4mmp eb-4nxx eb-4orm
eb-4pns eb-4zf eb-4zh eb-4br eb-4qz eb-4jw eb-4sh
eb-4sk eb-4uw eb-4wv eb-4zy eb-4bz eb-4hp eb-4jv
eb-4vj eb-4vp eb-4wk eb-4lv eb-4ly eb-4fv eb-4fk eb-4ia
eb-4nd eb-4go eb-4rn eb-4cp eb-4vr eb-4fr eb-4g
eb-4gg eb-4qr eb-4oz eb-4ag eb-4ai eb-4bx eb-4am
eb-4b ne-1ad ne-1ar ne-2be ne-2cg ne-2ca eb-1ac
sb-1bg sb-1ib su-1oa.

Genoa, Italy to Gibraltar (via Leghorn and Naples)
(20-meters)

1rw 1sz 1wv 1xv 1afd 1aqt 1avl 1awe 1axa 2ch
2ff 2tp 2afz 2awq 2bbx 2bvi 2bkn 2hf 2zi 2aib
3cc 3cfz 4nh 8xe 8abx 8bto 8enz fo-a3z fo-af
deg.

(40-meters)
1ag 1bw 1fs 1gw 1hg 1id 1im 1kh 1lx 1mv 1om
1qb 1qv 1kc 1ro 1ry 1wl 1adm 1afl 1ajc 1ajx 1anx
1aqq 1ary 1ask 1asu 1bea 1bhs 1bhs 1bdq 1bqs
1bvf 1cpe 2az 2bz 2cy 2hc 2kx 2oc 2sm 2tp 2um 2uo
2vc 2vd 2ws 2zy 2adl 2alu 2aaj 2arm 2avq 2awu
2bav 2bdh 2bgr 2bit 2bis 2box 2buo 2caz 2cmu 2csz
2cua 2cwm 2dq 2ec 2gp 2jq 2abo 2acc 2add 2afx
2ahp 2aih 2anb 2anh 2ani 2apn 2avk 2ht 2id 2pf
2ais 2aps 2bkt 2chh 2cin 2bi 2bl 2cl 2cx 2cy 2ei
2fu 2hx 2ip 2kf 2kv 2ky 2lk 2lx 2mi 2px 2sv 2ta
2id 2ud 2ut 2vl 2wm 2yo 2abz 2fq 2jy 2ke 2kl
2oa 2rg 2we 2aak 2aao 2afe 2ahm 2ain 2api 2aqt
2aqv 2atf 2vzv 2asm 2avi 2bxi 2fh 2hc 2he 2jg
2pl 2qb 2rh 2wt 2zm 2ahu 2apd 2auc 2awu 2ayn
2bey 2bou 2brh 2bti 2bz 2cau 2cbr 2cft 2ck 2cl
2eno 2ens 2ero 2exd 2ezr 2dgc 2dhu 2dmf 2dmm 2dzc
2hn 2ez 2ic 2id 2im 2nn 2ni 2au 2adq 2ayv 2azq
2aqk 2ara 2ark 2arn 2avx 2baf 2bhz 2bir 2bkl 2bul
2cev 2ejw 2enc 2erd 2esa 2eva 2gdc 2gdx 2gex
2dkc 2dma 2dml 2dpy 2dqn 2dqu 2dra 2drj 2dwa
2ebm 2eck 2ek 2eme 2eqy 2eff 2ewp 2ezz 2az-1mdz
eb-4rs eb-4xo eb-4zy eb-4jk fo-a3z ne-2al ne-2bz
ne-1ar ne-2be ne-2cd ne-3ay ne-3bm ne-3cs oa-3vp
oz-1at oz-1fj oz-3au.

Calls heard between Gibraltar and Azores
(20-meters)

1br 1cd 1cx 1ez 1fl 1fs 1gw 1ia 1if 1jg 1mx 1nf
1qb 1ry 1sz 1xp 1xy 1zl 1aao 1aba 1aef 1aep 1aff
1ahx 1ajo 1ame 1aqt 1ask 1asr 1axa 1bdv 1bhm
1btq 1byv 1ckk 1cmp 1cpj 1cuq 2ek 2vi 2aef 2adw
2afx 2age 2agn 2alw 2amx 2aoo 2awf 2azk 2bac
2bad 2bal 2baz 2bge 2bha 2bac 2cxj 2ctq 2jm 2ke
2aib 2akw 2cec 2cgg 2bl 2px 2yo 2to 2we 2adg 2aek
2as 2gq 2rd 2gl 2oq 2rd 2re 2st 2xa 2se 2afq 2akn
2aly 2abc 2abz 2axx 2ayv 2bde 2bpd 2ben 2bki 2ebi
2eft 2ejm 2elp 2eog 2epf 2epx 2evj 2evq 2ezr
2dhp 2bjv 2dl 2dme 2don 2dsi 2as 2hm 2pu 2hx
2aid 2aiz 2bhb 2bmx 2bpm 2bqy 2che 2civ 2eb
2dbj 2dhp 2dng 2dpy 2ec 2ekw 2eoh eb-4a eb-4cb
eb-4rs eb-4xo eb-4zy eb-4jk fo-a3z ne-2al ne-2bz
ne-3bt ne-3qs ne-3bz nm-9a np-4sa o13, wup.

(40-meters)

1ac 1bw 1m 1ei 1fl 1gw 1id 1im 1ja 1ks 1lx
1mv 1oh 1om 1ql 1rf 1rp 1wl 1wy 1af 1ahx 1aj
1anz 1aqp 1arx 1ary 1ata 1atr 1aus 1awd 1bbe
1bbn 1bdq 1bea 1bhs 1bky 1bla 1bnm 1bdq 1bqs 1bwm

SANGAMO ELECTRIC CO. SPRINGFIELD, ILLINOIS.

BOUND VOLUME XI of QST

WE have now a limited number of copies of Bound Volume XI of QST. Vol. XI comprises the entire 1927 series of QST. This volume is made up of two books or sections, each containing six issues of QST. This volume is handsomely bound in red cloth and with gold imprint.

The complete volume is priced at \$5.00, postpaid. Better act quickly—only a few copies available.

QST

1711 Park St. Hartford, Ct.

WANT A GOOD GRID LEAK?

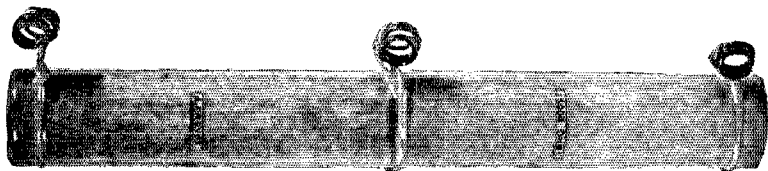

THE RESEARCH WORKER is a monthly publication of the

AEROVOX

Wireless Corporation devoted to the propagation of technical information. It may not be as useful as QST, for it isn't as big; but we know you'll get lots of good dope out of it. Send a QSL card or letter and we'll put you on the mailing list for the next issue. If you like it, tell us, also tell us what subjects you would like covered in future issues.

PYROHM

Vitreous enamelled resistors are really "Built Better". In Laboratory tests we have frequently overloaded them until they reached temperatures of 800°-900° without damaging them, although such usage is by no means recommended. If you want to end your resistor troubles, buy Pyrohms.

A FEW PRICES

| Type | Resistance | Watts | Price |
|------|------------|-------|-------|
| 998 | 30,000** | 200 | † |
| 998 | 5,000* | 200 | † |
| 996 | 30,000* | 100 | 2.20 |
| 996 | 10,000* | 100 | 1.70 |
| 894 | 50,000** | 40 | 2.05 |
| 894 | 10,000* | 40 | 1.85 |
| 992 | 15,000 | 20 | 1.00 |

Also many other sizes for plate, grid, and eliminator work. Send for list. If your dealer can't supply you, order direct.

†Prices on application.

*Center tapped. **Tapped in thirds.

AEROVOX

"Built Better"

70 Washington St., Brooklyn, N. Y.

FREE Wholesale Radio Catalog

Our new 1928 catalog is jammed full of the newest offerings of nationally known radio parts, kits, sets, accessories, table and console cabinets, etc. Whatever your radio need may be it's in our 1928 catalog. Also contains *Short Wave Section* showing the finest receiving and transmitting apparatus. Write for this big catalog—and for our confidential discount sheet—but write immediately.

SHURE RADIO CO., 349H West Madison St., Chicago, Ill.



RADIO THEORY AND OPERATING

3rd Edition, Revised—886 Pages—700 Illustrations—Price \$3.50

By Mary Texanna Loomis

President Loomis Radio College; Member Institute of Radio Engineers.

America's standard radio book. Used by Dept. of Commerce, U. S. Radio Schools, practically all Radio Schools throughout U. S. and Canada. Universities, Colleges and High Schools. Buy of your bookstore or order direct. Postage paid.

LOOMIS PUBLISHING CO.,
Dept. T-405 9th St., Washington, D. C.

Power Transformers

Guaranteed—Mounted—Complete

Can supply 2 and 3 phase transformers in addition to the following single phase.

| | |
|------------------------------------|---------|
| 1 KW, 2000-2500 v. each side | \$35.00 |
| 100 watt 250-330 each side | 10.00 |
| 200 " fl. trans. 8 or 11 v. | 7.50 |
| 600 " 1000-1500 v. each side | 14.00 |
| 600 " 2000-2500 v. each side | 21.00 |
| 200 " 550-750 v. each side | 10.50 |
| 200 " 25 cycle 550-750 each side | 14.00 |
| 700 " 25 cycle 1000-1500 each side | 22.00 |
| 700 " 25 cycle 2000-2500 each side | 28.00 |
| 30 Henry 150 mil. choke | 10.00 |

If fil. winding is desired on above plate transformers add \$2.00.

gCES F. GREBEN

1927 S. Peoria St., Pilsen Station, Chicago, Ill.

TRANSMITTING CONDENSERS

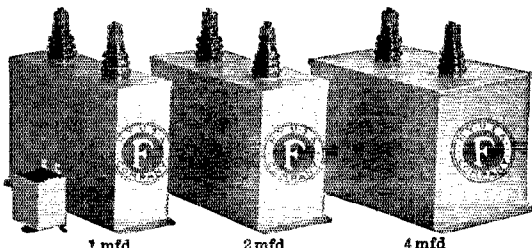

1 mfd

2 mfd

4 mfd

The finest amateur transmitting condensers made; ALSO, complete line of BY-PASS and FILTER CONDENSERS, for use in radio receivers and eliminators. WRITE FOR CATALOG.

FLECHTHEIM

SUPERIOR CONDENSERS

JUST OUT—NEW 2,500 VOLT DC CONTINUOUS OPERATING CONDENSERS.

Tested at 5,000 volts DC. Equipped with heavy porcelain insulators.

Now ready for immediate delivery.

A. M. FLECHTHEIM & CO., Inc., Dept. QT, 136 Liberty St., New York

MARTIN

MRS. J. L. MARTIN



THE NATIONAL CYCLE COMPANY
605 EAST 4TH STREET

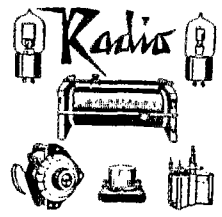

EVERYTHING FOR THE BICYCLE

AMARILLO TEXAS July 18 1927

192

Electric Specialty Co.,
225 South Street
Stamford, Conn.

Gentlemen:-

This will acknowledge receipt of yours 15th inst and we are pleased to say that the ESCO motor-generator sets used by us at WDAG, our broadcasting station, have given the best of service.

While we have never attempted to overload any of our apparatus we find that the ESCO machines working right at their limit have given excellent satisfaction and take pleasure in recommending them to anyone in need of such machines.

Trusting we will find it possible to assist you in placing machines in the future, we are

Yours truly

THE NATIONAL CYCLE COMPANY

By *J. L. Martin*
radio operator and engineer of WDAG

To Our Readers Who Are Not A. R. R. L. Members

Wouldn't you like to become a member of the American Radio Relay League? We need you in this big organization of radio amateurs, the only amateur association that does things. From your reading of QST you have gained a knowledge of the nature of the League and what it does, and you have read its purposes as set forth on page 6 of every issue. We would like to have you become a full-fledged member and add your strength to ours in the things we are undertaking for Amateur Radio, and incidentally you will have the membership edition of QST delivered at your door each month. A convenient application form is printed below—clip it out and mail it today.

.....1928

American Radio Relay League,
Hartford, Conn., U. S. A.

Being genuinely interested in Amateur Radio, I hereby apply for membership in the American Radio Relay League, and enclose \$2.50 (\$3 in foreign countries) in payment of one year's dues. This entitles me to receive QST for the same period. Please

begin my subscription with the issue. Mail my Certificate of Membership and send QST to the following name and address.

.....
.....

Station call, if any

Grade Operator's license, if any

Radio Clubs of which a member

Do you know a friend who is also interested in Amateur Radio, whose name you might give us so we may send him a sample copy of QST?.....

..... Thanks!

Ad. Auricma, Inc.
 Manufacturers' Export Managers
 118 Broad Street, New York, N.Y.

Scientifically equipped in economically export dependable receiving and transmitting radio apparatus.

5awq 5axn 5ayo 5ayt 5ce 5fo 5fq 5fb 5ge 5iz 5jc
 5jk 5oa 5ah 5ed 5ry 5tp 5uk 5ul 5uw 5we 5yb 5yw
 5zas 5acs 5ad 5afs 5ajj 5akm 5akw 5alr 5am 5and
 5asi 5atu 5auk 5av 5avb 5avz 5bch 5bdt 5bgh 5big
 5bil 5bjl 5bmo 5bpe 5brg 5bvz 5bwt 5bxi 5bxu
 5bya 5bzf 5bzs 5obe 5ocl 5edw 5eey 5ebt 5ctx 5ety
 5evj 5cut 5evu 5cyh 5cyr 5dex 5dey 5deu 5dfq 5dfs 5dfu
 5dhs 5dhu 5djw 5dix 5dkt 5dli 5dml 5dnh 5dog 5dps
 5dpo 5dsl 5dtm 5ec 5fs 5fz 5gm 5hm 5ho 5jz 5ky 5ge
 5wn 5acb 5afm 5ajh 5akw 5atv 5ca 5cx 5el 5fh 5gr
 5ip 5mo 5ok 5ne-lad 5ne-lap 5ne-lbi 5ne-lbr 5ne-lda
 5ne-3az 5ne-3el 5ne-3bc 5ne-3cc 5ne-3ni 5ne-3rp 5ne-4ac
 5ne-4ar 5ne-4ec 5ne-4cp 5ne-4jl 5ne-4hm 5ne-4hp 5ne-4et
 5ne-5cp 5ne-5er 5ne-5xt 5nm-lg 5nm-lr 5nm-23a 5nm-8a
 5nm-9a 5nn-1nc 5np-4aan 5nq-2eu 5nc-5ex 5nr-lfg 5nr-2ags
 5nr-2fg 5nr-1fmh 5nu-jj 5nx-1xl 5eb-4cb 5eb-4z 5eb-pl 5ef-8ba
 5ef-8cc 5ef-8ct 5ef-8fd 5ef-8fx 5eg-5ba 5eg-6rb 5ei-ldy
 5ep-laa 5ep-lag 5ep-lbk 5ep-lbl 5ep-3am 5es-ldy 5es-lfp
 5fo-3zv 5sb-lao 5sb-laq 5sb-law 5sb-lbg 5sb-lca 5sb-lcb
 5sb-lcm 5sb-lcd 5sb-lid 5sb-2ag 5sb-2ar 5sb-2ax 5sb-2jk
 5sg-3ac 5sc-laj 5sb-2as 5sb-3bd 5as-9c 5oa-2dy 5oa-3jk
 5oa-3wm 5oa-7cw 5oh-6avj 5oh-6dki 5or-3ar 5i-2kx 5am
 5zd 5bk 5ly 5ri 5ken 5vad 5wvw 5wvw 5wvf 5wgy 5om.

West Gulf Division Convention

THE HAMS in the West Gulf Division are widely scattered over a large territory, and holding a divisional convention isn't nearly so easy or simple as in some of the sections more densely populated with hams. However, for all that they lack in numbers they more than make up in enthusiasm and real old time ham spirit. This convention, sponsored by the University of Oklahoma chapter of Alpha Sigma Delta, national radio fraternity of hams at college, Norman, will go down in history as one of the livest and most successful get-togethers ever held anywhere.

Early on the morning of Friday, February 10th, the gang began to gather at the Post Office in Oklahoma City in anticipation of license exams. Many could be seen practicing up on circuit diagrams, wondering the meaning of QSC, or getting a last minute cram of questions and answers, but all for no good, for it seems that the R. I. got his dates mixed up or something, and failed to arrive. However, that didn't worry the gang long, for the next event was a big sight seeing trip in special busses. The point of greatest interest to most of the gang was perhaps the carrier current system, repeaters, etc., of the Southwestern Bell Telephone Co., who very kindly conducted us through the plant and explained how several conversations in each direction were carried on over a single pair of wires, which also served to operate an automatic printing telegraph for news and market bulletins. It seems that they have a fool-proof "anti-snaffling" system, for (as was unintentionally demonstrated when someone carefully removed a tube from its socket) the least disturbance of the works causes a loud gong to ring continuously until order is restored. Hi!

Other places visited included KFJF, the 1-Kw station with ten kilowatt modulation, 5QL, 5AFX, 5APG, 5ZAV, and the high-line carrier current phone system of the O. G. & E. Co., with which we were permitted to "work" similar stations over the state. The rest of the meetings were held in the Engineering Buildings of the University at Norman the gang all going to Norman in a body Friday afternoon, on a special interurban and in autos.

Norman in a body Friday afternoon, on a special interurban and in autos.

Where are your January, February and March copies of QST?

Certainly you need a binder for your 1928 copies as issued—

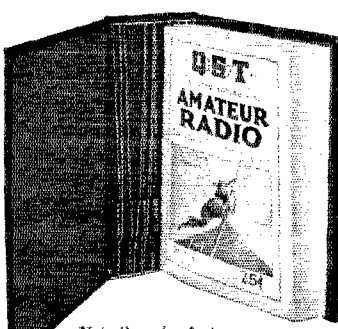

One-fifty each, post-paid

Note the wire fasteners. Unnecessary to mutilate copies. Opens and lies flat in any position.

A binder will keep your QSTs always together and protect them for future use. And it's a good-looking binder, too.

QST
 1711 Park St., Hartford, Conn.



Triple Range A.C. Voltmeter

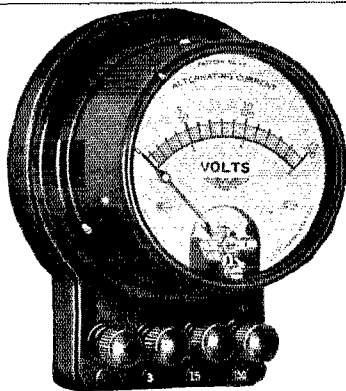

Pattern No. 77-

The Jewell triple range A. C. voltmeter, Pattern No. 77, presents the radio amateur and engineer with an instrument which will be found very convenient in checking and testing in connection with the new A. C. operated sets and accessories.

This instrument has a combination range of 0-3-15-150 volts. The scale is silver etched with black characters and the movement is mounted in a metal case on a bakelite base. Convenient means are provided for table or wall mounting, or the instrument may be used in portable work, for which it was especially designed.

Write for Special Circular No. 1145.

Jewell Electrical Instrument Co.

1650 Walnut St., Chicago

"28 YEARS MAKING GOOD INSTRUMENTS"

QST Oscillating Crystals

New Prices Effective April First, 1928

AMATEUR BANDS

Prices for grinding crystals at random frequencies which fall within the bands described below are as follows:

1715 Kcs. to 1825 Kcs. \$15.00.
1826 Kcs. to 2000 Kcs. \$13.00.
3500 Kcs. to 3650 Kcs. \$25.00.
3651 Kcs. to 4000 Kcs. \$22.00.
7000 Kcs. to 7500 Kcs. \$30.00.

The frequency of the crystal will be given accurate to better than a tenth of one per-cent. Immediate deliveries.

BROADCAST BAND

Prices for grinding crystals to your assigned frequency accurate to plus or minus 500 cycles are, \$45.00 unmounted, \$55.00 mounted. Three day shipment, and all crystals guaranteed. This crystal is our usual LOWER type. Crystals ground to any frequency between 40 and 10,000 Kcs. Let us quote prices for your particular requirement.

SCIENTIFIC RADIO SERVICE

"THE CRYSTAL SPECIALISTS"

P. O. Box 86 Dept. V Mount Rainier, Maryland

Become An Expert RADIO OPERATOR

Be the next World Champion! The Candler System of Training in High-Speed Telegraphing shows how. Theo. McElroy, World's Champion Radio Operator, endorses no other system. Read what he says—"At the Pageant of Progress, Chicago, I copied 56 words per minute for 5 minutes, establishing a new radio record, which I still hold. I owe my Skill, Speed and Steady Nerve both in sending and receiving to The Candler System." What this system has done for McElroy and thousands of others—it will do for YOU.

FREE Booklet explains system fully. Send for it TO-DAY. A post card will do. Send Now.
THE CANDLER SYSTEM CO., Dept. AR
6343 So. Kedzie Ave., CHICAGO, ILL.



Custom Set Builders

Building, as you do, a receiving set for the buyer who insists upon the best in radio, you naturally seek the very latest in design and finest construction in parts—at a price that permits a profit. Just as Dongan has always devoted its entire facilities to the manufacturers of sets, now Dongan recognizes the Custom Set Builder as a distinct factor in the radio industry.

Establish a Direct Source on Fine Parts

You can avail yourself of special discounts on audio transformers, B-Eliminator transformers, chokes and units, A C transformers and units, power amplifier transformers, etc.—all approved parts designed in one of the world's finest radio parts laboratories and manufactured in one of the most modern and well-equipped plants.

For converting D C sets to A C—or for building new sets—write for our Custom Builder's proposition. Your source is direct and satisfaction guaranteed. Find out about this at once. You can improve the quality of your work and receive added profit.

Transformer Headquarters for Set Manufacturers

In designing your new set, take advantage of the research work on power transformers developed in the Dongan laboratories. Every feature of approved design available.

Dongan Electric Manufacturing Co.

2999-3001 Franklin St., Detroit, Mich.

TRANSFORMERS of MERIT for FIFTEEN YEARS

How to be a commercial Radio Operator

A practical book that should enable anyone of average intelligence to pass the Government's theoretical examination given to applicants for a Commercial Radio Operator's License.

JUST OUT Nilson and Hornung's PRACTICAL RADIO TELEGRAPHY

380 pages, 5x8, 223 illustrations
\$3.00 net, postpaid

The book covers in detail the theory and practical operation of every type of modern, 1928, commercial arc, spark, and vacuum tube transmitter. It furnishes complete data on commercial vacuum tube receivers. It covers everything from elementary electricity to the practical operation of radio compasses.

Some outstanding points

1. Very little mathematics;
2. Assumes no prior knowledge of electricity;
3. Covers everything in commercial radio in detail;
4. Complete list of self-examination questions;
5. Simple, yet rigidly accurate;
6. Complete wiring diagrams given.

See the book before you purchase. Fill in and mail just this coupon.

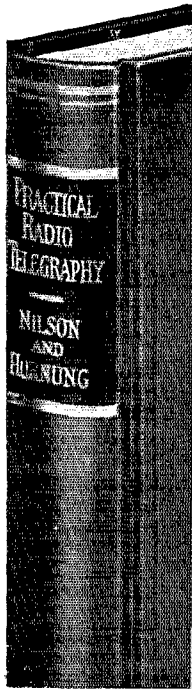

McGRAW-HILL FREE EXAMINATION COUPON

McGraw-Hill Book Co., Inc.,
370 Seventh Avenue,
New York, N. Y.

You may send me Nilson and Hornung's PRACTICAL RADIO TELEGRAPHY, \$3.00 net, postpaid. I will either return the book, postage prepaid, in 10 days, or remit for it at that time.

Name

St. & No.

City

State

Name of Employer

Official Position

(Books sent on approval in the U.S. and Canada only)

QST 4-1-28

By this time everyone was well acquainted, and the first formal meeting, Friday night, was presided over by division director Frank M. Corlett, and was primarily a traffic meeting. Louis Falconi, 5ZA, the first Hoover Cup winner, told us how traffic was handled in the old spark days. Lyman Edwards, 5FJ and R.M. of Okla., gave several humorous anecdotes of his first trip as a "lid" commercial operator on the Great Lakes. All the SCMs present then gave brief talks on the organization of the Communications Department, particularly in their sections.

Saturday morning was given over entirely to contests and stunts, of which the Oklahoma City "Oklahoman" says "the picnic part of the affair included contests to determine the fastest undresser, champion static spitter, biggest and worst liar, and champion permanent waver!" 5ZAV won the prize for best explanation of the action of a crystal detector, based on his extensive independent research and difficult mathematical derivations, and entirely unbiased by opinions of other famous scientists.

The main technical meeting Saturday afternoon included talks by Prof. F. C. Tappan and Prof. O. W. Walter of the Electrical Engineering department, Mr. Roy Allen who told of new R.C.A. tube developments; 5ZAV, 5APG, 5AKN, 5AJ, and 5ZA.

The banquet Saturday night opened and closed with rousing cheers for Alpha Sigma Delta, the organization that made this wonderful convention a reality. Prizes were awarded by 5AQQ to all contest winners, several hundred dollars worth of real ham apparatus having been contributed by QST advertisers. The grand prize, a UX 852 watter bought and contributed by Alpha Sigma Delta, was won by 5ANK of Dallas. Happy boy!

—Pat Shultz, 5AQQ-5AOC.

Strays

A letter headed "A Hot One" appeared in the correspondence columns of QST for April, 1927. This letter has been the cause of an undue amount of bitter feeling. Such is entirely out of place in any amateur game. Moreover, further consideration discloses the letter to have been too personal in its wording; also lacking in consideration for possible reception conditions at the stations concerned, which conditions might well have accounted for the contretemps as related. We regret the publication of the letter.



A CONE SPEAKER

Transformers

and
Choke
Coils

Of course Acme builds them. Acme products are nationally known.

Furnish us with your blue prints and specifications for prices.

We invite your inquiries.

Member R.M.A.

The Acme Electric & Mfg. Co.

Established in 1917

1653 Rockwell Ave., Cleveland, Ohio



HAM-ADS

NOTICE

The "Ham Ad" Department is conducted strictly as a service to the members of the American Radio Relay League, and advertisements will be accepted under the following conditions.

(1) "Ham Ad" advertising will be accepted only from members of the American Radio Relay League.

(2) The signature of the advertisement must be the name of the individual member or his officially assigned call.

(3) Only one advertisement from an individual can be accepted for any issue of QST, and the advertisement must not exceed 100 words.

(4) Advertising shall be of a nature of interest to radio amateurs or experimenters in their pursuit of the art.

(5) No display of any character will be accepted, nor can any typographical arrangement, such as all or part capital letters, be used which would tend to make one advertisement stand out from the others.

(6) The "Ham Ad" rate is 7c per word. Remittance for full amount must accompany copy.

(7) Closing date: the 25th of second month preceding publication date.

THE life blood of your set—plate power. Powerful permanent, infinitely superior to dry cells, lead-acid, Bs, B eliminators. Trouble-free, rugged, abuse proof, that's an Edison Steel-Alkaline Storage, B-battery. Upset electrically welded pure nickel connectors insure absolute quiet. Lithium-Potassium solution (that's no lie). Complete, knock-down kits, parts, chargers. Glass tubes, shock-proof jars, peppy elements, pure nickel, anything you need. No. 12 solid copper enameled permanently perfect aerial wire \$1.00, 100 ft. Silicon steel laminations for that transformer 15c lb. Details, full price list, Frank Murphy, Radio 8ML, 4837 Rockwood Rd., Cleveland, Ohio.

HAWLEY Edison element battery and parts standard for over five years. Look at our patent pending connector—no thin wire to drop off—contains 20 times more metal than regularly used. Heavy shock proof cells, fibre holders, etc. Everything for a rapid-fire "B" supply. Complete assembled 100 volt "B" \$10.00. Knock-down kits at still lower prices. Chargers that will charge in series up to 160 volts \$2.75 to \$4.00. Trickle B Charger for 90 to 150 volt "B" \$3.75. Special transmitter "B" batteries up to 6,000 milli-amp capacity, any voltage. Write for interesting literature, testimonials, etc. B. Hawley Smith, 360 Washington Ave., Danbury, Conn.

ORS-5JY Jones, Old timer. Quit during war. Found speed 5 per only. In three days could do 15, now 25 plus. Says Radio Shortcut best method seen for beginners and increasing speed. Advanced hams should try it. See display ad this magazine. C. K. Dodge, Mamaronock, N. Y.

KNOCKDOWN transformers with primaries only, 50 watt \$2.50, 100 watt \$3.00. Transformers 650-7½ volts \$5.50; 550-5 volts \$4.00 all midtapped adjustable core chokes 30 to 100 henry 160 M.A. \$5.00. All parts for Raytheon eliminator \$14.75. Chokes, 30H, 60 M.A. \$2.00, 30H, 100 M.A. \$2.50, 3H, 2000 M.A. \$3.25. Cores only \$2.00. Tobe 1000 volt 4 microfarad condensers \$2.75. Write for further information and complete lists of material. M. Leitch, Park Drive, W. Orange, N. J.

TWO UX216B Kenotrons each, \$4.50, two UV217 Kenotrons each \$9.00, two UV202 Radiotrons each \$2.50, one 75 watt 7½ volt filament transformer \$4.50, four UC490 1 mfd. filter condensers 1750 volt, each \$2.00, 1 R.C.A. 50 Henry 300 mills filter choke \$8.00, one Briggs 6 volt A battery charger (5 amp vibrating type) \$5.00, Edwin R. Carlson, Waterman, Ill.

OMNIGRAPHS, Teleplexes, transmitters, receivers, chokes, meters, transformers, 50 watters, S tubes, motor generators, portable loop receivers, Vibroplexes bought, sold and exchanged. L. J. Ryan, Hannibal, Mo. 9CNS.

EDISON element rechargeable "B" batteries deliver pure direct current of low internal resistance. Rechargeable

hundreds of times. 100 volt, 3000 milli-ampere battery complete in metal case, wired and assembled \$12.50. 140 volt, \$16.00. 100 volt 1500 milli-ampere complete kit \$8.00. 140 volt \$11.00. 180 volt \$14.00. Complete "B" charger \$2.00. Type "A" elements with welded connector 5c per pair. Type 3-G, 6c. Type 5-G, 9c, 3000 milli-ampere. Prices include separators. Potash-lithium for 5 lbs. Edison electrolyte 85c. Edison "A" batteries 6 volt, 112½ ampere, \$16.00. Shipped fully charged. J. Zied, 834 North Randolph St., Phila., Pa.

QSL cards—unstamped \$1.00 per hundred. Government cards \$1.85. Prompt service 9BEU, 9032 Windom Ave., St. John's Station, St. Louis, Missouri.

HARGAIN famous DeForest S transmitting tubes, excellent oscillators and modulators filament 10 volts plate 500, price \$4.00. New. Include postage. Roger Ayers, 52 Orient Way, Rutherford, N. J.

ESCO 110-220 volt, single phase motor; 1500 volt, 500 watt generator; on standard sub base, \$90. F.O.B. Pontiac, Illinois. Also other used apparatus at bargain. L. T. Bourland, 620 W. Hill Street, Champaign, Ill.

SHORT wave transmitter, receiver, inductances and chokes made to order. Guaranteed products, 9" x 14½" cards made with call letters, \$1.25. Write for particulars. Harry O. Barschdorf, 1AVU, 171 N. Sumner St., Adams, Mass.

FOR sale—entire transmitter using UV203A tube and sync in Hartley circuit. Nothing additional needed but an antenna to put on the air. DX worked—OA all dists., OZ, AJ, NR, NN, all states U.S.A. \$75. cash F.O.B. Write for particulars. G. A. Jump, 1122 McClelland St., Salt Lake City, Utah, Radio 6ATU.

SELL: Plate transformer, Cardwell, variable transmitting condensers, transmitting grid leaks, Mershons, S. tubes, Cardwell receiving condensers, factory built short wave receiver, home made short wave receiver 2 step, Jewell milliammeter, Jewell thermo couple radiation meter. Write for list. 2SM.

WANTED—equipment for 250 watt transmitter, generator or MG. tubes, condensers, etc. Kennedy Universal Wave Receiver, Omnigraph, Relays, Meters, Special Laboratory Instruments, etc. All must be in excellent condition and priced right. C. Hayes, 2979 E. 73 St., Cleveland, Ohio.

FOR sale—New 204, \$45, 204A, \$100. Both in original crates. GE Kenotron units. ET3620 complete will handle four 210s. Gives good d.c. note, \$30 81H.

FOR Sale: Broadcast microphone studio type \$50. Three stage speech amplifier impedance coupled General Radio parts panel mounted in cabinet with Oto 50 milliammeter on panel \$50. Whittlesey 75 ft steel mast three sections \$75. Thordarson 300 watt fil. trans. \$10. General Radio wavemeter type 174C-70 to 1500 meters \$35. R.C.A. radiofrequency choke \$2.00; Two Tube filter condensers 1000 v \$8.00. Omnigraph 15 dial \$20. J. C. Gill, 125 Gill Ave., Galion, Ohio.

TWO complete mercury arc rectifiers. Thirty dollars each 8CMO, 20 Brandon Pl., Williamsport, Pennsylvania.

BULLETIN 66-E Lists the Ensall Radio Laboratory receivers, transmitters, wavemeters, etc., Item No. 69 and 68-A type receivers are the most modern types for amateur reception. Four and eight tubes respectively. We also make all types of apparatus for any radio purpose, including inductances, power transformers, rectifier units, filter chokes, high voltage variable condensers, plate reactors, etc. We build to order any apparatus using your parts if desired. Kit and blue print service on any power amateur station. Write for copy of Bulletin 66-E. Thos. Ensall, 1208 Grandview Ave., Warren, Ohio, 8BDN.

PANEL meters, 0-300 M.A. \$1.25, 0-10 A.C. filament \$2.45, 0-500 d.c. voltmeters, \$5.25, adjustable circle cutters 65c, 750 v. d.c. generator 500 watts, directly coupled to 110v a.c. motor with Rheostat and filter, \$55.00, R.C.A. 300 milliamperer filter choke \$10.00, R.C.A. 50 watter, \$15.00. Ed. Keers, 9CJR, 2300 E. Washington St. Joliet, Ill.

SELL—synchronous rectifier, \$20. Howard George, Pike St., Dunkirk, N. Y.

QSL cards, \$1.00 per hundred and up. Stationery with envelopes, \$1.25, samples free. SAAF, Bloomingsdale, Michigan.

HAMS: Get our samples and prices on printed call cards made to order as you want them. 9APY Hinds, 19 S. Wells St., Chicago, Ill.

QSL cards, two color \$1.00 per 100. Government \$1.90. Samples. F. L. Young, 9CKA, Corwith, Iowa.

FOR sale—brand new 800 watt short wave transmitter, excellent parts used throughout. Includes four 852s, mercury arc and equipment. Cost \$550, will sell for \$300 or make an offer. Write for description. Edward Cullen, Jr., 1462 St. Lawrence Ave., Bronx, N.Y.C.

QSL cards, 90 cents per 100. Samples. Russel Karg, 2156 W. 51st St., Cleveland, Ohio.

ANNOUNCING our completely new line of meters for amateur uses. Our special, 0-15AC filament voltmeter, \$2.75, 0-10 and 0-6AC, \$2.30 each, milliammeters 0-10, 0-25, 0-50, 0-100, 0-300 or 0-400 full scale only \$1.85 each. DC voltmeters: 0-8, \$1.75, 0-100, \$1.55, 0-300, \$4.20, 0-500 \$4.75 each. 150 volt AC line meter, \$4.55. Antenna ammeter 0-2.5 amps. hot wire, \$4.00. Trio consisting of antenna ammeter, filament voltmeter, and plate milliammeter. State ranges of last two. Price per set, \$7.50. All meters flush mounting. Laboratory experimental Neon bulbs, small 50c, medium \$1.50, extra large with standard base, \$2.00. C.O.D. on request. E. P. Hufnagel, 879 South 18th St., Newark, N. J.

ARL sweater emblems should be worn by all League members. They are yellow and black 5"x8" diamond, felt letters and embroidered symbol. Only \$1.00. Money order or currency only accepted. Eric Robinson, 135 Jefferson Road, Webster Groves, Mo.

LICENSED amateurs only—prepared in U. S.—Acro low wave tuner, \$7.70, transmitting kit, \$7.55, Brielle 36 inch cone \$19.75 kit, \$12.62. Nathaniel Baldwin C headsets, \$5.80. SP122 shielded grid tubes, \$4.76. Power Clorostats, \$2.31. Sangamo .001 or .002 5000 volt condensers, \$1.31. Discounts on Cardwell, Formica, Samson, Jewell or Weston (transmitting meters, 25%) 35%. On Sangamo, Daven Karas, Tohe, Amso, Carter, Ferranti, Vaxley, Hammarlund, Silver Marshall, Bodine, CeCo, Raytheon, 40%, REL items, 25%. Weekly experimenters-builders data sheets, 20 weeks, \$1.00, 52 weeks, \$2.50. Over two pounds catalog, data circuits, etc., 25c. Fred Luther Kline, Established 1920, Kent, Ohio.

SELLING out. Complete fifty watt set and parts. Write for list. nu50N, Box 205, Montgomery, Ala.

FOR sale, Stahl sync rectifier, good condition, \$20 cash less. 9PQ, Valparaiso, Indiana.

CRYSTALS: guaranteed power oscillators; 80 meter band, calibrated 1/10%. Limited number at \$12.50 each. Satisfaction or money back. E. G. Watts, Jr., 1024 Southwest Ninth St., Miami, Fla.

HAMS: Genuine brand new and guaranteed RCA UV208 50 watt tubes, \$10.98. Stromberg-Carlson 3 1/2 mfd. working voltage 500V filter condensers \$1.35. Readrite panel meters 0-15V A.C. \$2.00, 0-100 or 0-400 milliamperes 90c. Postage extra. "Hamsheet" 3c. Kenneth Hanftan, Waterville, Ohio.

FADA power rheostats three ohms, carry 2 1/2 amps. Keep filament center tap balanced. 5c cents postpaid. 2CEL, Robert Kraus, 2318 Fish Ave., Bronx, N.Y.C.

POSTPAID. Readrite panel mounting Milliammeters, your choice 0-300 or 0-400 Mils, \$1.00. Readrite panel mounting 0-15 voltmeters, \$3.00. Dubilier 1 1/2 Mfd. 1000 volt working voltage Filter Condensers, \$1.95. General Radio Wavemeters, Type 358, \$19.25. Sangamo .002 Mfd. Bypass condensers, 5000 volt tested, \$1.75. General Electric 5000 ohm Heavy Duty Gridleaks, \$1.25. Other prices on request. G. F. Hall, 535 West Hottter St., Philadelphia, Pa.

QSL cards: 100 plain cards, 95c; 150, \$1.20; 150 Govt. cards, \$2.50; radiogram blanks, stationery, etc. H. M. Seiden, Cranestville, Penn.

SELL Westinghouse 3 unit 800V 200W MG 110V 60 cycle single phase drive \$45.00. Field rheostat, \$5.00. sCYM.

WANTED: Grebe CR18 with set of coils in good condition. Will buy or trade. Kenneth Alley, Carthage, Illinois.

BURNT out plate and filament supply transformers re-wound equal to new and returned C.O.D. for one-half the price of a new one. Burnt out Audio transformers re-wound and returned postpaid \$2.00. 25, 40, 60 and 500 cycle plate and filament supply transformers to your order, rated output guaranteed. Filter chokes of any size to order, best materials used in all work. If it is a transformer or choke which you cannot get elsewhere I can build it. Junk, bargain, and information seekers save stamps. Nat G. Scott, New Albany, Mississippi.

U. S. Navy five watters type 1162, plate voltage 550 to 750, filament 7.5 to 8.5. While they last \$1.30 each. Chokes guaranteed to pass 160 mils at 750 volts, wound with Dudlo wire, price only \$2.95 each. Western electric

500 volt condensers \$1.00 each. UX210 type tubes \$5.25. Do away with sloppy slop jars our 750 volts 110 mil rectifier tube \$5.00. RCA UX250 the new 25 watt tube \$12.00. Neon tubes with a standard base and a guaranteed working life of over 2000 hours \$1.50 each. 7x18 panels \$1.00. All merchandise unconditionally guaranteed. All shipments made promptly C.O.D. Joe Bush, 178 Berkshire Place, Irvinton, N. J.

HEADQUARTERS for hams:—Mueller 150-watt input tubes \$15.00. UV 202 5-watters \$3.15. Complete 5-watt transmitters—tube, transformer, rectifier, key, etc., for 20-40 meters, each \$85.00. 20-40 meter receiver and one set \$17.50. Aerovox 1000-volt tested 1 mfd. condensers \$1.75. Potter 2000-volt tested 1-mfd \$2.50; 2500-volt 1-mfd. \$3.25. "Ham-List" 4c. Robert Curtis, 1109 Eighth Avenue, Fort Worth, Texas.

CURTIS-Griffith 250-watt power-filament transformers 350-550 each side \$10.50. New Thordarson power-filament transformer 550 volts, two 7 1/2-volt filament \$20.00; Thordarson Power Transformers 550-750 each side \$16.00; 1000-1500 each side \$22.00. Aluminum square foot 85c. Lead square foot 55c. Potter 2-mfd. 1000-volt condensers \$2.75. ARL Handbooks \$1.00. Amateur Callbooks \$1.00. New "Ham-List" 4c. James Radio Curtis, 5AQC, 1109 Eighth Avenue, Fort Worth, Texas.

TWO 88A input one 222A filter Western Electric superhet transformers, for \$17.50. Few new W. E. fifty watters \$24.00 each. Ham apparatus at discounts. 2BYJ, Levy, 2050—69th St., Brooklyn, N. Y.

GENERATORS, new 275 volt d.c. 120 watt gives up to 500 volts, \$8. Used 6 volt input dynamometers output 400 volts, \$15. Used 500 cycle generators 200 watt, \$10. 900 cycle dynamometers \$115.00. 1 Kw. and 1/2 Kw. new 120 volt d.c. drive, 500 cycle output motor generators, microphones, \$1. R. Wood, 46-20 102nd Street, Corona, N. Y.

NATIONAL Radio Institute course with code work—for cash or good transmitter. Describe fully your offering. 8BJO, Dundee, N. Y.

SELL three unit three tube Atwater Kent radio set mounted on baseboard and wires. Best offer takes it. 9AEH.

QST, The New RCA UX250 15 watt tube is here. Immediate delivery for \$10.75. Extra heavy 99.6% pure aluminum Company of America aluminum 70c sq. ft. We have any ham stuff made. Some items are recto-bulbs, super-synes, Vibroplexes, Cardwell condensers, mercury arcs, Flechtheim filter condensers (35% off), UX222 \$5.75, Westman RF amp. assembled \$13.75. Write for anything not listed and our money savings prices. 9ARA, Butler, Mo.

BREAKDOWN at 6000 volts means new condenser free .002 Fixed transmitting condensers: made of copper plates; glass dielectric, rugged aluminum finish case \$1.75 postpaid. R.C.A. 852's \$30. 2BGM-6724 Ridge Boulevard, Brooklyn, N. Y.

SELL—7 1/2 watt transmitter, bargains. If you're not interested in quality do not write. H. P. Brewer, Oskaloosa, Iowa.

HANDY'S Handbook specifies these condensers for that Precision Wavemeter.—Brand new General Radio Type 334-M. 250 mmf. list \$4.75. Price \$3.00.—Laboratory Precision Type 239-G. List \$13.50. Price \$7.50! Also new Acme 500 watt Plate Transformer \$20.00. See new ORAS, 9EYT.

WRITE for list of radio parts. 4ABR, Greeneville, Tenn.

OUR specialty is 852 transmitters and short wave receivers. Sell new Vibroplex. Write for details. 1034 Woodland, Ft. Worth, Texas.

TRANSFORMER RECLAIMING SERVICE. Stop throwing away valuable burnt out transformers. We replace with original factory windings—every job carries previous guarantee of transformer. Most leading makes reclaimed—\$1.25 to \$1.50. Correct engineering. A new one couldn't be superior. Also sell reclaimed transformers. Write your needs. H. A. Sears, 9 S. Reed Ave., Mobile, Ala.

NAVY standard compass receivers type SE1440A 150-1250 meters, equipped with detector 3 stages audio, ideal for commercial work and broadcasting stations, \$250. Western Electric tubes all sizes. Long wave navy receivers CN240 \$80. Navy precision wave meter \$87. Navy direct reading wave meters equipped with galvanometer manufactured by General Radio range 300-1000 meters. Can be calibrated for short wave use special \$13.50. Navy 300 watt General Electric battleship tube transmitters ideal for yachts and steamships. Navy spark transmitters from 1/4 to 5 kw. Write for prices. Other 500 cycle equipment. HAM SUPPLIES. Send

five cents for catalogue AND SAVE MONEY. Arthur Faske, 350 Stone Ave., Brooklyn, N. Y.

SELL—7½ watt transmitter, metered, REL inductances in fine cabinet. Bargain \$35. 9CTW.

LOOKING for bargains? We have a wonderful list of them—not the sort of odds and ends usually offered but new goods of real value. Send for it and get your share at half price or less. For instance—many standard variable condensers up to \$4.50 list, choice at \$1.95; \$10.00 247W General Radio Wavemeters, a few at only \$5.00; a Grebe CR18 at \$60.00. E. F. Johnson, 9ALD, Waseca, Minn.

2500 Volt 150 Watt generator connected to 110 Volt motor \$145.00. 2000 Volt 1000 Watt generator connected to 8 phase 220 Volt motor with separate field exciter \$275.00. 1000 Volt 200 Watt generator connected to 110 Volt motor \$75.00. 750 Volt 300 Watt generator with 110 Volt motor \$65.00. 10 Volt 8 Ampere generator \$12.00. ¼ Horsepower 110 Volt motors 1750 speed \$6.50, 3550 speed \$8.50. 1000 Volt generator with 10 Volt filament supply connected to 32 Volt motor \$150.00. Broadcast motor generators and filament generators also many others. James Smat, 1734 Grand Ave., Chicago, Illinois.

KNOW your wavelength—with Precisely calibrated Wavemeters, 17-160 meters—\$5.00. Foreign transmitting tubes: 50 watts—\$9.00, 10 watts—\$4.90, seven watts—\$4.00, 3000V, .002 condensers—\$1.75. RCA Modulation transformers \$3.50. Fada Power rheostats, 4 ampere—45c. RCA UX852's—\$32.00. Fleron 10" insulators—65c. Electrore standoff insulators—20c. REL transmitting inductances—\$3.50. REL receiving coil sets—\$8.00. Accurate milliammeters, 0-10—\$3.00, 0-100, 300, 400—\$2.00. AC Voltmeters 0-10, 0-15, \$2.00. GR Wavemeters—\$18.50. Rectifier elements, aluminum lead, pairs, 1"x4"—7c, 1"x6"—10c. QSL Cards, two colors, \$1.00 per 100. Free radio catalogue and QSL samples. William Green, 207 Cathedral Parkway, N. Y. C.

SELL or trade 100W-500V Peerless generator, \$20. 23 5c-350V Westinghouse dynamotor \$12.50 coils condensers, etc., cheap. J. P. Hyde, Bristol, Va.

ESCO MG 1000 volts 200 watts. Good shape \$85. 204 tube, slightly used, \$40. Modified COMO super, 6 tube, uses 201As, slight changes in inductances makes beautiful ham DX set \$35. SAOL, F. H. Garrahan, 390½ Northampton St., Kingston, Penn.

WANTED—Grebe CR7 long wave receiver range to 30,000 meters, also Grebe RORK two stage amplifier. State lowest cash price or will trade new Grebe CR9 or new broadcast apparatus. Miles A. Newton, Toulon, Illinois.

QSL cards, two colors, government postcards, \$1.90 per hundred, white cards \$1.00. Real ham stationery at \$1.40 per hundred sheets and envelopes, pad form. Postage 10c. Free samples. SDTY, 257 Parker Ave., Buffalo, N. Y.

NAVY standard transmitters and parts. Half kilowatt motorgenerators forty dollars. Two kilowatt hundred dollars. Dubilier .004 condensers eighteen dollars. SE1012 receivers thirty dollars. What do you want? Wanted—Navy receivers, SE143, SE1220, SE1420. State price, condition and manufacturer. Paul Trautwein, 15 Albany Street, New York City.

TRADE or sell eighty meter crystal. Herb Hollister, 930 Baltimore, Kansas City Mo.

PURE aluminum and lead rectifier elements holes drilled brass screws and nuts, pair 1"x4" 13c, 1"x6" 15c, 1¼"x6" 17c, 1½"x6" 19c. Sheet aluminum 1/16" \$1.00, lead \$1.00 square foot prepaid, \$1.00 or more. Silicon transformer steel cut to order .014" 10 lb, 25c, 5 lb, 30c, less than 5 lbs, 35c lb. .022" 5c less per lb. Not cut 2-7" wide 15c lb., minimum 10 lb. postage extra. Edgewise wound copper ribbon 7 sizes see January QST. Air pocket and stand off insulators 25c each. 4 for \$1.00. Glazed porcelain 5 and 6¼" long period on 4. Electrolytic condenser parts, \$1.50 prepaid. Geo. Schultz, Calumet, Michigan.

HELLO HAMS—Here is Ben with some real Ben's buys. Hoyt panel peep hole 0-5; 0-3; 0-3; volt 0-8 amp; these work on AC and DC and they are wonderful values at \$1.50. Also a few Hoyt 2" panel 0-8 volt at \$1.00 with push button. Neon bulbs and sockets \$1.75. R.C.A. OTs at a special \$7.75. Skinderviken transmitter buttons at 95c small but of a thousand uses. Lightning aerial switches, SPDT, 50c. Ward Leonard transmitting tapped 5000 ohm grid leaks 50 watt size \$2.75, 20 watt \$1.95. Telegraph keys Navy type 75c, special now. Cootie keys. They are here now at Ben's, \$6.75 and worth it. Antenna rings 50c. 600 volt 2mfd, \$1.00, 600 volt ¼ mfd 50c. Thousands of bargains always at Ben's, so don't hesitate to write even if for a small order, as Ben is always glad to hear from all his friends. Ben Wolf, 228 Tremont St., Boston, Mass.

SCUX, Millington, Mich. prints QSL cards the way you want them. 300 plain, two colors, \$3.15 postpaid. Write for other prices and samples.

JEFFRIES plate transformers, 1000 watts, 550-825-1100-1500-2200 each side, \$24.50. 1000 watts 2500-3000 each side \$27.00. Folder on request. 125 watt filament transformer 9-12 volts \$6.25. Carl Schwenden, 7427 Alameda Blvd., Los Angeles, Calif.

LOUDSPEAKER units rewound and magnets recharged \$3.00. 24 hrs. service. Henry Wagner, East Chicago, Indiana.

FOR SALE—7½ transmitter forty meter band. Complete, S tubes for rectifier. Mounted on panels with meters ready to operate. First 50 bucks takes her. D. E. Haist, Seaton, Ill.

Q R A SECTION

50c straight with copy in following address form only:

ICSX—R. O. Mortenson, 171 Cherry St., Malden, Mass.
1WV—Miles W. Weeks, 40 Norfolk Road, Chestnut Hill, Brookline, Mass.

2BUO—Werner H. Olpe, 14 Brooklyn Ave., Jamaica, Long Island, N. Y.

3AGE—B. J. Chromy, 1602 Hobart St., N. W., Washington, D. C.

3ARD—J. A. D. Boone, 3710 Parker Ave., Norfolk, Va.

6MU—San Francisco Radio Club, 454 Bright St., San Francisco, Calif.

8BWB—George K. Bernhard, 1067 Parsons Ave., Columbus, Ohio.

8DBF—John Hajduk, Jr., 13 Shingiss St., McKees Rocks, Penn.

9EYT—Raymond F. Knochel, 1427 Wisconsin Ave., Milwaukee, Wisc.

na7TO—H. H. Howell, Box 1411, Ketchikan, Alaska.

oa4PN—Russell F. Roberts, Cambridge Street, West End, Brisbane, Queensland, Australia.

sb2IA—Ruben Simas, Rua Riachuelo 91, Curitiba, Brazil.

The following stations belong to members of the A.R.R.L. Headquarters gang. Mail for them should be addressed care A.R.R.L., Hartford, Conn. When operating 1MK they use personal sines as indicated.

1MK Headquarters, Chief 1BIZ C. C. Rodimon "rod"
Operator, R. B. Parmeter 1BUD A. L. Budlong "bud"
"rp" 1ES A. A. Hebert "ah"

1AL H. P. Westman "ws" 1GO L. A. Jones "jj"

1BAO R. S. Kruse "lq" 1KP F. C. Beekley "beek"

1BDI F. E. Handy "fh" 1OA R. S. Kruse "ld"

1BHW K. B. Warner "kb" 1SZ C. C. Rodimon "rod"

PACENT DUO-LATERAL COILS

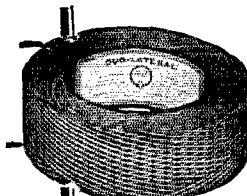

TODAY — as
eight years ago—

PACENT coils are the popular choice of experimenters, engineers and laboratories.

A complete line always on hand together with mountings.

Write for data and prices.

PACENT ELECTRIC CO., INC.
91 Seventh Ave., New York

Hey,
I am—
Have u ordered ur copy of
**Andy's
Handy
Handbook?**

THE BEST \$1 YOU EVER SPENT!

PUBLISHED BY
AMERICAN RADIO RELAY LEAGUE
17th PARK ST., HARTFORD, CONN.

Announcing the TABLE TYPE CLAROSTAT

EVERY man knows what to do with micro-
electric resistance—the kind that is pre-
cisely fitted to circuit requirements, and then
clearly built.

And now you can have microelectric resis-
tance as a convenient accessory. No need
changing the old set apart. No need for tools.
No need spending time and effort. Just con-
nect TABLE TYPE CLAROSTAT in circuit
by means of handy connection coils and block
and you have microelectric resistance on the
job.

Just the thing for experimental setups and
laboratory work. So handy! You can insert
three microelectric resistances anywhere in your
CLAROSTAT in your transmitting or receiving
circuit. The TABLE TYPE CLAROSTAT in circuit
handy in any place of apparatus. Finished in a
laboratory finish. Felt bottom. Two connection
coils and the connection block for insertion
in any circuit, other device. Resistance range
from practically zero to 500,000 ohms.
Phenylproton. Durable. In brief, a genuine
Clarostat in a new dress.

American Mechanical Laboratories, Inc.
Specialists in Variable Resistors
285-7 North 6th St., Brooklyn, N. Y.

Ask your radio dealer to show
you the Table Type Clarostat, as
well as Volume Control, Stand-
ard and Power types. And
don't hesitate to write us
for literature and for
whatever dope we can
give you.

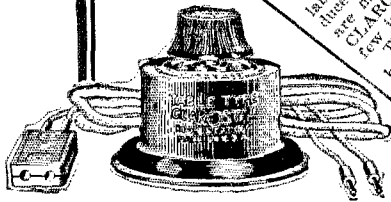

FOR YOUR CONVENIENCE QST'S INDEX OF ADVER- TISERS IN THIS ISSUE

| | |
|------------------------------------|---------------|
| Aeme Electric & Mfg. Co. | 90, 93 |
| Aeme Wire Company | 2 |
| Aero Products, Inc. | 81, 8rd cover |
| Aerovox Wireless Corp. | 85 |
| American Mechanical Labs. | 94 |
| American Sales Company | 95 |
| American Transformer Co. | 72 |
| Amrad Corporation | 96 |
| A.R.R.L. Application Blank | 87 |
| A.R.R.L. Binder | 88 |
| A.R.R.L. Bound Volume | 84 |
| A.R.R.L. Handbook | 72 |
| Auricma, Inc., Ad. | 88 |
| Barawik Company | 75 |
| BCL Radio Service Co. | 62 |
| Best's | 76 |
| Burgess Battery Company | 8th cover |
| Candler System Co. | 89 |
| Cardwell Mfg. Corp., Allen D. | 1 |
| Central Radio Labs. | 76 |
| Chicago Radio Apparatus Co. | 79 |
| Corning Glass Work | 81 |
| Cresradio Corporation | 81 |
| Crosley Radio Corp. | 77 |
| Cunningham, Inc., E. T. | 64 |
| Deuschmann Company, Tobe | 81 |
| Dodge, C. R. | 74 |
| Dongan Elec. Mfg. Co. | 89 |
| Dudlo Mfg. Corporation | 67 |
| Eastern Radio Institute | 83 |
| Electric Specialty Co. | 87 |
| Faomill Radio Company, Inc. | 76 |
| Fansteel Products Company | 83 |
| Flechteim Company, A. M. | 85 |
| General Radio Company | 2nd cover |
| Glenwood Labs. | 77 |
| Grebe & Company, A. H. | 4 |
| Greben, P. | 85 |
| Grigsby-Grunow-Hinds Co. | 78 |
| Gulf Radio School | 81 |

| | |
|---|--------|
| Hardwick, Field, Inc. | 82 |
| Jewell Electrical Instrument Co. | 89 |
| Karas Electric Company | 80 |
| Leach Relay Company | 75 |
| Leeds Radio Company | 83 |
| Loomis Publishing Co. | 83 |
| Mass. Radio & Telegraph School | 86 |
| Master Optical Company | 83 |
| McGraw-Hill Book Co. | 74, 90 |
| National Company, Inc. | 78 |
| National Radio Tube Company | 66 |
| Paent Electric Company | 93 |
| Photo Electric Devices, Inc. | 82 |
| Pilot Electric Mfg. Company, Inc. | 68 |
| Precision Crystal Service | 88 |
| Radio 2MA Company | 86 |
| Radio Engineering Labs. | 85 |
| Radio Institute of America | 79 |
| Rectifier Engineering Service | 89 |
| Research Engineering Co. | 81 |
| Saugamo Electric Company | 84 |
| Scientific Radio Service | 89 |
| See Jay Battery Company | 75 |
| Shure Radio Company | 85 |
| Stromberg-Carlson Telephone Mfg. Co. | 74 |
| Teleplex Company | 77 |
| Thurstonson Electric Mfg. Company | 69 |
| Utility Radio Company | 79 |
| Yibroplex Company | 80 |
| Ward Leonard Electric Co. | 77 |
| Well's Curiosity Shop | 86 |
| Weston Electric Instrument Corp. | 79 |
| Wireless Specialty Apparatus Co. | 63 |
| Taxley Mfg. Company | 76 |

Transmitting Apparatus

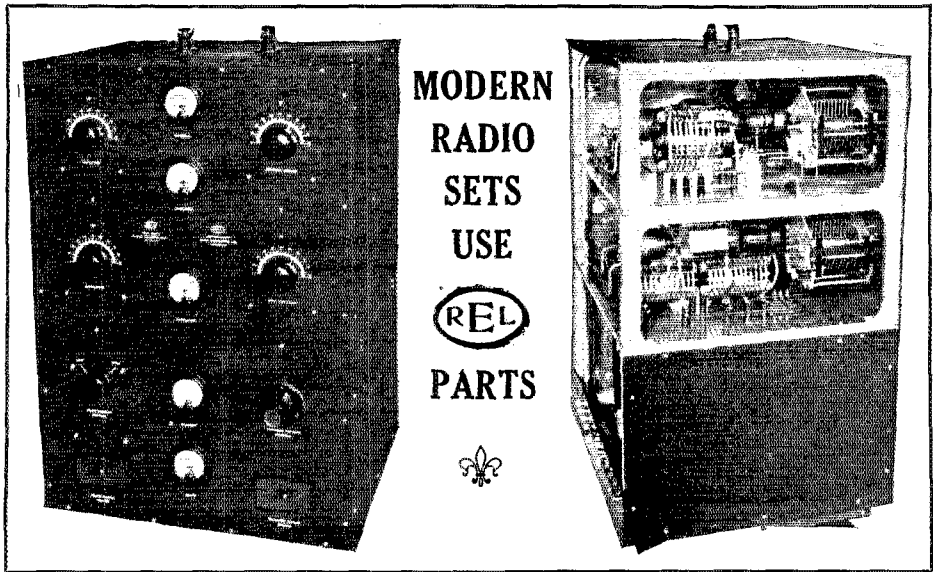

MODERN
RADIO
SETS
USE
REL
PARTS



250 Watt Master Oscillator Power Amplifier Short Wave Telegraph Transmitter employs REL parts throughout. Heavy aluminum frame construction with total shielding between amplifier, oscillator and power control circuit.

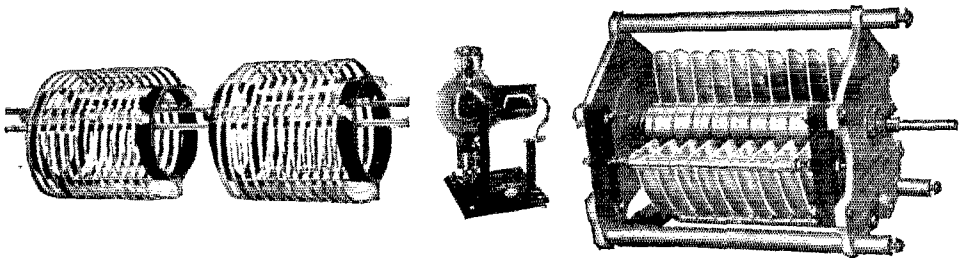

Wherever you see super transmission you'll find REL Quality Parts. Heavy duty Transmitting Condensers, the famous Inductances, flatwound on glass, Tube Holders, such as the UX852 Holder pictured above, that assure absolute rigidity and perfect contact. A complete line of REL Transmitting Kits adaptable to all popular types of tubes is available at moderate prices. Bulletin "T" describes the Kits. REL is steadily producing new developments of importance to all in the Short Wave field.

REL owns and operates experimental Station NU2XV on 15.1, 30.2, and 60.4 meters

Radio Engineering Laboratories

REL 100 Wilbur Avenue, Long Island City, N. Y. **REL**

Let us Send You This Book!

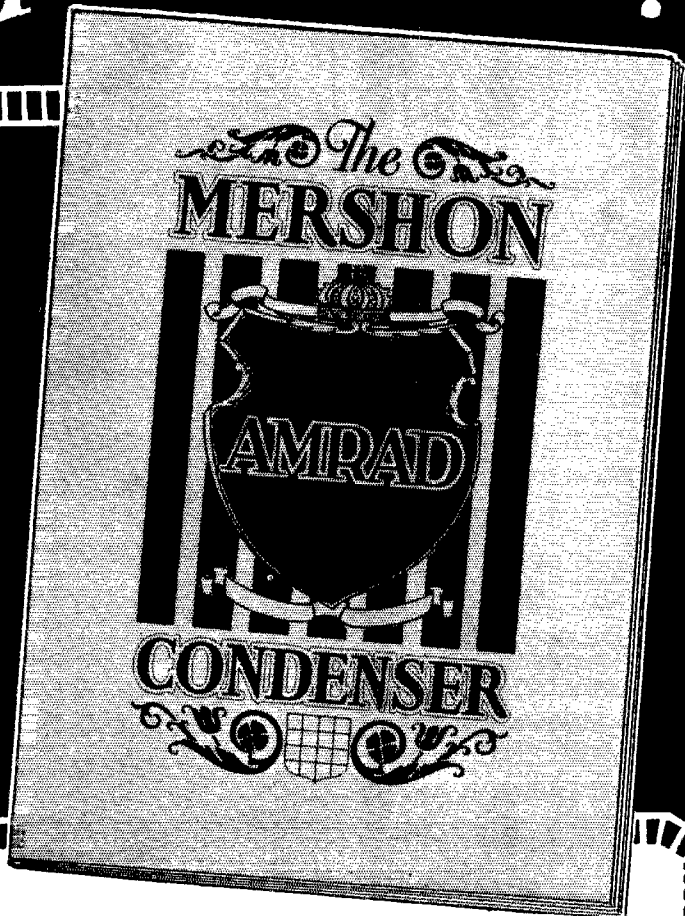

For "B" Eliminators, Power Supply and Filter Circuits, nothing compares to the Amrad Mershon Condenser, which is self-healing, absolutely unaffected by weather conditions, and has extremely high capacity in extremely small space.

Let us send our new book, showing hook-up and explaining the many uses of Mershon. Address Department 28

The AMRAD Corporation
Medford Hillside, Mass.

J. E. HAHN,
President

POWEL CROSLY, JR.
Chairman of the Board

AERO COIL

SUPER-SENSITIVE

INDUCTANCE UNITS

The Perfect Inductances for All Low Wave Work

**FOR
RECEIVING**

AERO LOW WAVE TUNER KIT

Price \$12.50

Completely interchangeable. Adopted by experts and amateurs everywhere. Range 15 to 130 meters. Includes 3 coils and base mounting, covering U.S. bands. 20, 40 and 80 meters. You can increase or decrease the range of this

short wave tuner by securing the AERO Interchangeable Coils described below. All coils fit the same base and use the same condensers. Use Code No. INT-125 in ordering.

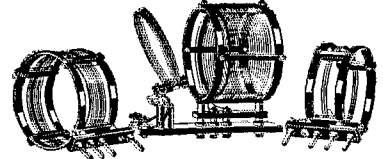

PRICE \$12.50

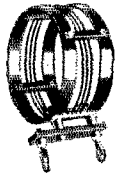

INTERCHANGEABLE Coil No. 0

Range 13 to 29.4 meters. This is the most efficient inductance for this low band. Code number INT-0.

Price \$4.00

INTERCHANGEABLE Coil No. 4

Range 125 to 250 meters. Fits same base supplied with low tuner kit. Code number INT-No. 4.

Price \$4.00

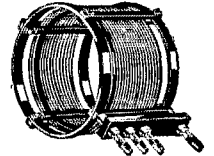

THE NEW AERO INTERCHANGEABLE COIL No. 5

Normal range 235 to 550 meters. However, by using .0001 Sangamo fixed condenser across the rotor and stator of the .00014 variable condenser, the maximum wave band of this coil is increased to 725 meters. This gives you coverage of the following bands: Airplane to Airplane, Land to Airplane, Ship to Shore (Great Lakes) Ship to Shore (Atlantic and Pacific Oceans). Code number INT-No. 5.

Price \$4.00

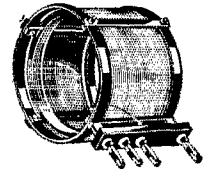

NOTE This new Aero Short Wave Kit is wound with No. 16 wire on secondary, making it even stronger, and cutting down the resistance appreciably.

**FOR
TRANSMIT-
TING**

KEY 2040 KIT

Price \$12.00

Kit contains 2 AERO Coils, 17 to 50 meters each, 1 AERO Antenna Coil Mounting Base, 1 AERO Grid Coil Mounting Base, 2 AERO Essential Choke Coils.

KEY 4080 KIT

Price \$12.00

Kit contains 2 AERO Coils, 36 to 90 meters each, 1 AERO Antenna Coil Mounting Base, 1 AERO Grid Coil Mounting Base, 2 AERO Essential Choke Coils.

KEY 9018 KIT

Price \$12.00

Completely interchangeable with either of above kits. Range 90 to 180 meters. Contains 2 coils and mounting base.

COMPLETE AERO TRANSMITTER KITS

Complete Aero Transmitting Coils for the 20-40 and 40-80 bands, \$26.00. Complete for 20-40, 40-80, and 90-180 bands, \$28.00.

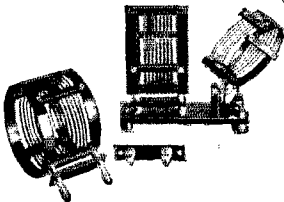
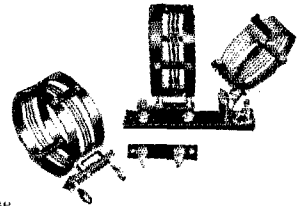

AERO PARTS

Transmitter coils (17 to 50 meters, Key 2040C, 36 to 90 meters, Key 4080C and 90 to 180 meters, Key 9018C) \$4.00 ea. Antenna Base, Key PRI-300, \$3.00 ea. Grid Coil Base, Key GRID-100, \$1.00 ea. Choke Coils, \$1.50 ea.

PLAN FOR D. X. RECORDS NOW!

Order these coils direct from us if your dealer hasn't them and start now for wonderful records. Specify code or key numbers when ordering. Or write at once for complete descriptive literature.

AERO PRODUCTS, Inc.

Dept. 16

1772 WILSON AVE., CHICAGO, ILL.



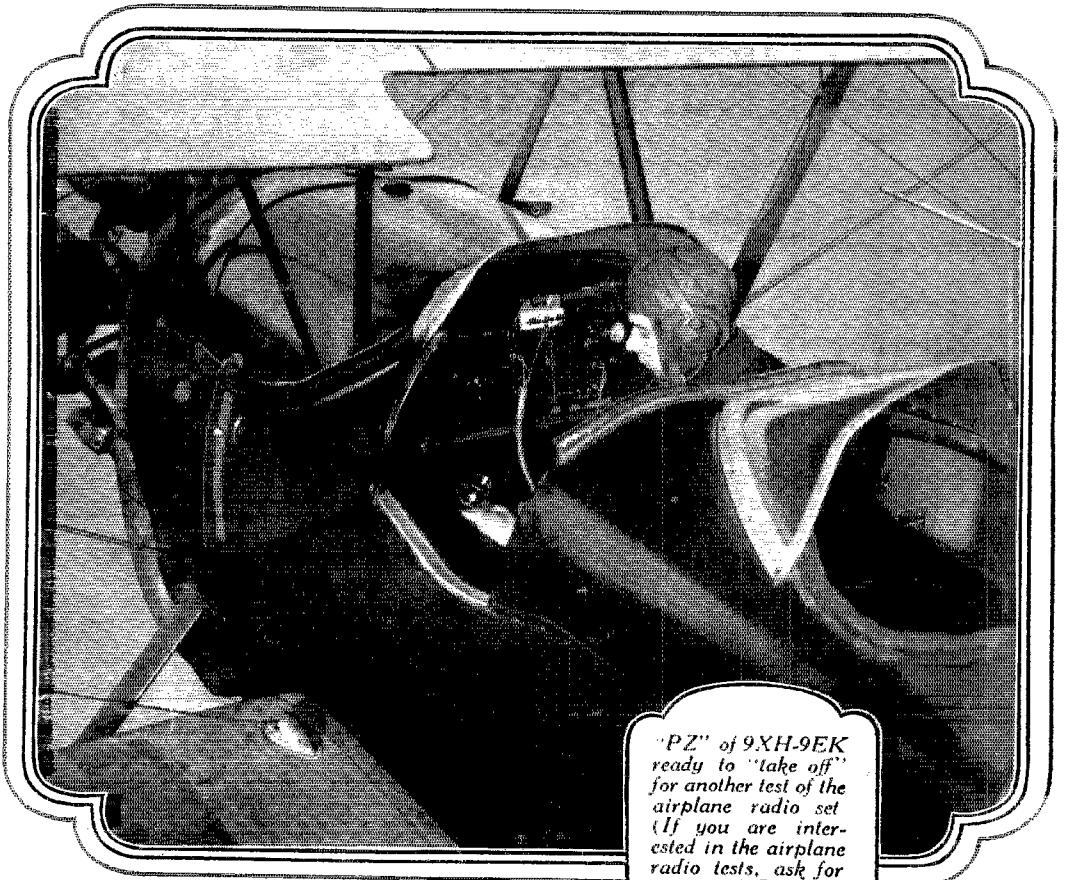

"PZ" of 9XH-9EK
 ready to "take off"
 for another test of the
 airplane radio set
 (If you are interested
 in the airplane
 radio tests, ask for
 a copy of Engineering
 Circular No 15)

FOR years the Burgess Organiza-
 tions have been doing a great
 deal of experimental and research
 work looking toward the advance-
 ment of radio art. The aircraft radio
 communication tests on high fre-
 quency, recently conducted by
 9XH-9EK, while somewhat spec-
 tacular brought out some hereto-
 fore unknown phe-
 nomena. All of this
 information as well
 as the results of
 many other experi-
 ments of interest

Ask Any

and value have been made avail-
 able, in the form of Burgess Engi-
 neering Circulars distributed freely,
 to those who are interested in ex-
 perimentation.

We feel that some of this work has
 resulted in real benefit to radio in
 general and to the radio amateur in
 particular and what-
 ever measure of suc-
 cess our work has
 had is a spur to re-
 newed efforts along
 these lines.

Radio Engineer"

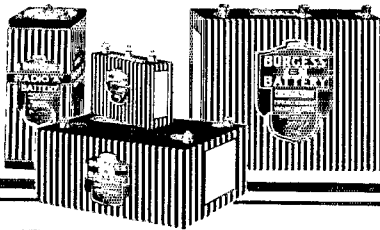

BURGESS BATTERY COMPANY

MADISON,

WISCONSIN